



# GOODSON

## Tools and Supplies for Engine Builders

# 2015

## 70th Anniversary

# Goodson

Tools & Supplies for Engine Builders

## 1945 - 2015

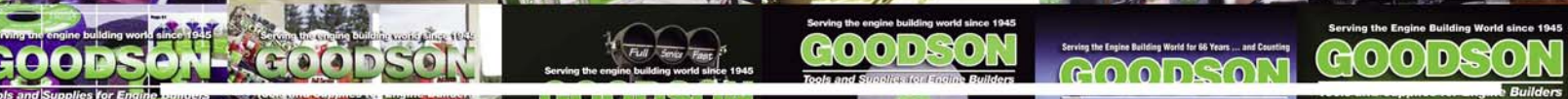

Toll-Free 800-533-8010 • Phone 507-452-1830 • [www.goodson.com](http://www.goodson.com)



# From the President's Desk

Looking back through our catalog collection and our business timeline is a nostalgic trip to be sure. It's enjoyable to see how people have changed and to see how the Goodson product line has evolved.

The pivotal point of this evolution came when Scott Biesanz bought Goodson Tools in 1979 and transformed it into the company it is today — a service-oriented company that takes pride in providing the best guarantee in the business, the most innovative products and of course, **Full Service ... Fast!**

All of us at Goodson look forward to serving your shop supply needs for many years to come. Look to Goodson to continue bringing you the newest products as well as forging new partnerships to enhance our ability to serve you at a higher level with a wider selection of products and innovations.

Thank you for placing your trust in us on a daily basis. We are excited to celebrate Goodson being in business for 70 years ... with you.

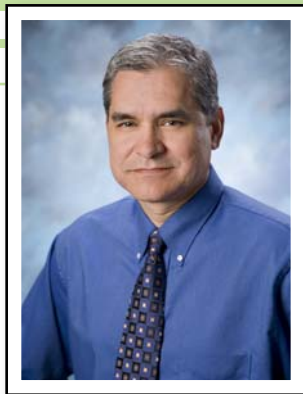

Juan Roque,  
Goodson President



## Do you have an idea for our next great tool?

Many of the ideas for our most successful product introductions have come from you, the guys in the shops.

You work in this industry and have come up with some very creative solutions to everyday problems.

Call Dave Monahan at Goodson to learn more about having Goodson produce and market your idea to the automotive aftermarket. Who knows? Yours could be the next big idea that Goodson brings to market.

Contact Dave Monahan at **1-800-533-8010** today.

## GOODSON Ironclad Guarantee

Goodson won't risk

losing your business for any

reason. If you're not 100% satisfied with your purchase, we'll fix it, exchange it or credit your account for the purchase price. To send an item back, just include a note detailing the reason for the return and ship it back, freight pre-paid within 60 days. The only time we can't honor this guarantee is if a tool has been damaged through misuse or modification. All abrasives have a shelf life so we can only guarantee them

for one year from the original purchase date.



Erik Shepard

## Goodson Techxperts™ on staff to help you

When you have questions about product applications, tooling interchangeability, machining procedures, extending tool life, engine specs or any other technical topic, give the Goodson Tech Services Department a call at **1-800-533-8010**.



Chris Jensen

## Contact Us



Customer service representatives are available from 7:30am - 5:30pm, Mon. - Fri. and our Techxperts™ are on hand from 8am - 5pm, Mon. - Fri. (Central time)

**Phone:** 1-800-533-8010 (US & Canada)  
1-507-452-1830 (International)

**Fax:** 1-888-466-3909 (US & Canada)  
1-507-452-2907 (International)

Please note that the Goodson offices will be closed in observance of the following 2015 holidays: New Years Day (January 1), Memorial Day (May 25), Independence Day (July 3), Labor Day (September 7), Thanksgiving (November 26 & 27), Christmas (December 24 & 25) and New Year's Eve (December 31).

**We're always open on the web!**

**Web:** [www.goodson.com](http://www.goodson.com)

**Email:** [orderdesk@goodson.com](mailto:orderdesk@goodson.com)

## Policies

See the last page of the **Index** for more information about these policies.

### Pricing:

**Prices are subject to change without notice.** There is no minimum order. Orders are billed at the prices in effect at the time of shipping. Discounts are not available on Sunnen® products.

### Shipping:

Goodson ships orders the same day they are received. Orders received after hours, on weekends or holidays are shipped the next business day. If your order is lost in shipping, Goodson works with the shipper to provide tracking service. Please inspect all shipments upon receipt and report damage or errors within 48 hours.

### Freight:

For orders shipped ground within the USA, you may deduct the freight charges on any jobber net invoice of \$800 or more if you pay within 30 days of the invoice date. Glass Beads, Steel Shot, Tumbler Media, Machines, Equipment, Bulk Liquids and Crankwheels are not included. Hazardous Materials, Dangerous Goods & Dimensional Shipping fees may apply on some items.

### Terms:

- 1) A 1% discount is given on merchandise if payment is made within 15 days from invoice date. This discount applies to the merchandise amount only (not the total amount) on the invoice (not a statement). The discount amount is shown in the lower left hand corner of the invoice. This discount does not apply to statement payments and does not apply to credit card orders.
- 2) Invoices not paid in full within 30 days from the statement date are subject to a finance charge of 1.5% per month (18% per year).

### Credit & Debit Card Orders:

Goodson accepts MasterCard, Visa, American Express and Discover Card. For your security, credit card numbers are **NOT** kept on file. Credit card orders do not qualify for the 1% quick-pay discount.

### Check Acceptance:

In the unlikely event that your check is returned for insufficient or held funds, we will debit your checking account electronically for the face amount of the check plus the service fee allowed by your state's law. This allows us to resolve the problem without turning you over to a collection agency and harming your credit rating. The transaction will appear on your bank statement and no one will have to contact you about payment.

### Returns:

You may return any item, except special orders, within 60 days. We will do our best to correct any problems or to send a replacement. If an item was damaged through mis-use or modification, Goodson will not accept it as a return. Credits will only be issued after it is determined that the part is resellable or it is deemed defective.

**ABRASIVES WARRANTY:** Abrasives have a shelf-life, therefore, all abrasives are warranted against manufacturing defects for 1 year from the date of original purchase.

**RESETTING/RESHARPENING SERVICE:** Premium Diamonds can be reset and many of our cutting tools can be resharpened. Send your resets and sharps to **GOODSON Tools & Supplies, ATTN: Resharps**, 156 Galewski Dr. Winona, MN 55987. Be sure to include your customer number.

A rapid-use index of **product categories**

## Cylinder Head Rebuilding

Pilots .....	1-3
Valve Seat Work .....	4-21
Valve Refacing .....	22-23
Reamers .....	24-25
Valve Guide Resizing .....	26-28
Valve Guide Replacement .....	29-34
Valve Seal Work .....	35
Valve Spring Work .....	36-42
Cylinder Head Resurfacing .....	43-46
Crack Detection & Repair .....	47-51
Valve Adjustment Discs .....	55
Porting & Polishing .....	57-60

## Cleaning, Assembly & Safety

Cleaning .....	63-68
Wire Wheels & Brushes .....	62-63
Parts Baskets .....	68
Parts Storage & Organizers .....	61, 69
Last Blast Paint & Metal Markers .....	70
Flex-Hones® .....	72

## Index

.....Falls between pages 72 & 73

Coolants & Lubricants .....

.....	73
-------	----

## Short Block Rebuilding

Cylinder Boring & Honing .....	74-80
Boring Bar Tooling & Supplies .....	74-75
Honing Stones .....	76-80
Rod Honing .....	82-83
Rod & Piston Work .....	84-89
Lifter Bore Tooling .....	91
Camshaft Work .....	92-93

## Crankshaft/Flywheel Grinding

Crankshaft Grinding Wheels .....	94-95
Crankshaft Grinding & Polishing .....	96-100
Flywheel Grinding .....	101-103

## Miscellaneous Tools

Diamond Dresser Tools .....	104-105
Machine Replacement Parts .....	107-109
Technical Manuals & Videos .....	109

## Brake & Tire Changing Tools

Brake Tips & Holders .....	110-111
Brake Lathe Silencers .....	112
Brake Lathe Replacement Parts .....	113-117
Brake Lathe Mounting Adaptors .....	116-117
Tire Changing & Balancing .....	118-119

## Measuring Tools

Calipers & Dial Indicators .....	120
Micrometers .....	121
Dial Bore Gauges .....	122, 124

## V-Twin & Metric Hard Parts

Seats & Seat Inserts .....	125
Valve Guides .....	126
Replacement Valves .....	127
Valve Springs .....	128-129

© Copyright 2015, Goodson Mfg. Co., Inc. All copy and illustrations are copyrighted. Absolutely no mechanical or electronic reproduction or use of any part is allowed without our prior written permission. Goodson reserves the right to correct printing errors. Prices are subject to change without notice.

CYLINDER HEAD REBUILDING  
CLEANING, ASSEMBLY & SAFETY  
SHORT BLOCK REBUILDING  
CRANKSHAFT/ FLYWHEEL GRINDING  
MISCELLANEOUS TOOLS & SUPPLIES  
BRAKE & TIRE CHANGING TOOLS  
MEASURING TOOLS  
V-TWIN & METRIC HARD PARTS



**American Made**

Hex Drive Seat Grinding Kit includes everything listed below. Everything comes packed in a handy storage case.



**Valve Seat Grinding Sets**

Order the set as-is or modify a set to meet your specific needs. Set contents include:

Description	OE Number	Jobber	Order No.	Includes		
45° Hex Drive Motor Seat Grinding Set (110V, 50/60 Hz)		\$ 4,199.99	SGH-110-KIT	▼		
45° Hex Drive Motor Seat Grinding Set (220V, 50/60Hz)		4,299.99	SGH-220-KIT	▼		
Flex Drive Motor Seat Grinding Set (110V, 50/60 Hz)		4,399.99	SGF-110-KIT	▼		
Flex Drive Motor Seat Grinding Set (220V, 50/60Hz)		4,499.99	SGF-220-KIT	▼		
Hex Drive Seat Grinder - 45° 110V, 50/60Hz	031-3100-20	1,299.99	031-3100-20	1		
Hex Drive Seat Grinder - 45° 220V, 50/60Hz	031-3100-27	1,399.99	031-3100-27	1		
Flex Drive Seat Grinder 110V, 50/60Hz	031-3000-15	1,399.99	031-3000-15	1		
Flex Drive Seat Grinder 220V, 50/60Hz	031-3000-35	1,499.99	031-3000-35	1		
Heavy Duty Wheel Dresser w/G-18 Diamond	031-1900-02	1,129.99	031-1900-02	1 1 1 1		
Replacement Dressing Stand Diamond	031-1102-89	34.99	G-18			
Dressing Stand Pilot with .437" Top	031-0202-80	149.99	031-0202-80	1 1		
Dressing Stand Pilot with .437" Top	031-1102-89	149.99	031-1102-89	1 1		
Stone Holder - 13/16" x 13 Thread w/Plunger	031-0300-30	379.99	031-0300-30	2 2		
Flex-Drive Stone Holder with Stabilizer	031-0300-64	399.99	031-0300-64	2 2		
Heavy Duty Plastic Storage Box	001-1000-25	49.99	SG-CASE	1 1 1 1		
Seat Stone Removal Tool	n/a	24.99	KW-SRT	1 1		
Leather Washer / Vibration Reducer (3 Pc.)	031-1009-41	11.99	KHW-3	1 1 1 1		
<b>.437" Top Pilots</b>	<b>Dia./mm</b>					
	.2755" / 7.00mm	\$57.99	P-5275K	1 1 1 1		
	.2763" / 7.02mm	57.99	P-5277K	1 1 1 1		
	.2775" / 7.05mm	57.99	P-5278K	1 1 1 1		
	.3125" / 7.93mm	57.99	P-5312K	1 1 1 1		
	.3135" / 7.96mm	57.99	P-5313K	1 1 1 1		
	.3145" / 7.98mm	57.99	P-5314K	1 1 1 1		
	.3149" / 8.00mm	57.99	P-5315K	1 1 1 1		
	.3437" / 8.72mm	57.99	P-5343K	1 1 1 1		
	.3447" / 8.75mm	57.99	P-5344K	1 1 1 1		
	.3457" / 8.78mm	57.99	P-5345K	1 1 1 1		
	.3730" / 9.47mm	57.99	P-5373K	1 1 1 1		
	.3750" / 9.52mm	57.99	P-5375K	1 1 1 1		
<b>General Purpose Valve Seat Grinding Stones (1/8"x13)</b>						
			<b>30°</b>			
			<b>45°</b>			
1.375" / 35mm	\$13.99	KW-1130-GP	1 1 1 1	\$13.99	KW-1145-GP	1 1 1 1
1.500" / 38mm	13.99	KW-1230-GP	1 1 1 1	13.99	KW-1245-GP	1 1 1 1
1.615" / 41mm	13.99	KW-1330-GP	1 1 1 1	13.99	KW-1345-GP	1 1 1 1
1.750" / 44mm	13.99	KW-1430-GP	1 1 1 1	13.99	KW-1445-GP	1 1 1 1
1.785" / 47mm	13.99	KW-1530-GP	1 1 1 1	13.99	KW-1545-GP	1 1 1 1
2.000" / 51mm	13.99	KW-1630-GP	1 1 1 1	13.99	KW-1645-GP	1 1 1 1
2.125" / 54mm	13.99	KW-1730-GP	1 1 1 1	13.99	KW-1745-GP	1 1 1 1
<b>Finishing Valve Seat Grinding Stones (1/8"x13)</b>						
			<b>30°</b>			
			<b>45°</b>			
1.375" / 35mm	\$13.99	KW-1130-F	1 1 1 1	\$13.99	KW-1145-F	1 1 1 1
1.500" / 38mm	13.99	KW-1230-F	1 1 1 1	13.99	KW-1245-F	1 1 1 1
1.625" / 41mm	13.99	KW-1330-F	1 1 1 1	13.99	KW-1345-F	1 1 1 1
1.750" / 44mm	13.99	KW-1430-F	1 1 1 1	13.99	KW-1445-F	1 1 1 1
1.785" / 47mm	13.99	KW-1530-F	1 1 1 1	13.99	KW-1545-F	1 1 1 1
2.000" / 51mm	13.99	KW-1630-F	1 1 1 1	13.99	KW-1645-F	1 1 1 1
2.125" / 54mm	13.99	KW-1730-F	1 1 1 1	13.99	KW-1745-F	1 1 1 1

**45° Kwik-Way Hex Drive (SGH) Electric Motor Unit**

- Heavy duty electric motor
- 11,500 RPM
- Weighs 9 lbs.
- 3/5 HP, 7.5 Amps

Description	Jobber	Order No.
110V, 50/60Hz	\$1,299.99	031-3100-20
220V, 50/60Hz	1,399.99	031-3100-27



**Flex Drive (SGF) Heavy Duty Electric Motor Unit**

- Heavy duty electric motor
- Flex Drive allows for slight operator misalignment
- 11,500 RPM
- 3/5 HP, 7.5 Amps
- Must use with Flex Stone Holder (031-0300-64)

Description	Jobber	Order No.
110V, 50/60Hz	\$1,399.99	031-3000-15
220V, 50/60Hz	1,499.99	031-3000-35

**Goodson is now the exclusive manufacturer of Kwik-Way Valve Seat Grinding Equipment and Tooling!**

Goodson is now manufacturing the seat grinding tools and tooling, that Goodson recently purchased from Kwik-Way. As part of our commitment to you, Goodson has upgraded the manufacturing process as well as all bearings, improving the over-all quality of every component.

**KWIK-WAY**  
Seat Grinding Equipment & Supplies

MFG BY

**GOODSON**  
Tools and Supplies for Engine Builders



**Sioux-Style Valve Seat Grinding Kits**

These kits include everything you need to get started in seat grinding. Choose between kits including 110V and 220V Spline Drive Electric Grinders. After that, everything else in the kit is identical.

We started with the most common sizes of pilots and valve seat stones, but you can customize one of these kits to meet your specific needs. Call 1-800-533-8010 for additional information.

Description	OE Number	Jobber	Order No.	Includes
<b>45° Spline Drive Motor Seat Grinding Set (110V, 50/60 Hz)</b>		\$ 2,999.99	<b>SGK-110-KIT</b>	
<b>45° Spline Drive Motor Seat Grinding Set (220V, 50/60Hz)</b>		3,099.99	<b>SGK-220-KIT</b>	
Seat Grinding Kit Without Driver	n/a	1,699.99	<b>SGK-385</b>	
Spline Drive Seat Grinder - 45° 110V, 50/60 Hz	031-3100-21	1,329.99	<b>031-3100-21</b>	1
Spline Drive Seat Grinder - 45° 220V, 50/60 Hz	031-3100-28	1,499.99	<b>031-3100-28</b>	1
Universal Seat Wheel Dresser w/G-13P Diamond	n/a	599.99	<b>SWD-UNI</b>	1 1 1
Replacement Dressing Diamond	n/a	76.29	<b>G-13P</b>	
Stone Holder - 1/8" x 16 Thread	1702	169.99	<b>SG-HOLDER</b>	2 2 2
Heavy Duty Plastic Storage Box	001-1000-25	49.99	<b>SG-CASE</b>	1 1 1
Seat Stone Removal Tool	n/a	24.99	<b>SX-SRT</b>	1 1 1
Bounce Spring Set (3 Pc.)	n/a	16.99	<b>BSS-100</b>	1 1 1
Leather Washer / Vibration Reducer (3 Pc.)	031-1009-41	11.99	<b>SHW-3</b>	1 1 1

.385" Top Pilots	Dia./mm						
	.2755" / 7.00mm		\$57.99	<b>P-5275S</b>	1	1	1
	.2763" / 7.02mm		57.99	<b>P-5277S</b>	1	1	1
	.2775" / 7.05mm		57.99	<b>P-5278S</b>	1	1	1
	.3125" / 7.93mm		57.99	<b>P-5312S</b>	1	1	1
	.3135" / 7.96mm		57.99	<b>P-5313S</b>	1	1	1
	.3145" / 7.98mm		57.99	<b>P-5314S</b>	1	1	1
	.3149" / 8.00mm		57.99	<b>P-5315S</b>	1	1	1
	.3437" / 8.72mm		57.99	<b>P-5343S</b>	2	2	2
	.3447" / 8.75mm		57.99	<b>P-5344S</b>	1	1	1
	.3457" / 8.78mm		57.99	<b>P-5345S</b>	1	1	1
	.3750" / 9.52mm		57.99	<b>P-5375S</b>	1	1	1
	.3780" / 9.60mm		57.99	<b>P-5378S</b>	1	1	1

General Purpose Seat Grinding Stones (1/8"x16)		30°		45°		
1.375" / 35mm	\$13.99	<b>SX-1130-GP</b>	1 1 1	\$13.99	<b>SX-1145-GP</b>	1 1 1
1.500" / 38mm	13.99	<b>SX-1230-GP</b>	1 1 1	13.99	<b>SX-1245-GP</b>	1 1 1
1.625" / 41mm	13.99	<b>SX-1330-GP</b>	1 1 1	13.99	<b>SX-1345-GP</b>	1 1 1
1.750" / 44mm	13.99	<b>SX-1430-GP</b>	1 1 1	13.99	<b>SX-1445-GP</b>	1 1 1
1.785" / 47mm	13.99	<b>SX-1530-GP</b>	1 1 1	13.99	<b>SX-1545-GP</b>	1 1 1
2.000" / 51mm	13.99	<b>SX-1630-GP</b>	1 1 1	13.99	<b>SX-1645-GP</b>	1 1 1
2.125" / 54mm	13.99	<b>SX-1730-GP</b>	1 1 1	13.99	<b>SX-1745-GP</b>	1 1 1

Finishing Valve Seat Grinding Stones (1/8"x16)		30°		45°		
1.375" / 35mm	\$13.99	<b>SX-1130-F</b>	1 1 1	\$13.99	<b>SX-1145-F</b>	1 1 1
1.500" / 38mm	13.99	<b>SX-1230-F</b>	1 1 1	13.99	<b>SX-1245-F</b>	1 1 1
1.625" / 41mm	13.99	<b>SX-1330-F</b>	1 1 1	13.99	<b>SX-1345-F</b>	1 1 1
1.750" / 44mm	13.99	<b>SX-1430-F</b>	1 1 1	13.99	<b>SX-1445-F</b>	1 1 1
1.785" / 47mm	13.99	<b>SX-1530-F</b>	1 1 1	13.99	<b>SX-1545-F</b>	1 1 1
2.000" / 51mm	13.99	<b>SX-1630-F</b>	1 1 1	13.99	<b>SX-1645-F</b>	1 1 1
2.125" / 54mm	13.99	<b>SX-1730-F</b>	1 1 1	13.99	<b>SX-1745-F</b>	1 1 1



**45° Sioux-Style (SGK) Spline Drive Electric Motor Unit**

- Heavy duty electric motor
- 11,500 RPM
- Weighs 9 lbs.
- 3/5 HP • 7.5 Amps

Description	Jobber	Order No.
110V, 50/60Hz	\$1,329.99	<b>031-3100-21</b>
220V, 50/60Hz	1,499.99	<b>031-3100-28</b>



034-3112-00

031-3112-17

**Replacement Drive Assemblies**

- Easy to install
- Always keep one on hand for emergencies

Description	Jobber	Order No.
Spline Drive	\$74.99	<b>034-3112-00</b>
Hex Drive w/Leather Washer	74.99	<b>031-3112-17</b>
Replacement Leather Washer	3.99	<b>031-1009-41</b>

CYLINDER HEAD REBUILDING  
CLEANING, ASSEMBLY & SAFETY  
SHORT BLOCK REBUILDING  
FLYWHEEL GRINDING  
CRANKSHAFT/ MISCELLANEOUS TOOLS & SUPPLIES  
BRAKE & TIRE CHANGING TOOLS  
MEASURING TOOLS  
V-TWIN & METRIC HARD PARTS

Dresser Pilot sold separately  
See chart below for complete selection

## Heavy Duty Valve Seat Wheel Dresser

- Ball bearing mounted diamond carrier
- Adjustable in 1° increments from 0° to 90°
- Includes diamond
- Order dressing pilot separately from list below
- Designed for maximum accuracy



**American Made**

Description	Jobber	Order No.
Heavy Duty Dresser	\$1,129.99	031-1900-02
Replacement Diamond Dresser	34.99	G-18

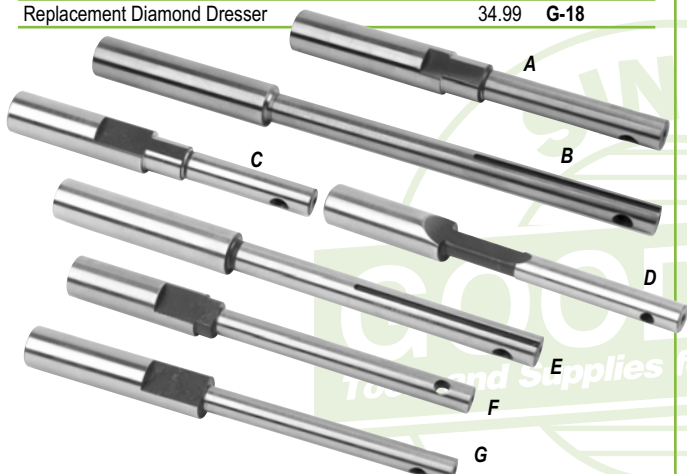

Dresser Pilots (select based on stone holder type)			
Fits Stone Holder Type	OAL	Jobber	Order No.
A .437" Hex Stone Holder	5 1/8"	\$149.99	031-1102-89
B .437" Hex Stone Holder	8 1/2"	149.99	031-0202-71
C .406" Hex Stone Holder	4 1/8"	149.99	031-1102-03
D .406" Hex Stone Holder	5 1/2"	149.99	031-1102-38
E .437" Hex or Flex Stone Holder	7 1/4"	149.99	031-0202-80
F .385" Top Stone Holder	6"	149.99	031-0202-55
G .375" Top Stone Holder	6 1/2"	149.99	031-0202-47

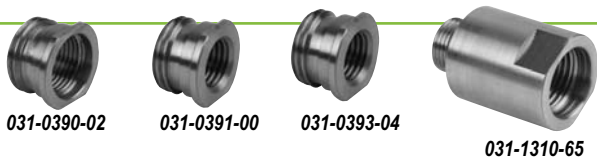

## Grinding Wheel Adaptors

Description	Jobber	Order No.
1 1/8"-13 (KW) Threaded Stones to 1 1/8"-16 Threaded Holders (Sioux™, KO Lee)	\$59.99	031-0390-02
1 3/8"-13 (KW) Threaded Stones to 3/8"-16 Threaded Holders (Black & Decker)	59.99	031-0391-00
1 3/8"-13 (KW) Threaded Stones to 2 1/2"-18 Threaded Holders (Kwik-Way)	59.99	031-0393-04
2 1/2"-18 (KW) Threaded Stones to 1 3/8"-13 Threaded Holders (Kwik-Way) requires 031-0202-71 Dresser Pilot (above)	59.99	031-1310-65



## Kwik-Way 45° Hex Drive (SGH) Electric Motor Unit

- Heavy duty electric motor
- 11,500 RPM • Weighs 9 lbs. • 3/5 HP • 7.5 amps
- Use with Hex Drive Stone Holders (below & page 21)

Description	Jobber	Order No.
110V, 50/60Hz	\$1,299.99	031-3100-20
220V, 50/60Hz	1,399.99	031-3100-27
Nose Cone Assembly	679.99	031-3105-12
Hex Drive Assembly with Leather Washer	74.99	031-3112-17

## .437" Top Pilot Hex Drive Stone Holders

- Balanced body runs on ball bearings around a stationary inner sleeve
- Sleeve is keyed to the pilot preventing rotation, vibration & friction
- Now Includes heavy duty bearings for smoother operation and longer life
- Leather washer included to prevent stone from siezing to holder
- Rebuildable



Description	Jobber	Order No.
Stone Holder w/o plunger	\$349.99	031-0300-56
Stone Holder with plunger	379.99	031-0300-30

More Stone Holders on page 21

## Rebuild Kit For Hex Drive Stone Holder Without Plunger

- For 031-0300-56 Stone Holder
- Includes 2 Bearings, Bearing Sleeve, Sleeve Key, Bearing Lock Nut, Hex Cap & Garter Spring (individual components are NOT available)
- Order No. **034-0002-00** Jobber \$189.99



## Rebuild Kit For Hex Drive Stone Holder With Plunger

- For 031-0300-30 Stone Holder
- Includes 2 Bearings, Bearing Sleeve, Sleeve Key, Bearing Lock Nut, Hex Cap & Spring Plunger Assembly (individual components are NOT available)
- Order No. **034-0002-15** Jobber \$199.99





### Flex Drive (SGF) Heavy Duty Electric Motor Unit

- Heavy duty electric motor
- Flex Drive allows for slight operator misalignment
- 11,500 RPM • 3/5 HP • 7.5 amps
- Use with Flex-Drive Stone Holder (below)

Description	Jobber	Order No.
110V, 50/60Hz	\$1,399.99	031-3000-15
220V, 50/60Hz	1,499.99	031-3000-35
Nose Cone Assembly	679.99	031-3005-17



### .437" Top Pilot Flex Drive Stone Holder

- Balanced body runs on ball bearings around a stationary inner sleeve
- Sleeve is keyed to the pilot, preventing rotation, vibration and friction • Stone holders are rebuildable

Description	Jobber	Order No.
Flex Drive Holder with Stabilizer & Coupling	\$399.99	031-0300-64
Flex Drive Holder with Coupling	389.99	031-0300-80
Flex Drive Holder only	349.99	031-0300-85
Heavy Duty Twisted Cable Steel Coupling	79.99	031-0304-10
Stabilizer Assembly with Bushing	49.99	031-0126-60

**Goodson  
exclusive**



### 45° (SGK) Sioux-Style Spline Drive Electric Motor Unit

- Heavy duty electric motor
- 11,500 RPM • Weighs 9 lbs. • 3/5 HP • 7.5 amps
- Use with SX Stone Holder (page 21)

Description	Jobber	Order No.
110V, 50/60Hz	\$1,329.99	031-3100-21
220V, 50/60Hz	1,499.99	031-3100-28
Nose Cone Assembly	679.99	034-3105-00
Replacement Spline Drive Assembly	74.99	034-3112-00

### Rebuild Kit For Flex Drive Stone Holder

- For 031-0300-85 Stone Holder
- Includes 2 Bearings, Bearing Sleeve, Heavy Duty Flex Coupling, Inner Sleeve Key & Set Screw (components are NOT available individually)
- Order No. 034-0003-25  
Jobber \$199.99



### WAKE UP YOUR DIESEL

- Increase Low Lift Air Flow
- Increase Torque
- Increase Horsepower



### Black Smoke Series Seat Cutters for High Performance Diesel Engines

Developed for Goodson by Joe Mondello Racing Engines  
Jobber \$39.99 each

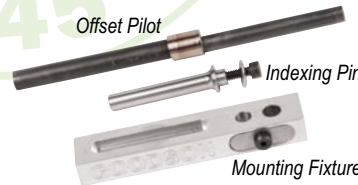
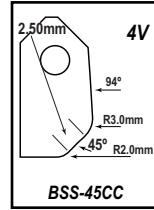
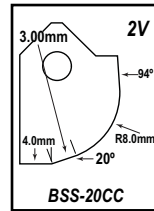
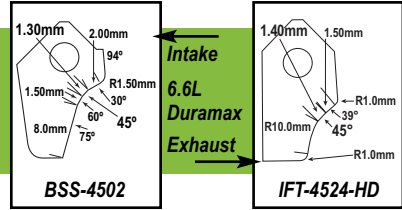
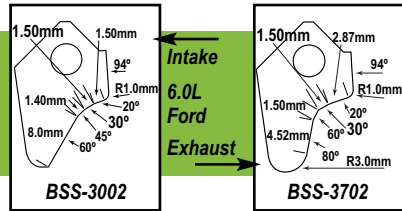
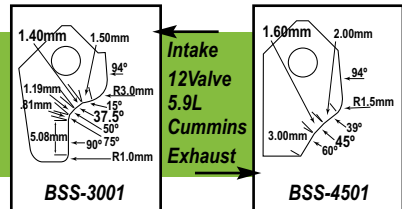
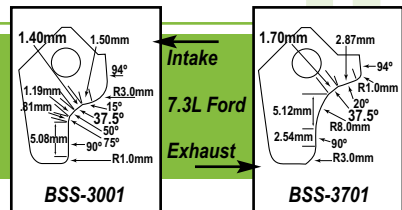

Proper set-up of the Diesel Relief Tool



- Use with your seat and guide machine or Bridgeport Mill equipped with a multi-angle seat cutting system
- Developed for Goodson by Joe Mondello Racing Engines
- Use for 6.0L & 7.3L Ford, 12 Valve, 5.9L Cummins and 6.6L Duramax diesel engines
- For 2-Valve and 4-Valve heads
- Complete kit includes the Mounting Fixture, Offset Pilot, Indexing Pin and a Radius Cutter
- This tool is only for use with radius cutters BSS-20CC and BSS-45CC

Description	Jobber	Order No.	Incl.
7mm Diesel Relief Tool Kit	\$169.99	DVRT-7MM-KIT	▼
8mm Diesel Relief Tool Kit	169.99	DVRT-8MM-KIT	▼
20CC Radius Cutter for 2-Valve Heads	39.99	BSS-20CC	x
45CC Radius Cutter for 4-Valve Heads	39.99	BSS-45CC	x

CYLINDER HEAD  
BLEEDING  
ASSEMBLY & SAFETY  
CLEANING  
SHORT BLOCK  
REBUILDING  
FLYWHEEL GRINDING  
CRANKSHAFT/  
MISCELLANEOUS  
TOOLS & SUPPLIES  
BRAKE & TIRE  
CHANGING TOOLS  
MEASURING  
TOOLS  
V-TWIN & METRIC  
HARD PARTS

CYLINDER HEAD REBUILDING  
CLEANING, ASSEMBLY & SAFETY  
SHORT BLOCK REBUILDING  
CRANKSHAFT/ FLYWHEEL GRINDING  
MISCELLANEOUS TOOLS & SUPPLIES  
BRAKE & TIRE CHANGING TOOLS  
MEASURING TOOLS  
V-TWIN & METRIC HARD PARTS

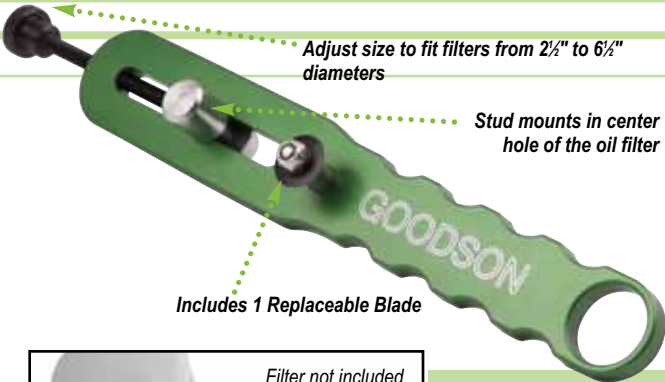

Adjust size to fit filters from 2½" to 6½" diameters

Stud mounts in center hole of the oil filter

Includes 1 Replaceable Blade



Filter not included

After running a race, you should run a flow test, but this can be expensive and take time. Cutting open the used oil filter with the Oil Filter Inspection Tool is the next best thing.

Most filters will trap anything larger than 24 to 30 microns (though some will trap particles as small as micron). When you inspect the oil filter, you can actually see what's getting trapped. This can be anything from silicone sealants to broken mechanical parts to worn materials and more. Metal shavings can point toward mechanical problems that could cause total engine failure.

### Oil Filter Inspection Tool

- Check for contaminants with every oil change
- Cut open the filter canister for inspection
- Fits 2½" to 6½" diameter filters
- Includes a single blade

Description	Jobber	Order No.
Oil Filter Inspection Tool	\$54.99	<b>FIT-1-G</b>
Replacement Cutter Blade	11.99	<b>FIT-W</b>

**American Made**

Heavy-duty universal joint

Easy to adjust to fit cylinders up to 5½"

Use with HN- and AN-style honing stones



stones sold separately

### Goodson Heavy-Duty Portable Cylinder Hone

- Hone cylinders ranging from 2½" - 5½"
- Includes a 2" drive shank and a 12" extension
- Heavy-duty universal joint
- Use with any HN- or AN-style honing stones (sold separately, see pg. 77)
- ½" - 11 thread
- Includes a heavy-duty plastic storage box
- Use with ½" non pistol-grip drill or manual hone cabinet
- Shippable Worldwide
- Order No. **GH-2555** Jobber \$549.99



WorldwideShipping

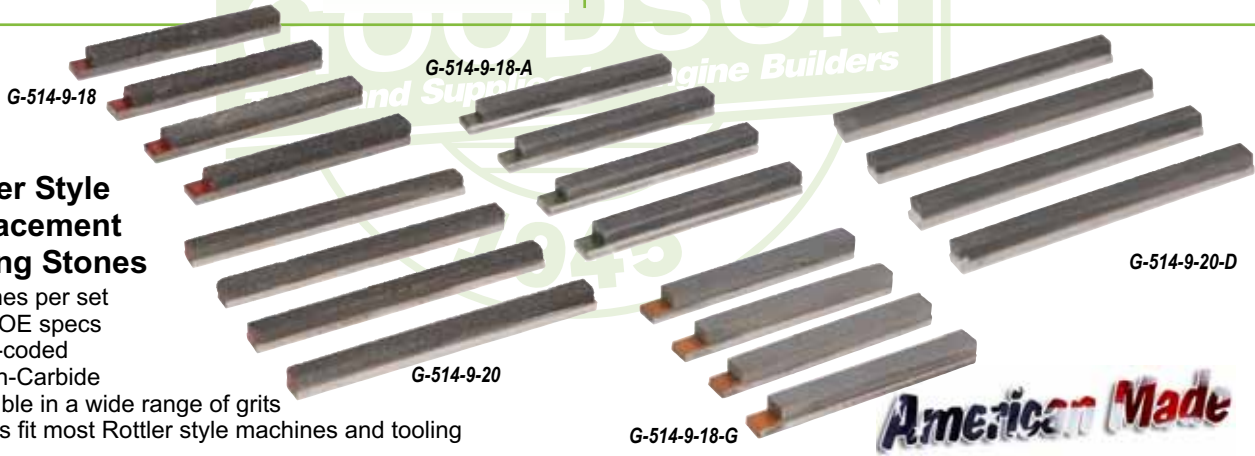

### Rottler Style Replacement Honing Stones

- 4 stones per set
- Meet OE specs
- Color-coded
- Silicon-Carbide
- Available in a wide range of grits
- Stones fit most Rottler style machines and tooling

Grit	Length	Color	Jobber	Order No.
80 Grit	2.75"	Red	\$39.99	<b>G-514-9-18</b>
	4.00"	Red	39.99	<b>G-514-9-20</b>
180 Grit Hard	2.75"	Green	39.99	<b>G-514-9-18-A</b>
	4.00"	Green	39.99	<b>G-514-9-20-A</b>
180 Grit Medium	2.75"	Blue	39.99	<b>G-514-9-18-B</b>
	4.00"	Blue	39.99	<b>G-514-9-20-B</b>
220 Grit	2.75"	Yellow	39.99	<b>G-514-9-18-C</b>
	4.00"	Yellow	39.99	<b>G-514-9-20-C</b>
320 Grit Hard	2.75"	White	39.99	<b>G-514-9-18-D</b>
	4.00"	White	39.99	<b>G-514-9-20-D</b>
320 Grit Medium	2.75"	Brown	39.99	<b>G-514-9-18-H</b>
	4.00"	Brown	39.99	<b>G-514-9-20-G</b>
400 Grit	2.75"	Black	39.99	<b>G-514-9-18-F</b>
	4.00"	Black	39.99	<b>G-514-9-20-E</b>
600 Grit	2.75"	Orange	44.99	<b>G-514-9-18-G</b>
	4.00"	Orange	44.99	<b>G-514-9-20-F</b>

### Rottler Style Replacement Diamond Honing Stones

- Metal bonded
- 3.00" long
- 4 stones per set

Grit	Length	Ra	Jobber	Order No.
170/200	3.00"	45-60	\$499.99	<b>GD-514-9-14-K</b>
325/400	3.00"	24-30	499.99	<b>GD-514-9-14-E</b>
600	3.00"	8-12	499.99	<b>GD-514-9-14-G</b>



## Tire Changer Parts (see pgs. 118-119 for more Mount/Demount Heads)



### Mount/ Demount Head

- For Hunter
- Order No. **TC-14120**  
Jobber \$39.99



### Duck Head Inserts

- For FMC, Hoffman and Corgi
- 10 pieces per pack
- Order No. **TC-24715**  
Jobber \$19.99



### Duck Head Inserts

- For Accu Turn
- 10 pieces per pack
- Order No. **TC-247G15A**  
Jobber \$35.99



### Duck Head Inserts & Rollers

- For AccuTurn
- 4 pieces per set
- Order No. **TC-24016079**  
Jobber \$19.99



### Quilted Sock/Jaw Protectors

- For Coats
- 10 pieces per pack
- Order No. **TC-183604**  
Jobber \$39.99

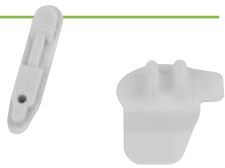

### Duck Head Inserts

- For Hunter Stainless Steel Duck Head
- 10 per package
- Order No. **TC-11400096**  
Jobber \$34.99



### Rim Protectors

- For Coats
- 12 pieces per pack
- Order No. **TC-182963**  
Jobber \$20.99



### Rim Protectors

- For Sicam & AccuTurn
- 5 pieces per pack
- Order No. **TC-101608**  
Jobber \$23.99



### Jaw Covers

- For Sicam
- 4 pieces per pack
- Order No. **TC-141402**  
Jobber \$22.99



### Jaw Protectors

- For AccuTurn, Coats and Corgi
- 4 pieces per set
- Order No. **TC-24720**  
Jobber \$23.99

Visit [www.goodson.com](http://www.goodson.com) for additional information and to see our full listing of tire changer parts



### Head-Bolt Hole Clean-out Taps

- Cleans threaded holes to prevent false torque wrench readings
- Lifts rust, dirt, chips and other debris as you remove the tool
- Use with lube and a socket wrench or slow drill
- Repairs minor damage • New sizes ideal for LS engines

Size	Pitch	Length	Jobber	Order No.
1/2"	13	3 3/8" OAL	\$ 49.99	BCT-1/2
3/4"	14	3 3/8" OAL	49.99	BCT-7/16
10mm	2.0mm	8" Shank	<b>NEW</b> 129.99	BCT-10X2L
11mm	1.5mm	8" Shank	114.99	BCT-11L
11mm	2.0mm	8" Shank	<b>NEW</b> 129.99	BCT-11X2L



### ARMEX® Maintenance XL Formula Soda Blast Cleaning Media

- 270 micron / 70 Grit Formula
- Larger particle for faster cleaning
- Soda crystals are sharp, providing outstanding cleaning / stripping performance, even under relatively low pressure
- Use to strip clean almost any car surface including, steel, aluminum, Fiberglas® and plastics
- Ideal for blocks, heads and intake manifolds
- Dissolves in warm water, minimizing particle ingresson that can block fuel lines and passageways
- Won't damage the surface you're cleaning
- Non-toxic and non-hazardous with a pH of 8.2
- 50 lb. (22.7 kG) bags
- Order No. **SMB-170** Jobber \$34.99

### Decking Jig for V-Twin Heads

- Use this jig to mount V-Twin heads on your mill
- Fast and accurate
- Solid steel construction
- Includes Socket Head Cap Mounting Screws
- Measures 3" x 5 1/2" x 1 1/4"
- Order No. **HDF-113**  
Jobber \$99.99



# new and improved

Protective rubber boot keeps the mechanism debris-free

Platform handles springs up to 2.0" diameter and 4.50" OAL

Easy-to-Read 5" diameter Ashcroft-quality analog pressure gauge

Base incorporates four 5/16" holes for mounting the Valve Spring Tester to your bench

New vertical scale shows inches on one side and millimeters on the other

Ergonomically designed T-Handle grip conforms to the operator's hand for firm control

Over-center cam action holds springs at desired height for repeatable accuracy

Locking knob on pressing anvil allows for up to 1" of fine height adjustment

Powder coated texture finish protects the unit from rust and fingerprints

New pressure gauge reads in both pounds and kilograms

**American Made**

## GOODSON 600 Pound Analog Valve Spring Tester

- 5" diameter Ashcroft quality analog pressure gauge with 600 lb. (272kG) capacity in 10 lb. (4.54kG) increments
- Platform handles springs up to 2" diameter x 4 1/2" OAL
- Vertical height adjustments in 3/4" increments
- Adjustable pressing anvil for fine-tuning open and closed pressures for height measurement
- T-Handle conforms to the operator's grip for firm control
- Rubber protective boot keeps the mechanism debris-free
- Over-center cam action holds spring at the desired height
- Calibrated and Sealed hydraulic load cell
- Integral vertical height scale that moves 180° left to right
- Base features four 5/16" mounting holes to bolt it to the bench
- Order No. **VST-60G** Jobber \$879.99



Integral Height Scale rotates 180° left to right. Scale shows inches on one side and millimeters on the other.



5 pre-drilled height adjustment holes on the rear spaced 3/4" apart.



Measures a full 28" tall with the handle fully extended.

CYLINDER HEAD REBUILDING  
CLEANING, ASSEMBLY & SAFETY  
SHORT BLOCK REBUILDING  
CRANKSHAFT/ FLYWHEEL GRINDING  
MISCELLANEOUS TOOLS & SUPPLIES  
BRAKE & TIRE CHANGING TOOLS  
MEASURING TOOLS  
V-TWIN & METRIC HARD PARTS

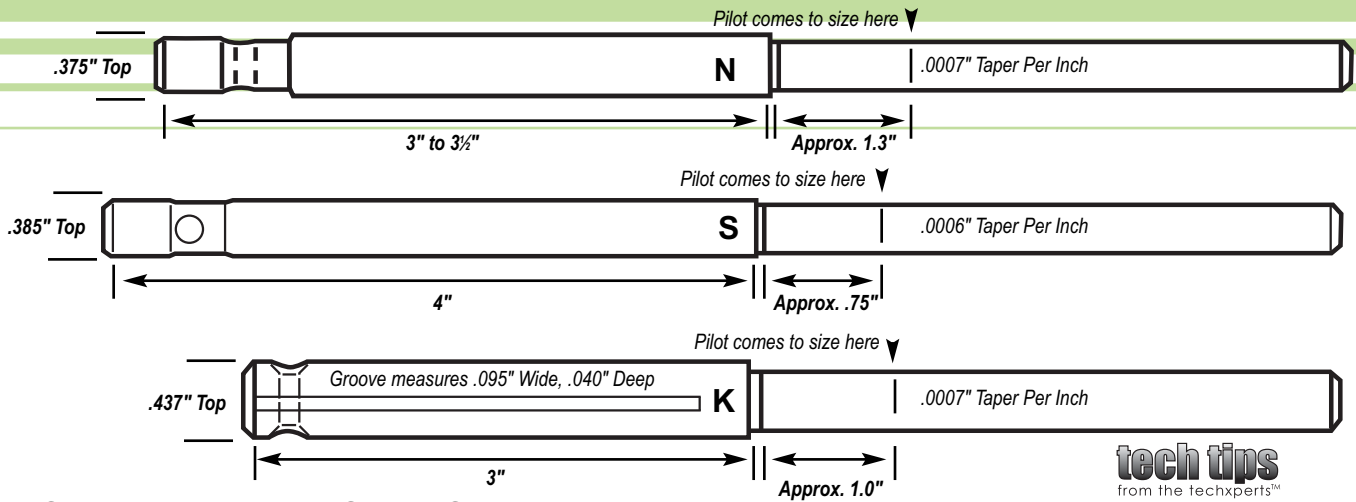

**tech tips**  
from the techxperts™

## Solid-Tapered High Speed Steel Pilots

• Fit all popular seat grinding or seat and guide machines • Working range of .001"

## Selecting your pilot

1. Determine the Guide ID or Valve Stem Diameter plus oil clearance.
2. Select Top Size: .236", .297", .375", .385" or .437" based on your tooling.
3. Select the Pilot Type: Tapered, Expanding, Straight (Live) or Extra-Long.
4. Select Pilot Material: High Speed Steel or Carbide.
5. Find the Pilot(s) in the charts on the next three pages and call **1-800-533-8010** to order or order online at [www.goodson.com](http://www.goodson.com).

Pilot Size		Order Numbers for Top Sizes		
Inch	mm	.375"	.385"	.437"
.1560"	3.96	—	P-5156S	—
.1570"	3.98	—	P-5157S	—
.1574"	4.00	—	P-5158S	—
.1771"	4.50	P-5177N	P-5177S	P-5177K
.1960"	4.98	P-5196N	P-5196S	P-5196K
.1968"	5.00	P-5197N	P-5197S	P-5197K
.1976"	5.02	P-5198N	P-5198S	P-5198K
.2165"	5.50	P-5216N	P-5216S	P-5216K
.2173"	5.52	P-5217N	P-5217S	P-5217K
.2185"	5.55	P-5218N	P-5218S	P-5218K
.2354"	5.98	P-5235N	P-5235S	P-5235K
.2362"	6.00	P-5236N	P-5236S	P-5236K
.2370"	6.02	P-5237N	P-5237S	P-5237K
.2381"	6.05	P-5238N	P-5238S	P-5238K
.2397"	6.08	P-5239N	P-5239S	—
.2490"	6.32	P-5249N	—	P-5249K
.2500"	6.35	P-5250N	P-5250S	P-5250K
.2510"	6.37	P-5251N	P-5251S	P-5251K
.2559"	6.50	P-5256N	—	—
.2566"	6.52	P-5257N	—	—
.2580"	6.55	P-5258N	P-5258S	P-5258K
.2590"	6.58	—	P-5259S	P-5259K
.2598"	6.60	P-5260N	P-5260S	P-5260K
.2610"	6.62	—	P-5261S	P-5261K
.2620"	6.65	—	P-5262S	—
.2748"	6.98	P-5274N	P-5274S	—
.2755"	7.00	P-5275N	P-5275S	P-5275K
.2760"	7.01	—	P-5276S	P-5276K
.2763"	7.02	P-5277N	P-5277S	P-5277K
.2775"	7.05	P-5278N	P-5278S	P-5278K
.2792"	7.09	P-5279N	P-5279S	P-5279K
.2952"	7.50	P-5295N	—	—
.2960"	7.52	P-5296N	—	—
.3095"	7.86	P-5309N	—	—
Jobber		\$35.99	\$47.99	\$57.99

Pilot Size		Order Numbers for Top Sizes		
Inch	mm	.375"	.385"	.437"
.3105"	7.88	P-5310N	P-5310S	P-5310K
.3115"	7.91	P-5311N	P-5311S	P-5311K
.3125"	7.93	P-5312N	P-5312S	P-5312K
.3135"	7.96	P-5313N	P-5313S	P-5313K
.3145"	7.98	P-5314N	P-5314S	P-5314K
.3149"	8.00	P-5315N	P-5315S	P-5315K
.3165"	8.03	P-5316N	P-5316S	P-5316K
.3175"	8.06	—	P-5317S	P-5317K
.3185"	8.08	—	P-5318S	P-5318K
.3397"	8.62	P-5339N	—	—
.3407"	8.65	P-5340N	P-5340S	—
.3417"	8.67	P-5341N	P-5341S	P-5341K
.3427"	8.70	P-5342N	P-5342S	P-5342K
.3437"	8.72	P-5343N	P-5343S	P-5343K
.3447"	8.75	P-5344N	P-5344S	P-5344K
.3457"	8.78	P-5345N	P-5345S	P-5345K
.3543"	9.00	P-5354N	P-5354S	P-5354K
.3550"	9.01	P-5355N	P-5355S	P-5355K
.3560"	9.04	—	P-5356S	—
.3587"	9.11	P-5358N	P-5358S	P-5358K
.3730"	9.47	P-5373N	P-5373S	P-5373K
.3740"	9.49	P-5374N	P-5374S	P-5374K
.3750"	9.52	P-5375N	P-5375S	P-5375K
.3760"	9.55	P-5376N	P-5376S	—
.3771"	9.58	P-5377N	—	—
.3780"	9.60	P-5378N	P-5378S	—
.3790"	9.62	P-5379N	P-5379S	P-5379K
.3820"	9.70	P-5382N	P-5382S	—
.3930"	9.98	—	P-5393S	—
.3937"	10.00	P-5394N	P-5394S	P-5394K
.4330"	11.00	P-5433N	P-5433S	—
.4365"	11.08	P-5436N	—	—
.4375"	11.11	P-5437N	—	—
.4385"	11.13	P-5438N	—	—
.4395"	11.16	P-5439N	—	—
Jobber		\$35.99	\$47.99	\$57.99

## .297" Top Solid-Tapered High Speed Steel Pilots

- Working range of .001"
- Use with Neway Small Series Cutter Bodies on page 12

Pilot Size		
Inch	mm	Order No.
.1490"	3.78	P-1149N
.1574"	4.00	P-1158N
.1582"	4.02	P-1159N
.1771"	4.50	P-1177N
.1779"	4.52	P-1178N
.1968"	5.00	P-1197N
.1976"	5.02	P-1198N
.2165"	5.50	P-1216N
.2173"	5.52	P-1217N
.2362"	6.00	P-1236N
.2370"	6.02	P-1237N
.2381"	6.05	P-1238N
.2490"	6.32	P-1249N
.2500"	6.35	P-1250N
.2510"	6.37	P-1251N
.2598"	6.60	P-1260N
.2755"	7.00	P-1275N
.3125"	7.93	P-1312N
.3135"	7.96	P-1313N
.3149"	8.00	P-1315N
.3437"	8.72	P-1343N
Jobber		\$21.99

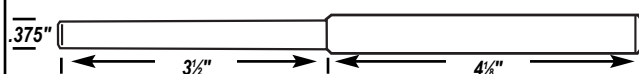

## Large Diameter Solid-Tapered High Speed Steel Pilots

• Working range of .001"

Pilot		Order Numbers for Top Sizes	
Inch	mm	.375"	.385"
.5000"	12.70	P-5500N	P-5500S
.5010"	12.72	P-5501N	P-5501S
.5020"	12.75	P-5502N	P-5502S
Jobber		\$79.99	\$79.99

## How to set your expanding pilot

- 1 Select an expanding pilot that is the same diameter as the valve guide ID
- 2 Insert the pilot into the valve guide making sure that the expanding section of the pilot (collet) is completely within the valve guide. The pilot will not center properly and may be damaged if the collet extends outside of the valve guide.
- 3 Pilot shoulder should be about 1/8" above the valve guide
- 4 Turn the pilot while holding the nut at the opposite end. This will expand the collet and secure the pilot into position

**NOTE: DO NOT** use Expanding Pilots with multi-angle valve seat cutting systems (ie: 3-D Fast Cut)

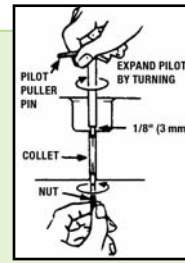

Pilot Top Length  
NX = 2-3"  
NXL = 3 1/2"  
SX = 4"

.....→ shoulder  
.....→ collet  
.....→ expander  
.....→ adjusting nut

## .020" / .51mm Range High Speed Steel Expanding Pilots

- Comes with everything you need, including the Collet and Expander • High Speed Steel
- NOT for use with multi-angle seat cutting tooling such as Goodson 3-D Fast Cut

Size	mm	Range	PILOT TOP SIZE			Replacement	
			.375" / Std.	.385" / Std.	.437" / Std.	Collets	Expanders
.216"	5.5	.213"-.233"	P-5.5MMNX	—————	—————	P-216-COLLET	P-216-EXP
.236"	6.0	.233"-.253"	P-6MMNX	P-6MMSX	P-6MMKX	P-6MM-COLLET	P-6MM-EXP
.250"	6.3	.247"-.267"	P-250NX	P-250SX	—————	P-250-COLLET	P-250-EXP
.256"	6.5	.253"-.273"	P-6.5MMNX	P-6.5MMSX	—————	P-65MM-COLLET	P-6.5MM-EXP
.275"	7.0	.272"-.292"	P-7MMNX	P-7MMSX	P-7MMKX	P-7MM-COLLET	P-7MM-EXP
.281"	7.1	.278"-.298"	—————	P-281SX	—————	P-281-COLLET	P-281-EXP
.295"	7.5	.290"-.310"	—————	P-7.5MMSX	—————	P-281-COLLET	P-281-EXP
.312"	7.9	.309"-.329"	P-312NX	P-312SX	P-312KX	P-312-COLLET	P-343-EXP
.335"	8.5	.330"-.350"	P-8.5MMNX	P-8.5MMSX	—————	P-343-COLLET	P-343-EXP
.343"	8.7	.340"-.360"	P-343NX	P-343SX	P-343KX	P-343-COLLET	P-343-EXP
.354"	9.0	.350"-.370"	P-9MMNX	P-9MMSX	—————	P-375-COLLET	P-375-EXP
.375"	9.5	.372"-.392"	P-375NX	P-375SX	P-375KX	P-375-COLLET	P-375-EXP
.393"	10.0	.390"-.410"	P-10MMNX	P-10MMSX	—————	P-10MM-COLLET	P-10MM-EXP
.406"	10.3	.403"-.433"	—————	P-406SX	—————	P-10MM-COLLET	P-10MM-EXP
.437"	11.0	.430"-.450"	P-11MMNX	P-11MMSX	P-11MMKX	P-11MM-COLLET	P-11MM-EXP
.453"	11.5	.450"-.470"	P-453NX	P-453SX	P-453KX	P-11MM-COLLET	P-11MM-EXP
.472"	12.0	.469"-.489"	P-12MMNX	P-12MMSX	—————	P-12MM-COLLET	P-12MM-EXP
.500"	12.7	.497"-.517"	—————	P-500SX	—————	P-12MM-COLLET	P-12MM-EXP
Jobber			\$49.99	\$81.99	\$59.99	\$17.99	\$9.99

When choosing a pilot, first decide if you need a "live" pilot (one which turns with the tooling) or "dead" pilot (one which remains stationary in the bore). Choose the top size, then the guide bore size.

## Tapered Carbide Pilots

- Less deflection under stress • Due to the brittle nature of carbide we can only warranty carbide pilots for size.

Inch	mm	.236" Top	.375" Top	Inch	mm	.236" Top	.375" Top
.1559"	3.96	PCT-1560M	—————	.2370"	6.02	PCT-2370M	PCT-2370
.1566"	3.98	PCT-1570M	—————	.2559"	6.50	PCT-2560M	—————
.1575"	4.00	PCT-1575M	PCT-1575	.2570"	6.53	PCT-2570M	—————
.1579"	4.01	PCT-1580M	—————	.2578"	6.55	PCT-2580M	—————
.1759"	4.47	PCT-1760M	—————	.2590"	6.58	PCT-2590M	—————
.1771"	4.50	PCT-1770M	PCT-1770	.2598"	6.60	PCT-2600M	PCT-2600
.1779"	4.52	PCT-1780M	—————	.2756"	7.00	PCT-2756M	PCT-2756
.1960"	4.98	PCT-1960M	—————	.2759"	7.01	PCT-2760M	PCT-2760
.1968"	5.00	PCT-1970M	PCT-1970	.2763"	7.02	PCT-2765M	PCT-2765
.1980"	5.03	PCT-1980M	—————	.2771"	7.04	PCT-2770M	PCT-2770
.2161"	5.49	PCT-2160M	—————	.3122"	7.93	—————	PCT-3120
.2165"	5.50	—————	PCT-2165	.3149"	8.00	—————	PCT-3150
.2173"	5.52	PCT-2170M	PCT-2170	.3425"	8.70	—————	PCT-3420
.2181"	5.54	PCT-2180M	—————	.3433"	8.72	—————	PCT-3430
.2350"	5.97	PCT-2350M	—————	.3440"	8.74	—————	PCT-3440
.2355"	5.98	—————	PCT-2355	.3728"	9.47	—————	PCT-3730
.2358"	5.99	PCT-2360M	—————	.3740"	9.50	—————	PCT-3740
.2362"	6.00	—————	PCT-2362	.3752"	9.53	—————	PCT-3750
Jobber		\$179.99	\$179.99	Jobber		\$179.99	\$179.99

## .375" Top Serdi-Style (Live) Straight Carbide Pilots

- For applications where the pilot must turn with the tooling
- Solid carbide construction
- Due to the brittle nature of carbide, Goodson can only warranty these carbide pilots for size

mm	in	Order No.	mm	in	Order No.	mm	in	Order No.
3.99	.1571"	PCS-399	6.50	.2559"	PCS-650	8.00	.3150"	PCS-800
4.00	.1575"	PCS-400	6.59	.2594"	PCS-659	8.01	.3154"	PCS-801
4.01	.1579"	PCS-401	6.61	.2600"	PCS-661	8.02	.3157"	PCS-802
4.49	.1767"	PCS-449	6.99	.2752"	PCS-699	8.70	.3425"	PCS-870
4.50	.1771"	PCS-450	7.00	.2756"	PCS-700	8.72	.3433"	PCS-872
4.98	.1960"	PCS-498	7.01	.2760"	PCS-701	8.73	.3437"	PCS-873
4.99	.1964"	PCS-499	7.02	.2764"	PCS-702	8.74	.3440"	PCS-874
5.00	.1968"	PCS-500	7.03	.2768"	PCS-703	9.45	.3720"	PCS-945
5.48	.2157"	PCS-548	7.04	.2771"	PCS-704	9.46	.3724"	PCS-946
5.49	.2161"	PCS-549	7.90	.3110"	PCS-790	9.47	.3728"	PCS-947
5.50	.2165"	PCS-550	7.91	.3114"	PCS-791	9.48	.3732"	PCS-948
5.98	.2354"	PCS-598	7.92	.3118"	PCS-792	9.49	.3736"	PCS-949
5.99	.2358"	PCS-599	7.93	.3122"	PCS-793	9.51	.3744"	PCS-951
6.00	.2362"	PCS-600	7.95	.3130"	PCS-795	9.52	.3748"	PCS-952
6.01	.2368"	PCS-601	7.99	.3146"	PCS-799	Jobber		\$179.99
Jobber		\$179.99	Jobber		\$179.99			

CYLINDER HEAD REBUILDING  
CLEANING, ASSEMBLY & SAFETY  
SHORT BLOCK REBUILDING  
CRANKSHAFT/ FLYWHEEL GRINDING  
MISCELLANEOUS TOOL SUPPLIES  
BRAKE & TIRE CHANGING TOOLS  
MEASURING TOOLS  
V-TWIN & METRIC HARD PARTS

Groove accommodates bearing-style stone holders



See preceding page for how to set expanding pilots

### .297" Top Expanding Pilots

- Expand up to .020" (.51mm) • Comes with Collet & Expander • High Speed Steel

Size	mm	Range	Pilot	Collet	Expander
.2165"	5.50	.213"-.233"	P-1216NX	P-216-COLLET	P-1216-EXP
.2362"	6.00	.233"-.253"	P-1236NX	P-6MM-COLLET	P-1236-EXP
.2500"	6.35	.247"-.267"	P-1250NX	P-250-COLLET	P-1250-EXP
.2810"	7.14	.278"-.298"	P-1281NX	P-281-COLLET	P-1281-EXP
.3120"	7.92	.309"-.329"	P-1312NX	P-312-COLLET	P-1312-EXP
.3149"	8.00	.312"-.332"	P-1315NX	P-312-COLLET	P-1315-EXP
	Jobber		\$47.99	\$17.99	\$9.99

### .375" Extended Length Expanding Pilots

- Expand up to .020" (.51mm) • Comes with Collet & Expander • High Speed Steel

Size	mm	Range	Pilot	Collet	Expander
.3120"	7.92	.309"-.329"	P-312NXL	P-312L-COL	P-343-EXP
.3430"	8.71	.340"-.360"	P-343NXL	P-343L-COL	P-343-EXP
.3750"	9.52	.372"-.392"	P-375NXL	P-375L-COL	P-375-EXP
.4060"	10.31	.403"-.433"	P-406NXL	P-406L-COL	P-10MM-EXP
.4527"	11.50	.451"-.455"	P-453NXL	P-453L-COL	P-453-EXP
.4724"	12.00	.471"-.475"	P-12MMNXL	P-12MML-COL	P-12MM-EXP
.5000"	12.70	.497"-.517"	P-500NXL	P-500L-COL	P-12MM-EXP
	Jobber		\$54.99	\$17.99	\$9.99



### .375" Top Leveling Split Pilots

- Centers deep in the valve guide
- Includes a groove for bearing-style stone holders
- Compensates for wear up to .010" • Replace KO Lee
- 3" long top (nominal)

Size	Range	Jobber	Order No.
5.0mm	.193"-.203"	\$179.99	P-5MM-VNX
5.5mm	.213"-.223"	174.99	P-5.5MM-VNX
6.0mm	.233"-.243"	164.99	P-6MM-VNX
.250"	.247"-.257"	149.99	P-250-VNX
7.0mm	.273"-.283"	164.99	P-7MM-VNX
.312"	.299"-.319"	139.99	P-312-VNX
8.0mm	.312"-.322"	154.99	P-8MM-VNX
.343"	.340"-.350"	147.99	P-343-VNX
9mm	.351"-.361"	154.99	P-9MM-VNX
.375"	.372"-.382"	147.99	P-375-VNX
.437"	.434"-.444"	147.99	P-437-VNX



### .572" Top Pilots For large diameter SX-1703 or OE Sioux™ 1703 Holders

Inch	mm	Order No.	Inch	mm	Order No.
.5618"	14.27	P-5562S	.6259"	15.90	P-5626S
.5629"	14.30	P-5563S	.6267"	15.92	P-5627S
.5641"	14.33	P-5564S	.6279"	15.95	P-5628S
.6252"	15.88	P-5625S			
Jobber		\$157.99	Jobber		\$157.99

See page 18 for Stone Holder

## tech tips

from the techxperts™

We get asked from time to time why Goodson carries so many sizes and styles of pilots.

The short answer is, "They're needed."

To expand on that ... The pilot is possibly the most important tool you can have. Without the right size pilot, you won't be able to do accurate work.

Most of us probably think of that in terms of Top and Bottom Size, but there's another dimension that's becoming more important every day. The pilot's top length.

You've probably worked on (or at least seen) heads with deeply set valves. This is especially common in diesel applications. Some of them are set so deeply that a standard pilot just won't cut it. You need a pilot that extends above the deck while still being fully seated in the guide in order to perform top quality seat work.

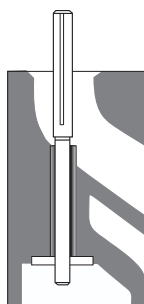

Left: The standard length pilot protrudes beyond the head surface very slightly.

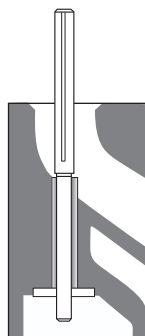

Right: The extended length pilot protrudes further from the head giving your tooling more support for cutting or grinding

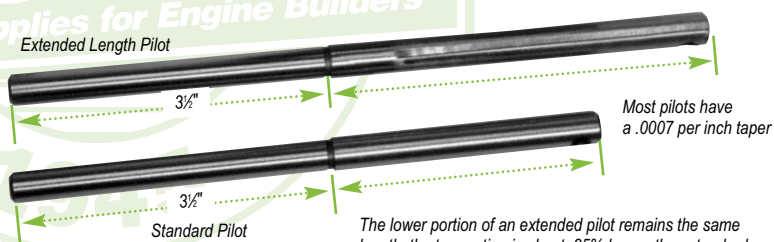

### Extended Length Top Solid-Tapered High Speed Steel Pilots

Inch	mm	.375" Top	.385" Top	Inch	mm	.375" Top	.385" Top
.2169"	5.51	P-5217NL	—	.3141"	7.98	P-5314NL	P-5314SL
.2181"	5.54	P-5218NL	—	.3149"	8.00	P-5315NL	—
.2362"	6.00	P-5236NL	—	.3161"	8.03	P-5316NL	—
.2370"	6.02	P-5237NL	—	.3409"	8.66	P-5341NL	—
.2607"	6.60	P-5260NL	—	.3421"	8.69	P-5342NL	—
.2610"	6.63	P-5261NL	—	.3429"	8.71	P-5343NL	P-5343SL
.2748"	6.98	P-5275NL	P-5275SL	.3440"	8.74	P-5344NL	P-5344SL
.2756"	7.00	P-5276NL	P-5276SL	.3452"	8.77	P-5345NL	P-5345SL
.2772"	7.04	—	P-5277SL	.3460"	8.79	—	P-5346SL
.2779"	7.06	—	P-5278SL	.3716"	9.44	—	P-5372SL
.2787"	7.08	—	P-5279SL	.3728"	9.47	P-5373NL	P-5373SL
.3098"	7.87	P-5310NL	—	.3740"	9.50	P-5374NL	P-5374SL
.3110"	7.90	P-5311NL	—	.3751"	9.53	P-5375NL	P-5375SL
.3118"	7.92	P-5312NL	P-5312SL	.3759"	9.55	P-5376NL	—
.3129"	7.95	P-5313NL	P-5313SL	.3819"	9.70	P-5382NL	—
Jobber		\$57.99	\$89.99	Jobber		\$57.99	\$89.99

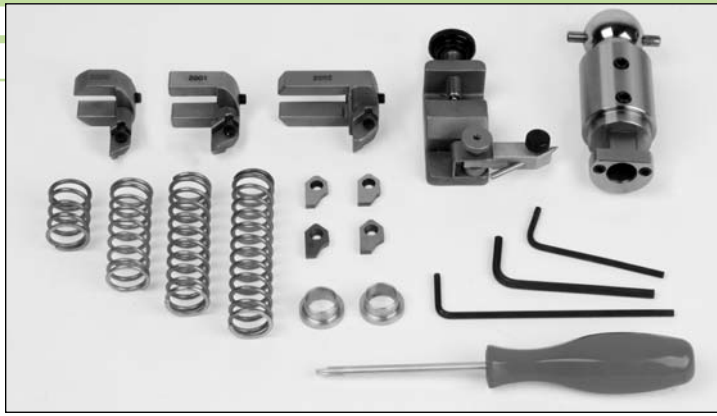

Ball Heads

### 3-D Fast Cut™ Starter Kits

- Can be used with your existing pilots • Ball heads are available to fit most common seat grinder pilots • Choose from over 100 3-angle blade profiles on pages 6-9
- Fully compatible with most popular 3-angle cutting systems including Kwik-Way, Peterson, Rottler, Serdi, Sunnen, T&S, Winona Van Norman, Newen, etc.

Description	Fits Pilot	Jobber	Order No.	Includes			
<b>Fits Pilot Size</b>	.375" / 9.53mm	\$859.99	3D-375-KIT				
(see page 1 for our selection of pilots)	.385" / 9.78mm	859.99	3D-385-KIT				
	.390" / 9.90mm	859.99	3D-390-KIT				
	.437" / 11.10mm	859.99	3D-437-KIT				
<b>Ball Head Standard</b>	.375" / 9.53mm	219.99	3D-BH375		x		
3/8" channel fits most	.385" / 9.78mm	219.99	3D-BH385		x		
3-angle systems such as Serdi, WVN, KW, etc.	.390" / 9.90mm	219.99	3D-BH390		x		
	.437" / 11.10mm	219.99	3D-BH437	x			
<b>Ball Head Extended</b>	.375" / 9.53mm	249.99	3D-BH375L				
<b>Length 3.80" long</b>	.385" / 9.78mm	249.99	3D-BH385L				
<b>Ball Head Wide Body</b>	.375" / 9.53mm	349.99	3D-BH375W				
<b>4.0625" long</b>	.385" / 9.78mm	349.99	3D-BH385W				
<b>Serdi-Style Tool Bodies</b>	Use with Serdi-style pilots (page 2)						
<b>4" long</b>	Standard .375" / 9.53mm	299.99	SER-5100				
	Large Body .375" / 9.53mm	369.99	SER-5300				
<b>Tip Holders</b>	.709" - 1.181" / 18-30mm Range	164.99	3D-2000	x	x	x	x
	1.02" - 1.653" / 26-42mm Range	164.99	3D-2001	x	x	x	x
	1.575" - 2.362" / 40-60mm Range	164.99	3D-2002	x	x	x	x
<b>Tip Holders-Wide Body</b>	1.575" - 2.362" / 40-60mm Range	239.99	3D-2003				
	2.385" - 3.150" / 58-80mm Range	239.99	3D-2004				
<b>Cutters</b>	45°/1.0mm	29.99	FT-45039V1	x	x	x	x
	45°/1.3mm	29.99	FT-45051V1	x	x	x	x
more on pages 6 - 9	45°/1.5mm	29.99	FT-45059V1	x	x	x	x
	45°/1.9mm	29.99	FT-45075V1	x	x	x	x
<b>Tool Setting Fixture</b>		139.99	3D-TSFA	x	x	x	x
<b>Cutter Blade Mounting Screw</b> (Buy 6 or more, only \$3.99 ea.)		4.99	FT-SCREW	x	x	x	x
<b>Blade Wrench</b>		8.99	FT-WRENCH	x	x	x	x
<b>Automotive Spring Set (4 Pc.)</b>		24.99	3D-SS4	x	x	x	x
<b>Bushing Set (1 pair)</b>	.375"	8.99	3D-DB7				x
	.385"	8.99	3D-DB6		x	x	
	.437"	8.99	3D-DB5	x			
<b>Ball Head</b>	#3 Morse Taper Driver	334.79	3D-CM3				
<b>Drive Adaptors</b>	#4 Morse Taper Driver	334.79	3D-CM4				
	Bridgeport & DCM Driver	284.99	3D-3/4SS				
	Sunnen Early Style Driver	304.99	3D-SUN				
<b>3-D Fast Cut™ Accessories</b>							
<b>Lift Clip for Spring Pad Cutters</b> (page 10)		\$21.99	3D-CLIP				
<b>Replacement 1/8" Hex Key</b>		1.29	3D-1/8	x	x	x	x
<b>Replacement 2.5mm Hex Key</b>		1.29	3D-2.5	x	x	x	x
<b>Replacement 1/2" Hex Key</b>		1.29	3D-3/32	x	x	x	x
<b>Replacement Screws for NWN Ball Head Base (5) - metric</b>		1.99	MGA-4X5MM				
<b>Replacement Screw for 3D Ball Head Base - SAE 10x32</b>		4.99	3D-BH1032				
<b>Adjusting Screw for Holder #3D-2000, OAL: .395" / 10mm</b>		5.29	3D-2000-S				
<b>Adjusting Screw for Holder #3D-2001, OAL: .475" / 12mm</b>		5.29	3D-2001-S				
<b>Adjusting Screw for Holder #3D-2002, OAL: .625" / 15.9mm</b>		5.29	3D-2002-S				

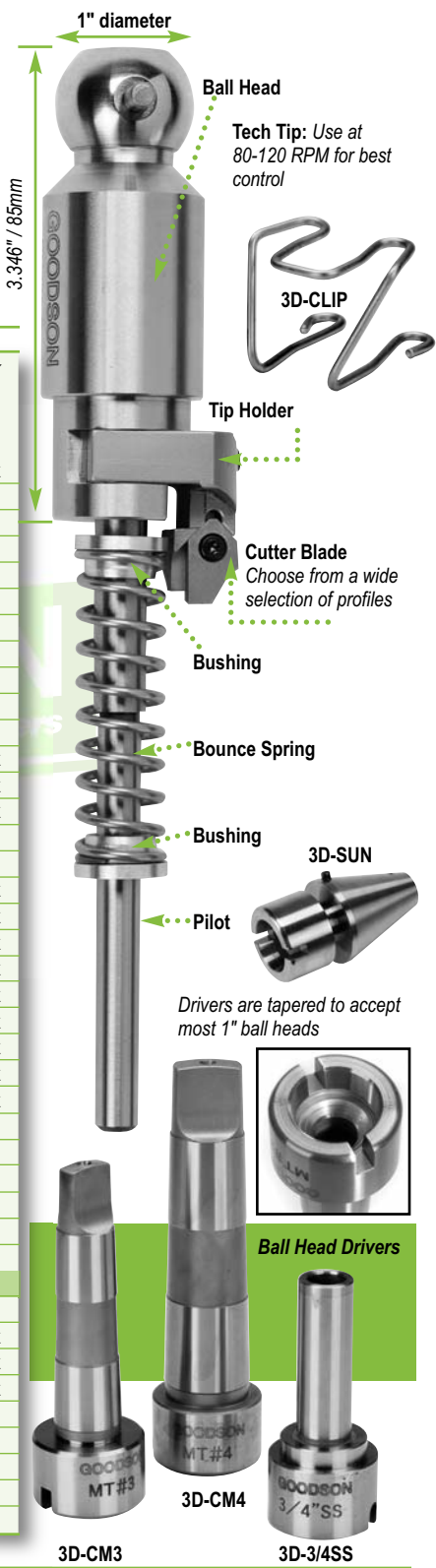

See page 5 for our Valve Seat Removal Tooling for the 3-D Fast Cut™ System

## tech tips Choosing the Ball Head Driver

from the techxperts™ Choose the correct Ball Head Driver for your machine by finding your pilot size in the charts on pages 4 & 5 (Example if you have .375" top pilots you will use the 3D-BH375; if your pilot size is .236", you will use 3D-BH236, etc.). Goodson 3-D tooling is available in kits, incorporating all of the necessary pieces. You can also purchase items on an individual basis. Goodson carries many accessories and optional equipment for you to choose from.

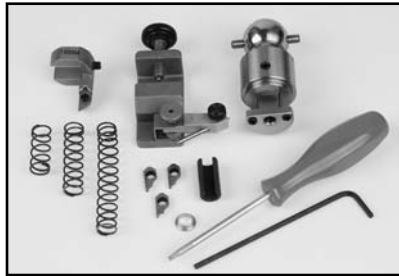

Holders have been modified to provide support to cutters without interfering with the bowl diameter.

Micro Cutter Tips FTM-190 and FTM-82R6B-HP only fit Tip Holder 3DH-1995

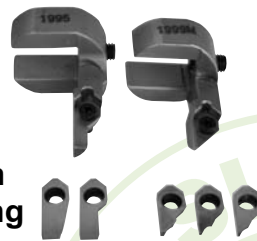

### 3-D Fast Cut™ System Micro Ball Head Tooling

• Fits the same 1" ball head driver

Description	Jobber	Order No.
<b>Micro Ball Head Starter Kit</b>	\$659.99	3D-236-KIT
<b>3D Ball Head for .236"/6mm Pilot (2.56"L)</b>	199.99	3D-BH236
<b>Micro Cutter Tips</b> 45°/1.0mm	39.99	FTM-185
See pg. 7 45°/1.0mm	39.99	FTM-187
for profiles 39°/1.0mm	39.99	FTM-188
90° (For counterboring*)	39.99	FTM-190
82° Radius Cutter	39.99	FTM-82R6B-HP
<b>Tip Holders</b> .550"-.984" Range	179.99	3DH-1999M
.551"-.850" Range	179.99	3DH-1995
<b>Bounce Springs</b> Short 1.050" / 26.7mm	11.79	3D-BS1
.340" ID Medium 1.540" / 39.2 mm	11.79	3D-BS3
.420" OD Long 2.550" / 64.8 mm	11.79	3D-BS2
<b>Bounce Spring Bushing</b>	7.99	3D-BB1
<b>Bounce Spring Spacer, 22mm long</b>	29.99	3D-BB2

#### 3-D Fast Cut™ Accessories

Replacement 2.5mm Hex Key	\$1.29	3D-2.5
Replacement Screws for Ball Head	4.99	3D-BH1032
Cutter Blade Mounting Screw (6 or more, \$3.99 ea.)	4.99	FT-SCREW
Blade Wrench	8.99	FT-WRENCH
Tool Setting Fixture	139.99	3D-TSFA
Setting Micrometer for Counterbore Cutting*	209.99	3DM-236

#### .236" Top Carbide Pilots

Inch	mm	Order No.	Inch	mm	Order No.
.1559"	3.96	PCT-1560M	.2350"	5.97	PCT-2350M
.1566"	3.98	PCT-1570M	.2355"	5.99	PCT-2360M
.1575"	4.00	PCT-1575M	.2370"	6.02	PCT-2370M
.1579"	4.01	PCT-1580M	.2559"	6.50	PCT-2560M
.1759"	4.47	PCT-1760M	.2570"	6.53	PCT-2570M
.1771"	4.50	PCT-1770M	.2578"	6.55	PCT-2580M
.1779"	4.52	PCT-1780M	.2590"	6.58	PCT-2590M
.1960"	4.98	PCT-1960M	.2598"	6.60	PCT-2600M
.1968"	5.00	PCT-1970M	.2756"	7.00	PCT-2756M
.1980"	5.03	PCT-1980M	.2759"	7.01	PCT-2760M
.2161"	5.49	PCT-2160M	.2763"	7.02	PCT-2765M
.2173"	5.52	PCT-2170M	.2771"	7.04	PCT-2770M
.2181"	5.54	PCT-2180M			

Jobber \$179.99

Jobber \$179.99

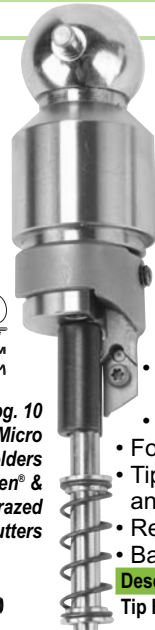

3-D FAST CUT™ SYSTEM

Refer to pg. 10 for more Micro Blade Holders for Sunner® & Mira® brazed cutters

3-D FAST CUT™ SYSTEM

### Valve Seat Removal Tooling

- Fits most popular 3-angle cutting tools including our popular 3-D Fast Cut™ System, Kwik-Way, Peterson, Rottler, Serdi, T&S, Winona Van Norman, Newen, etc.
- Use to relieve press fit for easier seat removal
- Requires a minimum of 2 cuts
- For precise set up use **MGA-MIC**
- Tip Holders include one cutting tip and mounting screw (see chart)
- Replacement tips and screws sold separately
- Ball Head and Drive Tools sold separately (see page 4)

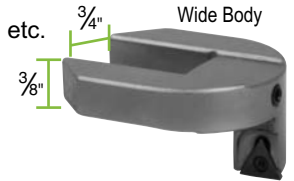
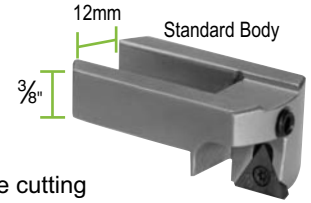

Description	Replacement Tip	Jobber	Order No.
<b>Tip Holders</b>	3DB-1999i	\$224.99	3D-1999C
	3DB-250	219.99	3D-2000C
	3DB-250	219.99	3D-2001C
	3DB-250	224.99	3D-2002C
<b>Wide Body Tip Holders</b>	3DB-250	299.99	3D-2003C
	3DB-250	319.99	3D-2004C
<b>Replacement Tip</b>		34.29	3DB-1999i
		34.29	3DB-250
<b>Replacement Screw</b>	for 3DB-1999i	11.79	3DB-1999S
	for 3DB-250	11.79	3DS-SCREW

#### Cutting Range with Pilot Size

Holder	.236" Top	.375" Top	.385" Top	.437" Top
3D-1999C	0.960"-1.225"	1.095"-1.360"	1.105"-1.360"	1.157"-1.360"
3D-2000C	1.056"-1.480"	1.194"-1.480"	1.206"-1.480"	1.264"-1.480"
3D-2001C		1.376"-2.000"	1.386"-2.000"	1.450"-2.000"
3D-2002C		1.524"-2.460"	1.544"-2.460"	1.610"-2.460"
3D-2003C		1.680"-2.400"	1.680"-2.400"	
3D-2004C		2.280"-3.200"	2.280"-3.200"	

### 3-D Fast Cut Setting Micrometers

- Accurate to .001"
- Standard micrometer uses tapered .375" Pilot to match your ball head (sold separately, page 1)
- Use to set cutting diameter of 90° carbide cutters when modifying counterbores

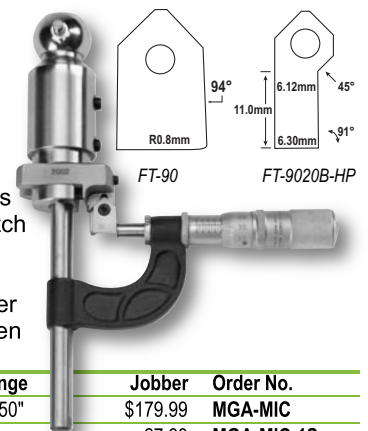

Description	Cutting Range	Jobber	Order No.
Standard Micrometer	1.000" - 2.650"	\$179.99	MGA-MIC
Setting Standard		27.99	MGA-MIC-1S
90° Cutter		29.99	FT-90
90° Cutter		39.99	FT-9020B-HP

### Micro Setting Micrometer

- Use with .236" Pilot (PCT-2360M)

Description	Cutting Range	Jobber	Order No.
Micro Micrometer	0.236" - 2.000"	\$209.99	3DM-236
90° Micro Cutter		39.99	FTM-190
Pilot		179.99	PCT-2360M

CYLINDER HEAD REBUILDING

CLEANING, ASSEMBLY & SAFETY SHORT BLOCK REBUILDING

FLYWHEEL GRINDING CRANKSHAFT/ FLYWHEEL GRINDING

MISCELLANEOUS TOOLS & SUPPLIES

BRAKE & TIRE CHANGING TOOLS

MEASURING TOOLS

V-TWIN & METRIC HARD PARTS

# Mondello Signature Series Cutter Blades

CYLINDER HEAD  
REBUILDING

CLEANING,  
ASSEMBLY & SAFETY

SHORT BLOCK  
REBUILDING

CRANKSHAFT/  
FLYWHEEL GRINDING

MISCELLANEOUS  
TOOLS & SUPPLIES

BRAKE & TIRE  
CHANGING TOOLS

MEASURING  
TOOLS

V-TWIN & METRIC  
HARD PARTS

## Add 10 to 20 CFM to cylinder heads with Mondello Signature Series Valve Seat Cutters

Designed to increase airflow by as much as 20 CFM, these cutters are intended for certain applications. Generally you should use intake cutters on intakes and exhaust on exhausts, but as with most things, there's always an exception. Experiment to find the right combination for you and your customers.



You'll find a wide range of profiles in the Mondello Signature Series Cutters because every head and application is unique. Mondello Signature Series Cutters are affordable enough to allow you to do just that. Need help getting started? Talk to one of our Techxperts™ at 1-800-533-8010. All Cutters This Page Jobber \$39.99 each

**I** Intake      **E** Exhaust      **S** Specialty

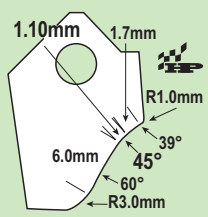

**I** IFT-4539B-HP

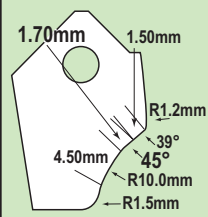

**I** IFT-4529B-HP

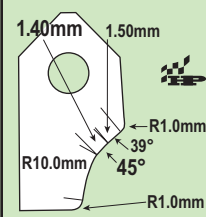

**I** IFT-4524-HD

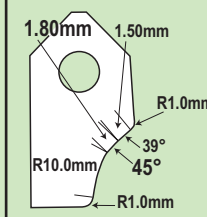

**E** IFT-4524A-HD

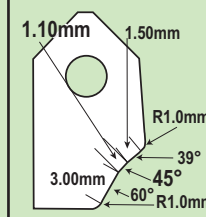

**I** IFT-4560-HD

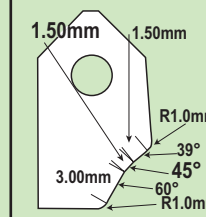

**I** IFT-4560A-HD

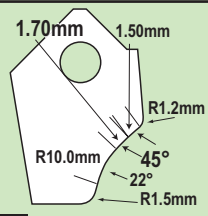

**I** IFT-4522B-HP

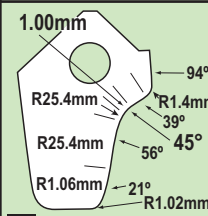

**E** IFT-4556B-HP

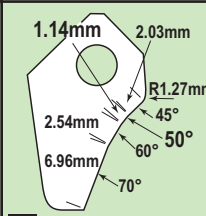

**I** EFT-5060B-HP

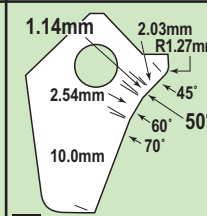

**I** EFT-5061B-HP

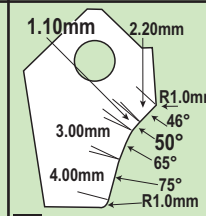

**I** IFT-5065B-HP

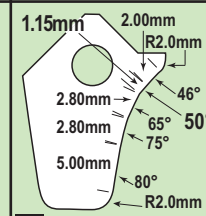

**I** EFT-5046B-HP

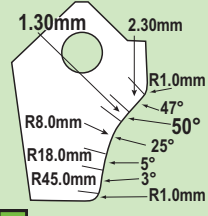

**E** IFT-5025B-HP

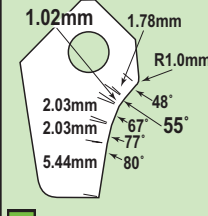

**I** EFT-5567B-HP

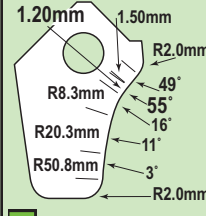

**E** EFT-5557B-HP

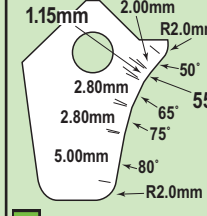

**I** EFT-5550B-HP

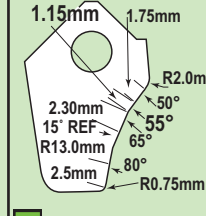

**I** EFT-5565B-HP

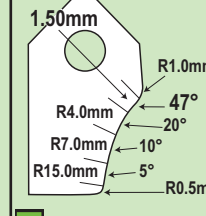

**E** KRT-447

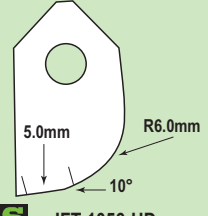

**S** IFT-1056-HD

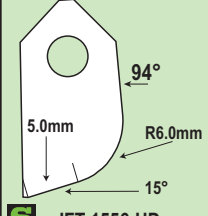

**S** IFT-1556-HD

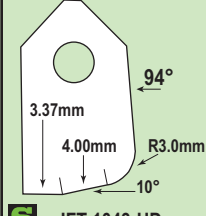

**S** IFT-1043-HD

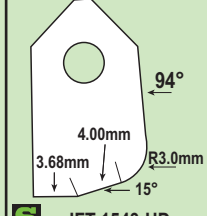

**S** IFT-1543-HD

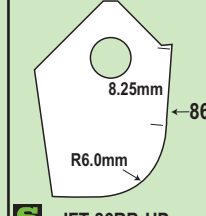

**S** IFT-86RB-HP

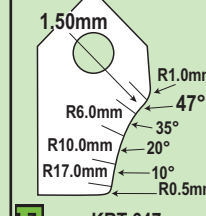

**E** KRT-647

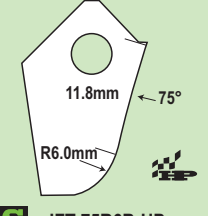

**S** IFT-75R6B-HP

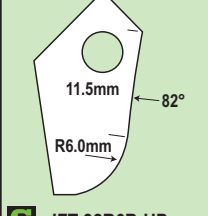

**S** IFT-82R6B-HP

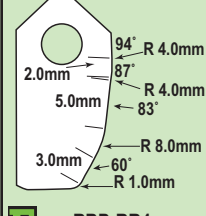

**E** RBP-RR4

**3-Piece High Performance Cutter Kit** **NEW**

- Increase flow & improve horse power with this set
- Order No. **IFT-HP-SET** Jobber \$99.99

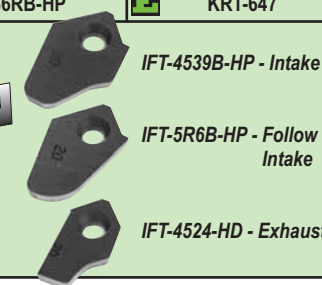



# Radius Profile Seat Cutter Blades

All Cutter Blades on this page Jobber \$39.99

CYLINDER HEAD  
REBUILDING

CLEANING,  
ASSEMBLY & SAFETY

SHORT BLOCK  
REBUILDING

CRANKSHAFT/  
FLYWHEEL GRINDING

MISCELLANEOUS  
TOOLS & SUPPLIES

BRAKE & TIRE  
CHANGING TOOLS

MEASURING  
TOOLS

V-TWIN & METRIC  
HARD PARTS

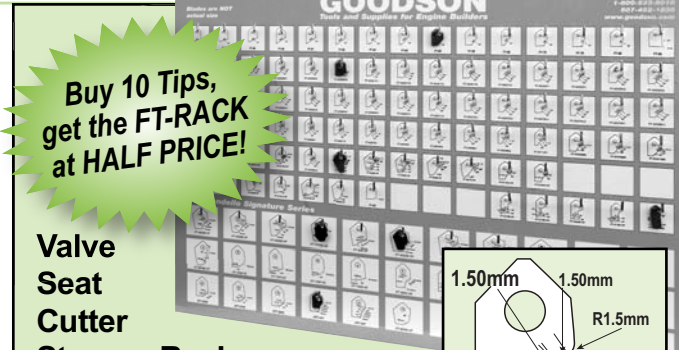

Buy 10 Tips,  
get the FT-RACK  
at HALF PRICE!

## Valve Seat Cutter Storage Rack

- Measures: 17"x13½"x1¼"
- Wall mount • L-hooks included
- Spaces for each stock cutter
- Order No. FT-RACK Jobber \$69.99

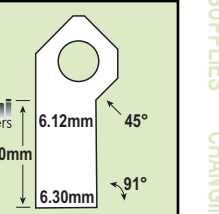
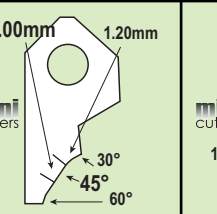
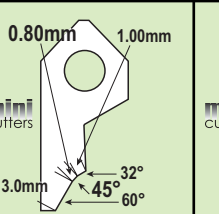
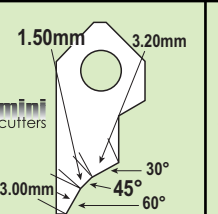
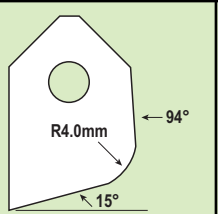
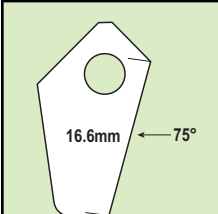
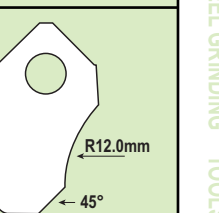
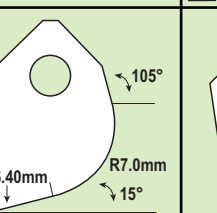
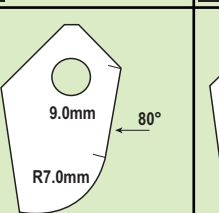
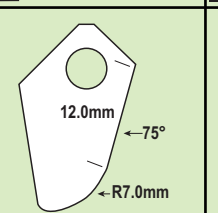
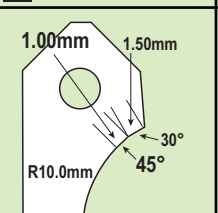
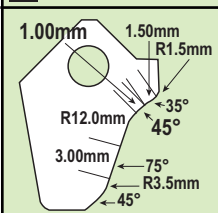
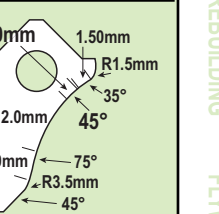
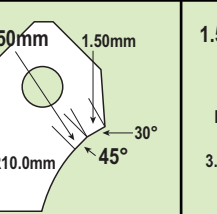
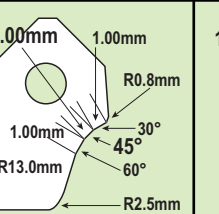
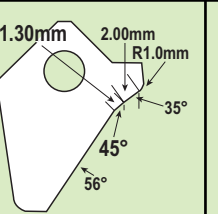
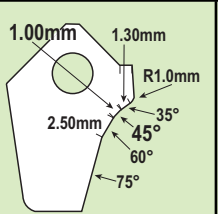
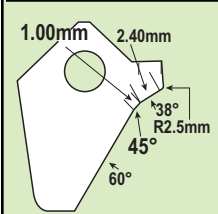
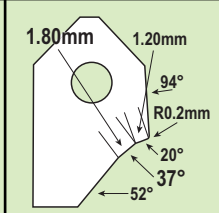
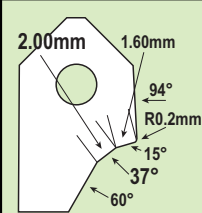
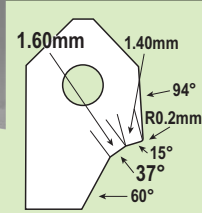
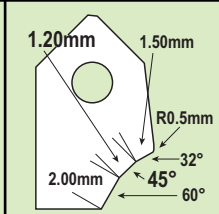
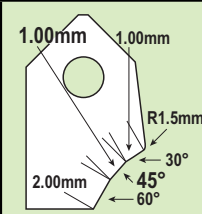
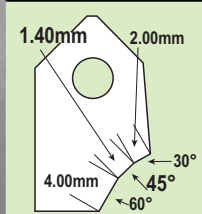
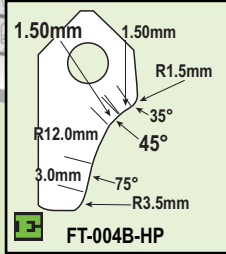

sized for  
**diesel**

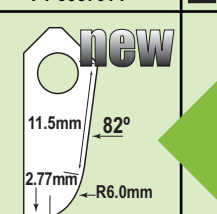
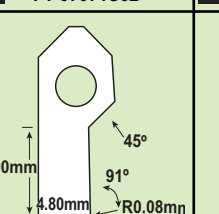
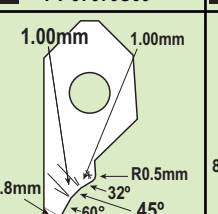
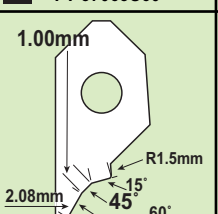
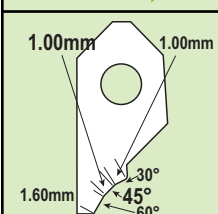
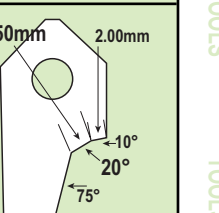
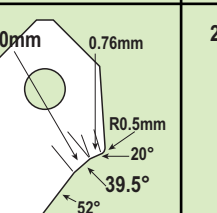
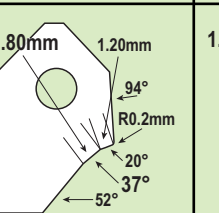
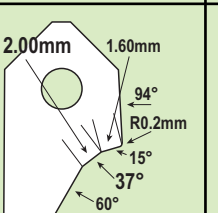
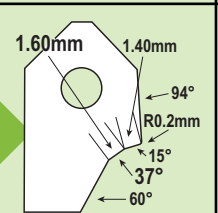

**new**  
**Micro  
Blades**  
Work with  
holders on  
page 5

# 3-D Multi-Angle Seat Cutter Blades

CYLINDER HEAD  
REBUILDING

CLEANING,  
ASSEMBLY & SAFETY

SHORT BLOCK  
REBUILDING

CRANKSHAFT/  
FLYWHEEL GRINDING

MISCELLANEOUS  
TOOLS & SUPPLIES

BRAKE & TIRE  
CHANGING TOOLS

MEASURING  
TOOLS

V-TWIN & METRIC  
HARD PARTS

<p>1.00mm 1.40mm 25° 45° 60° FT-45039U1</p>	<p>1.00mm 1.80mm 25° 45° 60° FT-45039U2</p>	<p>1.00mm 1.20mm 30° 45° 60° FT-45039V1</p>	<p>1.00mm 1.60mm 35° 45° 52° FT-45039W1</p>	<p>1.00mm 1.60mm 35° 45° 55° FT-45039W2</p>	<p>1.00mm 1.60mm 35° 45° 60° FT-45039W3</p>
<p>1.30mm 1.00mm 30° 45° 60° FT-45051V2</p>	<p>1.30mm 1.20mm 30° 45° 60° FT-45051V4</p>	<p>1.30mm 2.00mm 30° 45° 60° FT-45051V1</p>	<p>1.30mm 2.00mm 30° 45° 52° FT-45051V3</p>	<p>1.30mm 2.00mm 37° 45° 52° FT-45051X1</p>	<p>1.40mm 1.00mm 30° 45° 60° FT-45055V1</p>
<p>1.50mm 1.80mm 30° 45° 60° FT-45059V1</p>	<p>1.50mm 1.40mm 30° 45° 60° FT-45059V2</p>	<p>1.50mm 2.00mm 30° 45° 60° FT-45059V3</p>	<p>1.50mm 1.80mm 37° 45° 52° FT-45059X1</p>	<p>1.60mm 1.40mm 25° 45° 60° FT-45063U1</p>	<p>1.60mm 1.80mm 25° 45° 60° FT-45063U2</p>
<p>1.60mm 1.00mm 30° 45° 60° FT-45063V1</p>	<p>1.60mm 1.20mm 30° 45° 60° FT-45063V3</p>	<p>1.60mm 1.80mm 30° 45° 52° FT-45063W1</p>	<p>1.60mm 2.00mm 30° 45° 60° FT-45063V2</p>	<p>1.80mm 1.60mm 30° 45° 60° FT-45071V1</p>	<p>1.90mm 0.80mm 30° 45° 52° FT-45075V2</p>
<p>1.90mm 2.00mm 30° 45° 60° FT-45075V1</p>	<p>2.00mm 1.40mm 25° 45° 60° FT-45079U1</p>	<p>2.00mm 1.80mm 25° 45° 60° FT-45079U2</p>	<p>2.00mm 1.20mm 30° 45° 60° FT-45079V1</p>	<p>2.50mm 1.40mm 25° 45° 60° FT-45098U1</p>	<p>2.50mm 1.80mm 25° 45° 60° FT-45098U2</p>
<p>1.00mm 1.60mm 20° 30° 52° FT-30039T1</p>	<p>1.30mm 1.00mm 15° 30° 45° FT-30051S1</p>	<p>1.30mm 1.80mm 15° 30° 60° FT-30059S1</p>	<p>1.30mm 2.00mm 15° 30° 60° FT-30059S3</p>	<p>1.60mm 2.00mm 15° 30° 45° FT-30063S1</p>	<p>1.80mm 1.40mm 15° 30° 60° FT-30071S1</p>
<p>1.90mm 1.00mm 15° 30° 45° FT-30075S1</p>	<p>2.00mm 1.40mm 15° 30° 60° FT-30079S1</p>	<p>2.00mm 1.80mm 15° 30° 60° FT-30079S2</p>	<p>2.50mm 1.80mm 15° 30° 60° FT-30098S1</p>	<p>2.50mm 2.00mm 15° 30° 60° FT-30098S2</p>	<p>All Blades This Page Jobber \$29.99</p>

# 3-D Single-Angle Seat Cutter Blades

 FT-15	 FT-20	 FT-30	 FT-35	 FT-37	 FT-39
 FT-45	 FT-50	 FT-52 <b>new</b>	 FT-55	 FT-60	 FT-65
 FT-70	 FT-75	 FT-82	 FT-90	 FT-R5	<b>Single Angle Valve Seat Cutter Blades</b> Jobber \$29.99 ea.

CYLINDER HEAD REBUILDING  
CLEANING, ASSEMBLY & SAFETY  
SHORT BLOCK REBUILDING  
CRANKSHAFT/ FLYWHEEL GRINDING  
MISCELLANEOUS TOOLS & SUPPLIES  
BRAKE & TIRE CHANGING TOOLS  
MEASURING TOOLS  
V-TWIN & METRIC HARD PARTS

## Diamond Hand Files

- Choose between 360 & 600 grit
- Use for fine touch-ups on your FT Blades

Description	Jobber	Order No.
Diamond File Set - 1-360 grit & 1-600 grit	\$62.99	DFS-2
600 Grit Files ( 2-pack)	62.99	DFS-6

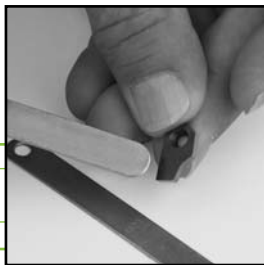

## Custom Cutter Blades are easy as 1-2-3

- 1 – Download the GOODSON Custom Formtool Profile Form from our website. Go to: [www.goodson.com/technical\\_support/Formtool.pdf](http://www.goodson.com/technical_support/Formtool.pdf) Don't have internet access? Call 1-800-533-8010 and ask us to fax you a copy.
- 2 – Fill out the form including a drawing of the cutter you need. Be sure to include all angles, radii, seat widths, etc. Missing information may delay your cutter or result in an incorrect profile.
- 3 – Fax the completed form to GOODSON at 507-452-2907 (or 1-888-466-3909) or e-mail it to [orderdesk@goodson.com](mailto:orderdesk@goodson.com). We will have a blueprint drawn from your specs, which you will need to approve before production begins.

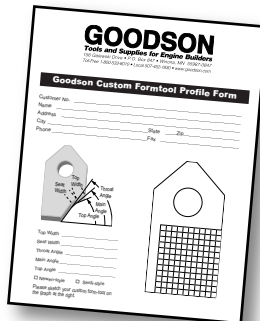

**Custom cutters start at \$98**



## Universal Cutter Blade Sharpener

- Keep your multi-angle cutters sharp with this universal sharpening fixture • 1 1/4" dia. Diamond Lap
- Balanced ball-bearing fan-cooled electric motor
- Variable angle plus/minus 15°
- Lighted on/off rocker switch for easy control
- Safety catch tray with splash guard for lapping oil
- Available in 115V, 60 Hz and 220V 50 Hz

Description	Jobber	Order No.	Incl.
Sharpener Kit 115V	\$1,049.99	3D-SHARP	
Sharpener Kit 230V	1,099.99	3D-SHARP-220	
3D Cutter Holder	34.79	3D-HOLDER	x x
Diamond Lap	188.99	LP-RFA	x x
Dressing Stick	9.49	LP-DS	x x
4 oz. Lapping Oil with Dauber	10.49	LP-LO-4	x x

From our customers:



"At Warrior Racing we invested in the E VM-42 fixture and 3D Fast Cut tooling to insure our valve seat angles are concentric to create the necessary air flow for our 10,000 HP Top Fuel Engines."

- Bob Peck, Warrior Racing, Tipp City, OH, Goodson customer since 2011

CYLINDER HEAD REBUILDING

CLEANING, ASSEMBLY & SAFETY

SHORT BLOCK REBUILDING

CRANKSHAFT/ FLYWHEEL GRINDING

MISCELLANEOUS TOOLS & SUPPLIES

BRAKE & TIRE CHANGING TOOLS

MEASURING TOOLS

V-TWIN & METRIC HARD PARTS

3-D FAST CUT™ SYSTEM

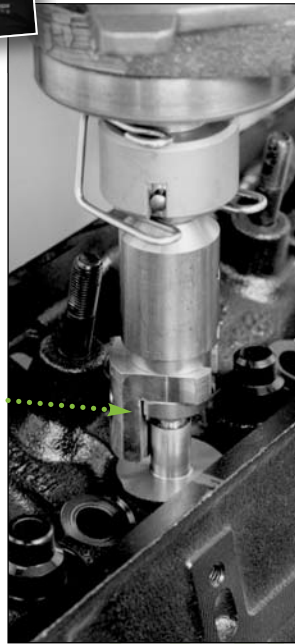
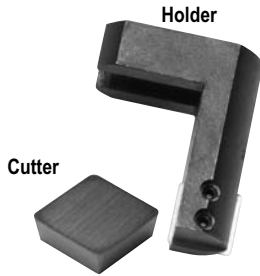

### 3-D Fast Cut Adjustable Spring Pad Cutters

- No need to change tooling, just change the tool holder and start cutting spring pads
- Works with all popular 3-angle cutting systems
- Square blades are indexable and replaceable
- Tool holder includes one blade

#### Tool Holders

Blade Size	Application	Jobber	Order No.
3/8" / 9.53mm	All except Sunnen®	\$174.99	SPC-375
1/2" / 12.70mm	All except Sunnen®	174.99	SPC-500
Sunnen Drive Adaptor		304.99	3D-SUN
3/8" / 9.53mm	Sunnen®	174.99	SUN-375
Lift Clip (fit all except OE Sunnen®)		21.99	3D-CLIP

#### Replacement Carbide Cutters (for all holder styles above)

3/8" / 9.53mm	\$ 16.99	SPCI-375
1/2" / 12.70mm	16.99	SPCI-500

**tech tips** **PROBLEM:** I use a Sunnen® seat and guide machine. I'm having trouble controlling the spring pad cutting process. What do you have that will help?

**SOLUTION:** Goodson has designed a drive adaptor specifically for Sunnen® seat and guide machines with early style tooling. With the OE Sunnen® tooling, there is no way to hold back on the cut. The design of our 3D-SUN drive adaptor incorporates a groove in the drive adaptor so you can use the 3D-CLIP to connect the drive adaptor and the ball head for positive control. It moves when you do.

3D-SUN



Blade Fits Here

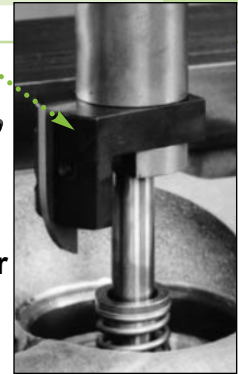

### Remove material and recontour bowls with the GOODSON 3-D Fast Cut™ Bowl Profiler

- Machine seats & bowls on a pair of V8 heads in about 40 minutes
- Remove material to recontour cylinder head bowl areas and unshroud valves in combustion chambers
- Blades can be modified using our sharpener (see page 9)
- Will not work with Sunnen® Ball Heads

Holder Diameter Range	Jobber	Order No.
1.25"-1.87" / 32-48mm	\$166.49	NBN-1
1.57"-2.13" / 40-54mm	166.49	NBN-2

Blades sold separately

NBN-5	NBN-6	NBN-10	NBN-12	NBN-14	NBN-15
\$74.99	\$74.99	\$78.79	\$104.99	\$104.99	\$104.99

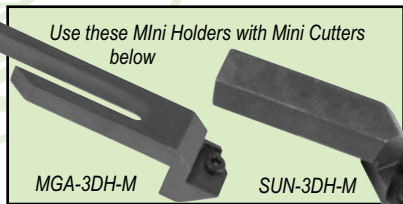
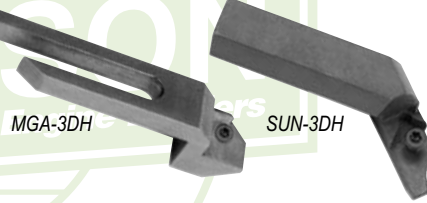

### Convert your Sunnen® or Mira® brazed cutters to 3-D with this simple holder

This blade holder allows you to mount premium, replaceable carbide cutters on your existing MIRA® and Sunnen® ball-type tool holders. Choose from our wide selection of replaceable cutters, previously only available for 3-D Fast Cut™ or similar seat cutting systems.

Description	Jobber	Order No.
Standard Cutter	Mira®	\$169.99
Holders	Sunnen® VSC-Series	174.99
Mini Cutter	Mira®	169.99
Holders	Sunnen®	174.99
Micro Cutters	30°/45°/60°	39.99
	32°/45°/60°	39.99
view profiles	30°/45°/60°	39.99
on page 7	45°/91°	39.99
Replacement Screw (Buy 6 or more, only \$3.99 each)		4.99

## Conversion Calculator

We've tried to convert as many SAE measurements to Metric (and vice versa) as possible. In some cases there hasn't been enough room. If you need to convert a measurement, here are the formulas:

Starting Measurement	Conversion Formula	Converted Measurement
Inches (in)	# Inches x 25.4	Millimeters (mm)
Feet (ft)	# Feet x .0348	Meters (m)
Millimeters (mm)	# Millimeters ÷ 25.4	Inches (in)
Fahrenheit (F)	(5÷9) x (F - 32)	Celsius (C)
Celsius (C)	(9÷5) x (C + 32)	Fahrenheit (F)

Visit [www.goodson.com/blog/2014/04/22/metric-conversion-calculators/](http://www.goodson.com/blog/2014/04/22/metric-conversion-calculators/) for interactive calculators - just plug your numbers into the correct calculator for instant results

# Valve Seat Work

## Precision Valve Seat Run-Out Gauge

- Measure run-out to .0001" directly from the valve seat
- Locked to the pilot
- Dial indicator remains stationary while rotating contact pointer
- Range: .800" to 2.500" diameter

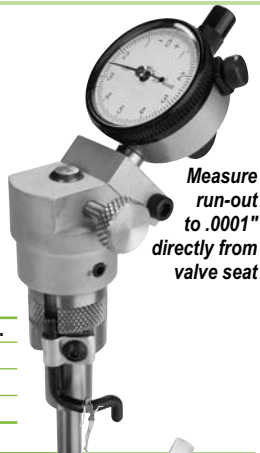

Measure run-out to .0001" directly from valve seat

Pilot Top Size	Jobber	Order No.
.236" (6.0mm)	\$649.99	SCG-236
.375" (9.53mm)	649.99	SCG-375
.385" (9.78mm)	649.99	SCG-385

## Valve Seat Run-Out Gauge

- Hardened guide bushings & contact pilot
- Quick thumb screw set-up
- Jeweled bearing indicator reads to ±.050" with .001" precision
- Range: 1.00"-2.50"



Pilot Size	Jobber	Order No.
.375"	\$149.99	VSG-375
.385"	149.99	VSG-385

Buy 6 or more cans SBF-16 and save 10% off jobber



## Check valve to seat contact with any of these layout fluids

Description	Color	Jobber	Order No.
Layout Fluid Markers	Blue	\$9.99	VBF-2
2 oz. / 59 mL	Red	9.99	VRF-2
Layout Fluid 4oz. / 118mL	Blue	9.99	VBF-4
(includes brush)	Red	9.99	VRF-4
Prussian Blue Machining Paste ¼ oz. / 22mL		8.49	PB-75
Spray Bluing Fluid (Aerosol)*	Blue	9.99	SBF-16*

\*Hazardous Goods Fees Apply When Shipped by Air



## Valve and Seat Scribe finds valve face to seat contact

- Kit includes: tool body, scribe, 1 pilot sleeve, and 6.6mm, 8.0mm, 5/16", 11/32" and 3/8" valve stem sleeves
- Sleeves fit tool body to valve stems & pilots
- Use valve to set point then scribe seat with inner & outer radii
- Grind seat top & throat to match face precisely

Pilot Size	Jobber	Order No.
.385" / 9.78mm Sioux™	\$34.99	ST-30-SX
.375" / 9.53mm B&D	34.99	ST-30-BD

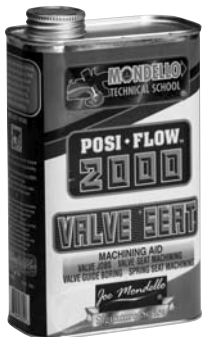

## Machine valve seats to a mirror-like finish with Valve Seat Machining Aid

- Universal - works with any type of cylinder head machining center
- Use full strength
- Safe for metal surfaces
- Works with mineral-based cutting oils, not water based
- Quart (946mL)
- Order No. PF-2020 Jobber \$24.99

Buy 6 or more cans of Cutting & Tapping Fluid and SAVE 10% off Jobber

## Cut through even the hardest metals with Cutting & Tapping Fluid

- Spray clings to the surface of the tool to prolong tool life
- Ideal for stainless steel, high nickel alloys, titanium and more
- Use for reaming, seat cutting and CBN cutting
- Aerosol\* • Order No. CTF-14 Jobber \$12.49

\*Hazardous Goods Fees Apply When Shipped by Air



## Minnesota Fast Freeze instantly chills seats and guides to -50°F / -45.5°C

- Creates interference fit with heated aluminum heads
- Finish seat and guide work faster than ever
- Aerosol\*
- Use on tight bushings, pins, shafts, etc.
- Order No. MFF-8 Jobber \$29.99



Buy 6 or more cans MFF-8 and save 10% off jobber

\*Hazardous Goods Fees Apply When Shipped by Air

## Valve Seat Cutting Fluid

- High silicone content reduces drag on cutters so they last longer
- Promotes smoother cuts
- May be diluted up to 9:1
- Non-aerosol spray



Size	Jobber	Order No.
1 pint spray (473 mL)	\$13.99	SCF-2
1 gallon (3.79 L)	28.49	SCF-10

CYLINDER HEAD REBUILDING

CLEANING, ASSEMBLY & SAFETY

SHORT BLOCK REBUILDING

CRANKSHAFT/ FLYWHEEL GRINDING

MISCELLANEOUS TOOLS & SUPPLIES

BRAKE & TIRE CHANGING TOOLS

MEASURING TOOLS

V-TWIN & METRIC HARD PARTS

# Neway Valve Seat Cutting System

CYLINDER HEAD  
REBUILDING

CLEANING,  
ASSEMBLY & SAFETY

SHORT BLOCK  
REBUILDING

CRANKSHAFT/  
FLYWHEEL GRINDING

MISCELLANEOUS  
TOOLS & SUPPLIES

BRAKE & TIRE  
CHANGING TOOLS

MEASURING  
TOOLS

V-TWIN & METRIC  
HARD PARTS

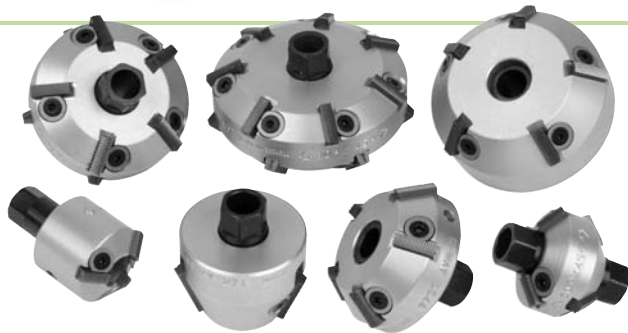

L-R: NCB-253, NCB-250,  
NCB-251, NCB-252,  
NCB-254

L-R:  
NCB-152,  
NCB-154

L-R: NCB-250LC,  
NCB-251LC

L-R: NCB-355,  
NCB-352,  
NCB-354



L-R: NCB-260,  
NCB-265, NCB-266



**Accurate** The Tungsten Carbide blades on these cutters never change shape like abrasives will. You get a perfectly flat, machined surface that will give you an optimal seal and heat transfer.

**Ready to use** Cutter bodies come complete with blades. Most bodies feature replaceable blades (see chart for part numbers and quantities).

**Easy** The Neway Valve Seat Cutting System is very user-friendly. You can turn the cutters by hand with a T-handle or use the EZ-Turn Wrench (**NTW-EZ**) for a continuous turning motion. The EZ-Turn Wrench also includes a 1/2" to 3/8" adaptor **NTW-503-1** to drive all cutter bodies (adaptor also sold separately).

**How to Order** Cutters work in a range from 3/8" smaller and 1/4" larger than the listed cutter body size. Select cutter approximately the same size as your valve head diameter.

Description	Jobber	Order No.
<b>Small Series Cutter Bodies (Use .297" Top Pilots - page 1)</b>		
<b>Cutter Body</b>	<b>Blade</b>	<b>Qty. Replacement</b>
<b>Diameter</b>	<b>Angle</b>	<b>Blade</b>
0.830" / 21.1mm	32°	3 non-replaceable
0.850" / 21.6mm	45°	3 non-replaceable
0.874" / 22.2mm	60°	3 non-replaceable
0.925" / 23.5mm	45°	3 non-replaceable
0.975" / 24.8mm	31°	3 NCB-250
	31°	3 NCB-253
	45°	3 NCB-253
1.000" / 25.4mm	15°	3 NCB-253
	30°	3 NCB-250
	60°	3 NCB-252
	75°	3 NCB-254
1.125" / 28.6mm	31°/46°	3/3 NCB-253
1.312" / 33.3mm	31°/46°	3/3 NCB-251
	15°/60°	3/3 NCB-251, -254
<b>Replacement Blades</b>	<b>Angle</b>	<b>Blade Lgth. ea.</b>
	15-46°	3/8" / 7.9mm \$10.99 <b>NCB-253</b>
		3/8" / 9.53mm 10.99 <b>NCB-250</b>
		1/2" / 12.7mm 10.99 <b>NCB-251</b>
	60-75°	1/2" / 12.7mm 10.99 <b>NCB-252</b>
		3/4" / 19.05mm 10.99 <b>NCB-254</b>
<b>Non-Serrated Correction Blades</b>	60-75°	1/2" / 12.7mm 10.99 <b>NCB-152</b>
<b>Hard Seat Blades</b>	15-46°	3/8" / 9.53mm 10.99 <b>NCB-250LC</b>
		1/2" / 12.7mm 11.99 <b>NCB-251LC</b>
<b>Radius Combustion Chamber Blades</b>		3/8" / 9.53mm 19.99 <b>NCB-355</b>
		1/2" / 12.7mm 19.99 <b>NCB-352</b>
		3/4" / 19.05mm 19.99 <b>NCB-354</b>
Flat Head Screw		\$ 2.29 <b>NCB-260</b>
Wedge for bodies over 1" / 25.4mm		2.29 <b>NCB-265</b>
Wedge for 1" / 25.4mm & smaller bodies		2.29 <b>NCB-266</b>
Tool Kit (includes brush, 2 hex keys and pilot puller)		5.99 <b>NKA-246</b>
Storage Cases	Small (holds 3 pieces)	14.99 <b>NCA-303</b>
	Medium (holds 6 pieces)	19.99 <b>NCA-160</b>
	Large (holds 11 pieces)	29.99 <b>NCA-497</b>
EZ-Turn Wrench		69.99 <b>NTW-EZ</b>
1/2" T-Handle Driver		12.79 <b>NTW-505</b>
3/8" T-Handle Driver		12.79 <b>NTW-513</b>
Drive Adaptor	1/2" to 3/8" / 12.7-9.53mm	11.79 <b>NTW-503-1</b>

Description	Jobber	Order No.
<b>Standard Series Cutter Bodies (Use .375" Top Pilots - page 1)</b>		
<b>Cutter Body Diameter</b>	<b>Blade Angle</b>	<b>Qty. Replacement Blade</b>
1.125" / 28.6mm	30°	3 NCB-250
	45°	3 NCB-250
	60°	3 NCB-252
	75°	3 NCB-254
1.250" / 31.6mm	15°	3 NCB-250
	15°	5 NCB-250
	15°/75°	3/3 NCB-250, -254
	30°	3 NCB-250
	31°	5 NCB-250
	30°/45°	6 NCB-250
	31°/46°	6 NCB-250
	45°	5 NCB-250
	46°	5 NCB-250
	60°	3 NCB-252
1.375" / 35.0mm	15°/60°	5/5 NCB-251, -254
	30°/45°	3/3 NCB-250, -251
1.500" / 38.0mm	15°/75°	3/3 NCB-251, -254
	30°/45°	3/3 NCB-251
	30°/45°	5/5 NCB-251
	31°/46°	10 NCB-251
	60°	3 NCB-254
	70°	3 NCB-254
1.750" / 44.5mm	15°/60°	5/5 NCB-251, -254
	30°/45°	10 NCB-251
	31°/46°	10 NCB-251
	55°	5 NCB-251
	60°	3 NCB-254
	75°	3 NCB-254
2.000" / 50.8mm	31°/46°	10 NCB-251
	15°/60°	5/5 NCB-251, -254
	30°/45°	5/5 NCB-251
	50°	5 NCB-251
	60°	5 NCB-254
2.25" / 57.0mm	50°	5 NCB-251
	55°	5 NCB-251
	30°/45°	7/7 NCB-251
	15°/60°	5/5 NCB-251, -254
2.50" / 63.5mm	30°/45°	7/7 NCB-251
	50°	7 NCB-251
	55°	7 NCB-251
	60°	5 NCB-254
	70°	7 NCB-254

Goodson can now make almost any Newway kit! Call or visit [goodson.com](http://goodson.com) for more information

## Neway Easy Turn Wrench

- Turn Newway cutters continuously
- Produces a smooth seat quickly and easily
- Improves control of material removal
- Spring loaded for improved control
- Includes drive adaptor to convert 1/2" to 3/8"

Description	Jobber	Order No.
Easy Turn Wrench	\$69.99	NTW-EZ
Drive Adaptor	11.79	NTW-503-1



## Neway T-Handle Drivers

- Use to turn Newway cutters
- Produces a smooth seat quickly and easily
- Two sizes to fit small series cutter bodies and standard series cutter bodies
- 1/2" to 3/8" adaptor available

Description	Jobber	Order No.
3/8" Hex for Small Series Bodies	\$12.79	NTW-513
1/2" Hex for Standard Series Bodies	12.79	NTW-505
1/2" to 3/8" Adaptor	11.79	NTW-503-1

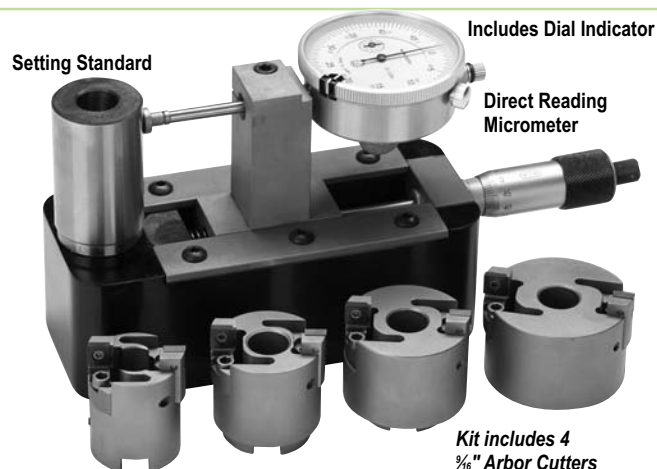

## Customize Counterbore Cutters with the GOODSON Adjustable Counterbore Cutter Kit

- Cutter assemblies feature positive stop adjusting screws to prevent cutters from changing dimensions when in use
- Direct reading micrometer and dial indicator for fast, accurate set-up • 8 cutter assemblies to choose from, covering a range from 1.25" to 3.00" diameter
- Kit substitutions are available, call to inquire
- Heavy duty billet steel construction

Complete Kit	Jobber	Order No.	Incl.
3/8" / 14.3mm Arbor	\$1,699.99	DWA-300	▼
<b>Cutter Assemblies (in/mm)</b>			
3/8" Arbor	1.250"-1.375" / 31.8-34.9	\$419.99	DWA-250 x
	1.375"-1.500" / 34.9-38.1	419.99	DWA-375 x
	1.500"-1.750" / 38.1-44.5	419.99	DWA-302 x
	1.750"-2.000" / 44.5-50.8	419.99	DWA-303 x
	2.000"-2.250" / 50.8-57.2	419.99	DWA-304
	2.250"-2.500" / 57.2-63.5	419.99	DWA-305
	2.500"-2.750" / 63.5-69.9	419.99	DWA-306
	2.750"-3.000" / 69.9-76.2	419.99	DWA-307
Cutting Insert	36.49	DKB-7	x
Set Screw	13.29	DKS-7	x
Wrench	8.99	FT-WRENCH	x

To use the Counterbore Cutter Kit with Kwik-Way & Peterson Machines you will need to adapt the 3/8" cutter to fit the 1/2" drive. Use a DCW wear sleeve from the charts below.

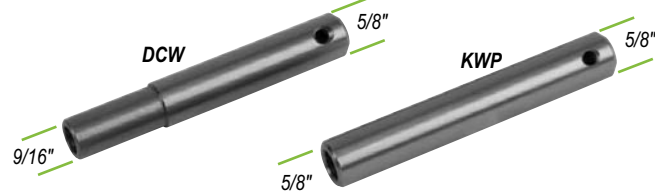

## Wear Sleeves for Counter Bore Cutters

Wear Sleeves	
For 3/8" (14.27mm) arbor DCW & DWI style seat cutters	
Pilot Top Size	Order No.
.375" (9.53mm)	DCW-375
.385" (9.78mm)	DCW-385
.437" (11.10mm)	DCW-437
Jobber	\$78.79

Wear Sleeves	
For 1/2" / 15.87mm arbor KWP & KPI style seat cutters	
Pilot Top Size	Order No.
.375" (9.53mm)	KWP-375
.385" (9.78mm)	KWP-385
.437" (11.10mm)	KWP-437
Jobber	\$71.99

DCD-375/DCD-385

DCW-60-375

Counterbore cutters on page 12

DVR-SER

DCW-375

CD-MT3

KW-022

## Counterbore Cutter Drive Adaptors

Cutter Drivers	Jobber	Order No.
#3 MT Driver	\$329.99	CD-MT3
1/2" / 12.7 mm Driver (fits Jacobs chuck)	259.99	KW-022
Fits .750" Bridgeport Collet		
3/8" arbor, .375" pilot	\$120.29	DCW-60-375
3/8" arbor, .385" pilot	120.29	DCW-60-385
3/8" arbor, .375" pilot	109.99	KWP-60-375
3/8" arbor, .385" pilot	109.99	KWP-60-385
Ball Head Driver .375" pilot, 3/8" arbor	242.79	DCD-375
Ball Head Driver .385" pilot, 3/8" arbor	242.79	DCD-385
3/8" Driver for Serdi & Rottler SG-9A, SG-9M	339.99	DVR-SER
3/8" Driver for Serdi & Rottler SG-9A, SG-9M	299.99	DVR-SER-58

CYLINDER HEAD REBUILDING  
CLEANING, ASSEMBLY & SAFETY  
SHORT BLOCK REBUILDING  
FLYWHEEL GRINDING  
CRANKSHAFT/ FLYWHEEL GRINDING  
MISCELLANEOUS TOOLS & SUPPLIES  
BRAKE & TIRE CHANGING TOOLS  
MEASURING TOOLS  
V-TWIN & METRIC HARD PARTS

From our customers:

"We have been doing business with Goodson for over 10 years. They have outstanding customer service and a great selection of specialty tooling and parts for Harleys."

- Bob LaGuardia, Diamond Bar Choppers, Diamond Bar CA, Goodson customer since 2000

CYLINDER HEAD REBUILDING

CLEANING, ASSEMBLY & SAFETY

SHORT BLOCK REBUILDING

CRANKSHAFT/ FLYWHEEL GRINDING

MISCELLANEOUS TOOLS & SUPPLIES

BRAKE & TIRE CHANGING TOOLS

MEASURING TOOLS

V-TWIN & METRIC HARD PARTS



## Indexable Counterbore Cutters

These indexable counterbore cutters eliminate down time from having brazed cutters reset or sharpened. You can service them right in your own shop! Each cutter body includes 2 carbide cutter tips with 4 cutting edges. When one edge wears, simply rotate the tip to a new cutting edge. You'll also get insert screws and a wrench with every cutter body.



### DWI-SERIES

- Fits DCM Tech, Sunnen, and Winona Van Norman
- 9/16" / 14.3mm arbor

### KPI-SERIES

- Fits Kansas Instruments, Kwik-Way and Peterson
- 5/8" / 15.9mm arbor

Size	mm	DWI-Series		KPI-Series	
		DCM Tech, WVN	Jobber	K.I., KW, Peterson	Jobber
		(9/16" arbor)		(5/8" arbor)	
1.000"	25.40	\$209.99	DWI-1000	—	—
1.062"	26.97	209.99	DWI-1062	—	—
1.125"	28.57	209.99	DWI-1125	—	—
1.187"	30.15	209.99	DWI-1187	—	—
1.250"	31.75	209.99	DWI-1250	\$209.99	KPI-1250
1.312"	33.32	209.99	DWI-1312	209.99	KPI-1312
1.375"	34.93	209.99	DWI-1375	209.99	KPI-1375
1.437"	36.50	209.99	DWI-1437	209.99	KPI-1437
1/4" Replacement Cutting Insert for Cutters above				27.79	SCI-250-B
Replacement Screw for SCI-250-B				4.99	SCS-T7
Allen Wrench for SCS-T7				6.99	SCW-T7

Size	mm	DWI-Series		KPI-Series	
		DCM Tech, WVN	Jobber	K.I., KW, Peterson	Jobber
		(9/16" arbor)		(5/8" arbor)	
1.500"	38.10	\$209.99	DWI-1500	\$209.99	KPI-1500
1.562"	39.67	209.99	DWI-1562	209.99	KPI-1562
1.625"	41.28	209.99	DWI-1625	209.99	KPI-1625
1.687"	42.85	209.99	DWI-1687	209.99	KPI-1687
1.750"	42.85	209.99	DWI-1750	209.99	KPI-1750
1.812"	44.45	209.99	DWI-1812	209.99	KPI-1812
1.875"	47.63	209.99	DWI-1875	209.99	KPI-1875
1.937"	49.20	209.99	DWI-1937	209.99	KPI-1937
2.000"	50.80	209.99	DWI-2000	209.99	KPI-2000
2.062"	52.37	209.99	DWI-2062	209.99	KPI-2062
2.125"	53.98	209.99	DWI-2125	209.99	KPI-2125
2.187"	55.55	209.99	DWI-2187	209.99	KPI-2187
2.250"	57.15	209.99	DWI-2250	209.99	KPI-2250
3/8" Replacement Cutting Insert for Cutters above				44.29	SCI-375-B
Replacement Screw for SCI-375-B				1.49	SCS-T15
Torx Wrench for SCW-T15				4.99	SCW-T15



## Minnesota Fast Freeze

- Creates interference fit with heated aluminum heads
- Finish seat and guide work faster than ever
- Aerosol\*
- Use on tight bushings, pins, shafts, etc.
- Order No. MFF-8 Jobber \$29.99
- \* Hazardous Goods Fees Apply When Shipped Air



## Nickel-Chrome Valve Seats For a Variety Of Applications

OD	ID	Depth	Order No.	OD	ID	Depth	Order No.
1.250"	0.812"	1/4"	VS-1250	1.625"	1.375"	7/32"	VS-1625A
1.312"	1.000"	1/4"	VS-1312	1.687"	1.375"	1/4"	VS-1687
1.375"	1.062"	1/4"	VS-1375	1.750"	1.500"	1/4"	VS-1750
1.437"	1.125"	1/4"	VS-1437	1.812"	1.500"	1/4"	VS-1812
1.500"	1.187"	1/4"	VS-1500	1.875"	1.562"	1/4"	VS-1875
1.562"	1.250"	1/4"	VS-1562	1.937"	1.625"	1/4"	VS-1937
1.562"	1.312"	7/32"	VS-1562A	2.000"	1.625"	1/4"	VS-2000
1.625"	1.312"	1/4"	VS-1625				Jobber \$6.99

Buy 12 or more, save 10% off jobber

Buy 12 or more, save 10% off jobber



See page 5 for valve seat removal tools that fit 3-D Fast Cut

## Valve Seat Removers – A Low-Cost Way to Pull Valve Seat Inserts

- Use to pry out valve seat inserts or stubborn grease seals
- Three angles available
- Not recommended for use on aluminum heads
- Set includes one of each angle

Description	Jobber	Order No.
3-Pc. Set	\$129.99	VSP-SET
90°	47.99	VSP-90
100°	47.99	VSP-100
120°	47.99	VSP-120

## for Engine Builders



## Valve Seat Drivers For Fast Seat Installation

- Pneumatic Drivers install seats faster, easier and without galling
- Driver Head ID is .75" / 19.05mm

Description	Jobber	Order No.
<b>Manual Drivers</b>		
.375" / 9.53mm and .385" / 9.78mm ID	\$29.99	VSD-202-G
<b>Driver Heads</b>		
1.000" thru 1.125" Seats / 25.4 - 28.6mm	\$39.99	VSD-203-G
1.250" thru 1.375" Seats / 31.8 - 34.9mm	39.99	VSD-204-G
1.500" thru 1.625" Seats / 38.1 - 41.3mm	39.99	VSD-205-G
1.750" thru 1.875" Seats / 44.5 - 47.6mm	39.99	VSD-206-G
2.000" thru 2.125" Seats / 50.8 - 54.0mm	39.99	VSD-207-G
1.750" thru 2.000" Seats / 44.5 - 50.8mm	29.99	VSD-HD
<b>Pneumatic Drivers</b>		
.375" / 9.53mm and .385" / 9.78mm ID	\$29.99	PSD-385
.437" / 11.10mm ID	29.99	PSD-437

Use with Press Fit Lube (PFL-200) or Fluid Weld (FW-2)





# Valve Lapping Tools & Supplies

## Petroleum Based Lapping Compound

- Silicone-carbide, grease-based compound
- Precise mating between valves and seats for fast cutting



Grit	Size	Jobber	Order No.
400	2 oz. / 56.7g	\$11.99	VLC-2-400
600	2 oz. / 56.7g	11.99	VLC-2-600
800	2 oz. / 56.7g	11.99	VLC-2-800
1200	2 oz. / 56.7g	15.99	VLC-2-1200
120, 280	2 oz. / 56.7g ea.	27.79	VLC-4
120	1 lb. / 453.6g	54.99	VLC-120
180	1 lb. / 453.6g	54.99	VLC-180
280	1 lb. / 453.6g	54.99	VLC-280

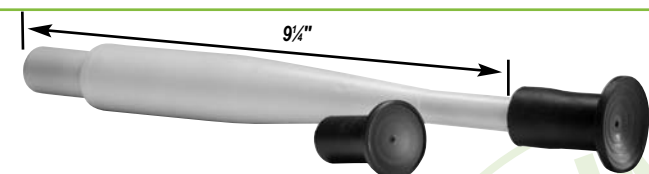

## Vacuum Style Lapping Stick

- Press the spring-loaded vacuum pump for a firm hold – stays on until you release the vacuum
- Includes 3 cup sizes (also sold separately)

Description	Cup ID	Jobber	Order No.
Vacuum Lapping Stick 9 1/4" Long		\$32.99	VLV-50
Replacement Cups	19.1mm / 0.750" dia.	.415"	7.99 VLV-3/4
	25.4mm / 1.000" dia.	.415"	7.99 VLV-1
	31.8mm / 1.250" dia.	.415"	7.99 VLV-1 1/4

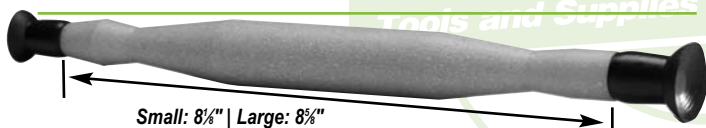

## Traditional Valve Lapping Sticks

- Oil resistant polyethylene handles
- Locking tabs eliminate cup slippage

Description	Cup ID	Jobber	Order No.
Small Lapping Stick 8 1/4" Long		\$7.99	VLS-15
Replacement Cups	15.9mm / 0.625" dia.	.156"	5.99 VLS-5/8
	20.6mm / 0.813" dia.	.230"	5.99 VLS-13/16
Large Lapping Stick 8" Long		7.99	VLS-30
Replacement Cups	28.6mm / 1.125" dia.	.380"	5.99 VLS-1 1/8
	34.9mm / 1.375" dia.	.380"	5.99 VLS-1 3/8

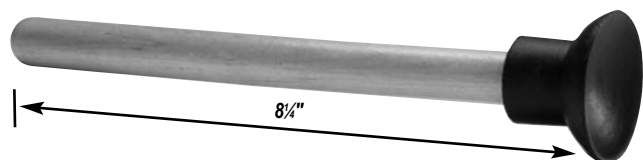

## "The Plunger" Hand Valve Lapping Stick

- Large diameter for sure grip
- For 2" and larger valves

Description	Cup ID	Jobber	Order No.
Hand Valve Lapping Stick 8 1/4" Long		\$7.99	VLS-75
Replacement Cup	44.5mm / 1.750" dia.	.313"	4.99 VLS-1 3/4

## Air Powered Valve Lapping Tool

- Operates on 90psi
- Includes air tool and 3 replacement cups • Air actuated ... no electricity needed • Cups also sold separately



Description	Cup ID	Jobber	Order No.
Air Powered Valve Lapping Tool		\$399.99	AVLP-300
Replacement Cups	21mm / 0.827" dia.	.230"	8.99 AVLP-301
	33mm / 1.299" dia.	.380"	8.99 AVLP-302
	38mm / 1.496" dia.	.380"	8.99 AVLP-303

## Mechanical Valve Lapping Tool

- Auto oscillation with a simple crank
- Includes blade drive for slotted valves

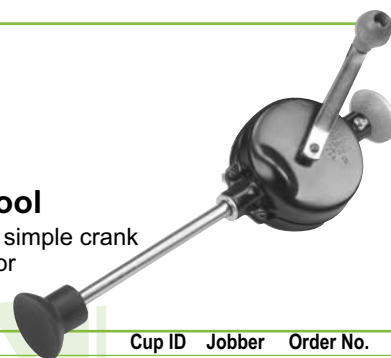

Description	Cup ID	Jobber	Order No.
Mechanical Valve Lapping Tool		\$24.99	VL-EB
Replacement Cups	33.3mm / 1.313" dia.	.297"	3.99 VLS-1 5/16
	44.5mm / 1.750" dia.	.313"	4.99 VLS-1 3/4

## Powered Lapping Tool

- Change rotary action into an effective oscillating motion • Drive with a power drill
- Makes lapping faster and easier • Includes 2 cup sizes



Description	Cup ID	Jobber	Order No.
Complete Tool		\$169.99	VLP-100
Replacement Cups	22.2mm / 0.875" dia.	.460"	9.99 VLP-10
	25.4mm / 1.000" dia.	.460"	9.99 VLP-20



Buy 6 or more cans SBF-16 and save 10%

## Check valve to seat contact with any of these layout fluids

Description	Color	Jobber	Order No.
Layout Fluid Markers	Blue	\$9.99	VBF-2
2 oz. / 59 mL	Red	9.99	VRF-2
Layout Fluid 4oz. / 118mL	Blue	9.99	VBF-4
	Red	9.99	VRF-4
Prussian Blue Machining Paste 1/4 oz. / 22mL		8.49	PB-75
Spray Bluing Fluid (Aerosol)*	Blue	9.99	SBF-16*

\*Hazardous Goods Fees Apply When Shipped by Air



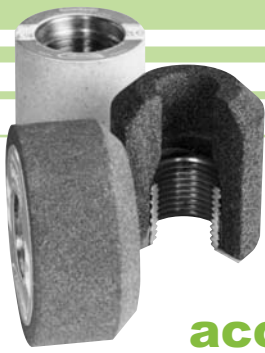

# Goodson seat wheels are built to grind seats accurately and outlast the competition

- Brass bushings resist galling or seizing to the holder
- Heat-cured, permanent epoxy bonding prevents loose bushings
- Bushings are set deep to expose the most abrasive for long life
- Each wheel is pre-trued and checked to assure accurate, vibration-free grinding

Ordering is easy!



- 1 - Find the diameter (valve head diameter + 1/8" to 1/4").
- 2 - Find the angle you need (you can modify angles with our Valve Seat Stone Dresser, page 20).
- 3 - Select the abrasive to match your job.



Fits Kwik-Way 13/16"x13 thread

## GP

**General Purpose**  
Removes material from cast-iron seats or inserts. Ideal for antiques.



## S

**Stellite**  
Specially formulated to grind Stellite and other types of hardened seat inserts, ie. Diesel & Industrial.



## NC

**Nickel Chrome**  
For aluminum heads with chrom-alloy seat inserts. Won't load up or groove. Speckled.



## 6 ABRASIVE FORMULAS TO CHOOSE FROM

## CB

**Cool Blue**  
Superior general purpose stone for high performance Beryllium seats. Cuts faster. For tractors and trucks with diesel engines.



## F

**Finish**  
Gives an ideal final finish with minimal stock removal.

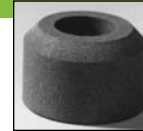

## R

**Ruby**  
The original Black & Decker composition, general purpose stone.



Custom angles and sizes are available in house. Call for more information.

Colors may vary due to manufacturing processes

Size		General Purpose (GP)			Cool Blue (CB)		Finishing (F)		Stellite (S)		
Inch	mm	Jobber	00°	30°	45°	00°	45°	30°	45°	00°	45°
1 1/4"	32	\$13.99	KW-1000-GP	KW-1030-GP	KW-1045-GP	KW-1000-CB	KW-1045-CB		KW-1045-F	KW-1000-S	KW-1045-S
1 1/8"	33	13.99	KW-1000A-GP		KW-1045A-GP	KW-1000A-CB	KW-1045A-CB				
1 3/8"	35	13.99	KW-1100-GP	KW-1130-GP	KW-1145-GP	KW-1100-CB	KW-1145-CB	KW-1130-F	KW-1145-F	KW-1100-S	KW-1145-S
1 1/2"	36	13.99	KW-1100A-GP		KW-1145A-GP	KW-1100A-CB	KW-1145A-CB		KW-1145A-F	KW-1100A-S	KW-1145A-S
1 1/2"	38	13.99	KW-1200-GP	KW-1230-GP	KW-1245-GP	KW-1200-CB	KW-1245-CB	KW-1230-F	KW-1245-F	KW-1200-S	KW-1245-S
1 5/8"	39	13.99	KW-1200A-GP		KW-1245A-GP		KW-1245A-CB		KW-1245A-F	KW-1200A-S	KW-1245A-S
1 5/8"	41	13.99	KW-1300-GP	KW-1330-GP	KW-1345-GP	KW-1300-CB	KW-1345-CB	KW-1330-F	KW-1345-F	KW-1300-S	KW-1345-S
1 11/16"	43	13.99	KW-1300A-GP		KW-1345A-GP	KW-1300A-CB	KW-1345A-CB		KW-1345A-F	KW-1300A-S	KW-1345A-S
1 3/4"	44	13.99	KW-1400-GP	KW-1430-GP	KW-1445-GP	KW-1400-CB	KW-1445-CB	KW-1430-F	KW-1445-F	KW-1400-S	KW-1445-S
1 7/8"	47	13.99	KW-1500-GP	KW-1530-GP	KW-1545-GP	KW-1500-CB	KW-1545-CB	KW-1530-F	KW-1545-F	KW-1500-S	KW-1545-S
2"	51	13.99	KW-1600-GP	KW-1630-GP	KW-1645-GP	KW-1600-CB	KW-1645-CB	KW-1630-F	KW-1645-F	KW-1600-S	KW-1645-S
2 1/8"	54	13.99	KW-1700-GP	KW-1730-GP	KW-1745-GP	KW-1700-CB	KW-1745-CB	KW-1730-F	KW-1745-F	KW-1700-S	KW-1745-S
2 1/4"	57	13.99	KW-1800-GP	KW-1830-GP	KW-1845-GP	KW-1800-CB	KW-1845-CB		KW-1845-F	KW-1800-S	KW-1845-S
2 3/8"	60	13.99	KW-1900-GP	KW-1930-GP	KW-1945-GP	KW-1900-CB	KW-1945-CB				
2 1/2"	63	13.99	KW-2000-GP	KW-2030-GP	KW-2045-GP	KW-2000-CB	KW-2045-CB				
2 5/8"	67	15.99	KW-2100-GP	KW-2130-GP	KW-2145-GP	KW-2100-CB	KW-2145-CB				
2 3/4"	70	16.99	KW-2200-GP	KW-2230-GP	KW-2245-GP	KW-2200-CB	KW-2245-CB				
2 7/8"	73	16.99	KW-2200A-GP	KW-2230A-GP	KW-2245A-GP	KW-2200A-CB	KW-2245A-CB				

Size		Nickel Chrome (NC)		Ruby (R)			
Inch	mm	Jobber	00°	45°	Jobber	00°	45°
1"	25	\$16.99	KW-700-NC	KW-745-NC	\$17.99	KW-700-R	KW-745-R
1 1/8"	27	16.99	KW-800-NC	KW-845-NC	17.99	KW-800-R	KW-845-R
1 1/8"	28	16.99	KW-900-NC	KW-945-NC	17.99	KW-900-R	KW-945-R
1 1/4"	32	14.99	KW-1000-NC	KW-1045-NC	14.99	KW-1000-R	KW-1045-R
1 3/8"	35	14.99	KW-1100-NC	KW-1145-NC	14.99	KW-1100-R	KW-1145-R
1 1/2"	36	14.99	KW-1100A-NC	KW-1145A-NC			
1 1/2"	38	14.99	KW-1200-NC	KW-1245-NC	14.99	KW-1200-R	KW-1245-R
1 5/8"	39	14.99	KW-1200A-NC	KW-1245A-NC			
1 5/8"	41	14.99	KW-1300-NC	KW-1345-NC	14.99	KW-1300-R	KW-1345-R
1 11/16"	43	14.99	KW-1300A-NC	KW-1345A-NC			
1 3/4"	44	14.99	KW-1400-NC	KW-1445-NC	14.99	KW-1400-R	KW-1445-R
1 7/8"	47	14.99	KW-1500-NC	KW-1545-NC	14.99	KW-1500-R	KW-1545-R
2"	51	14.99	KW-1600-NC	KW-1645-NC	14.99	KW-1600-R	KW-1645-R
2 1/8"	54	15.99	KW-1700-NC	KW-1745-NC			
2 1/4"	57	15.99	KW-1800-NC	KW-1845-NC			
2 3/8"	60	15.99	KW-1900-NC	KW-1945-NC			
2 1/2"	63	15.99	KW-2000-NC	KW-2045-NC			
2 5/8"	67	16.99	KW-2100-NC	KW-2145-NC			
2 3/4"	70	16.99	KW-2200-NC	KW-2245-NC			
2 7/8"	73	16.99	KW-2200A-NC	KW-2245A-NC			

## 45° Large Diameter Valve Seat Wheels



• Fits Kwik-Way 13/16"x13 thread

Size		General Purpose	Nickel-Chrome	Cool Blue
Inch	mm	Order No.	Order No.	Order No.
3"	76.2	KWL-2345-GP	KWL-2345-NC	KWL-2345-CB
3 1/4"	82.5	KWL-2445-GP	KWL-2445-NC	KWL-2445-CB
3 1/2"	88.9	KWL-2545-GP	KWL-2545-NC	KWL-2545-CB
3 3/4"	92.3	KWL-2645-GP	KWL-2645-NC	KWL-2645-CB
4"	101.6	KWL-2745-GP	KWL-2745-NC	KWL-2745-CB
Jobber		\$24.99	\$24.99	\$24.99



# Save 10% on 10!



Order 10 or more Valve Seat Wheels (any combination, pages 16-18) and we'll give you 10% off jobber

# SX

Fits Sioux™, KO Lee, US, Thor, Skil, Winona 11/16"x16 thread

Colors may vary due to manufacturing processes

Size	General Purpose (GP)					Cool Blue (CB)		Ruby				
	Inch	mm	Jobber	00°	30°	45°	60°	00°	45°	Jobber	00°	45°
7/8"	22									\$22.99	SX-500-R	SX-545-R
15/16"	24									22.99	SX-600-R	SX-645-R
1"	25									22.99	SX-700-R	SX-745-R
1 1/16"	27									22.99	SX-800-R	SX-845-R
1 1/8"	28	\$19.99	SX-900-GP	SX-930-GP	SX-945-GP					22.99	SX-900-R	SX-945-R
1 3/16"	30	19.99	SX-900A-GP		SX-945A-GP							
1 1/4"	32	13.49	SX-1000-GP	SX-1030-GP	SX-1045-GP	SX-1060-GP	SX-1000-CB	SX-1045-CB		13.49	SX-1000-R	SX-1045-R
1 1/2"	33	13.49	SX-1000A-GP		SX-1045A-GP		SX-1000A-CB	SX-1045A-CB				
1 3/8"	35	13.49	SX-1100-GP	SX-1130-GP	SX-1145-GP	SX-1160-GP	SX-1100-CB	SX-1145-CB		13.49	SX-1100-R	SX-1145-R
1 1/2"	36	13.49	SX-1100A-GP		SX-1145A-GP		SX-1100A-CB	SX-1145A-CB				
1 1/2"	38	13.49	SX-1200-GP	SX-1230-GP	SX-1245-GP	SX-1260-GP	SX-1200-CB	SX-1245-CB		13.49	SX-1200-R	SX-1245-R
1 5/8"	39	13.49	SX-1200A-GP		SX-1245A-GP		SX-1200A-CB	SX-1245A-CB				
1 5/8"	41	13.49	SX-1300-GP	SX-1330-GP	SX-1345-GP	SX-1360-GP	SX-1300-CB	SX-1345-CB		13.49	SX-1300-R	SX-1345-R
1 7/8"	43	13.49	SX-1300A-GP		SX-1345A-GP		SX-1300A-CB	SX-1345A-CB				
1 3/4"	44	13.49	SX-1400-GP	SX-1430-GP	SX-1445-GP	SX-1460-GP	SX-1400-CB	SX-1445-CB		13.49	SX-1400-R	SX-1445-R
1 7/8"	47	13.49	SX-1500-GP	SX-1530-GP	SX-1545-GP	SX-1560-GP	SX-1500-CB	SX-1545-CB		13.49	SX-1500-R	SX-1545-R
2"	51	13.49	SX-1600-GP	SX-1630-GP	SX-1645-GP	SX-1660-GP	SX-1600-CB	SX-1645-CB		13.49	SX-1600-R	SX-1645-R
2 1/8"	54	13.49	SX-1700-GP	SX-1730-GP	SX-1745-GP		SX-1700-CB	SX-1745-CB		13.49	SX-1700-R	SX-1745-R
2 1/4"	57	13.49	SX-1800-GP	SX-1830-GP	SX-1845-GP	SX-1860-GP	SX-1800-CB	SX-1845-CB		13.49	SX-1800-R	SX-1845-R
2 3/8"	60	13.49	SX-1900-GP	SX-1930-GP	SX-1945-GP	SX-1960-GP	SX-1900-CB	SX-1945-CB		13.49	SX-1900-R	SX-1945-R
2 1/2"	63	13.49	SX-2000-GP	SX-2030-GP	SX-2045-GP		SX-2000-CB	SX-2045-CB		13.49	SX-2000-R	SX-2045-R
2 5/8"	66	13.49	SX-2100-GP	SX-2130-GP	SX-2145-GP		SX-2100-CB	SX-2145-CB				
2 3/4"	70	15.99	SX-2200-GP	SX-2230-GP	SX-2245-GP		SX-2200-CB	SX-2245-CB				
2 7/8"	73	15.99	SX-2200A-GP	SX-2230A-GP	SX-2245A-GP		SX-2200A-CB	SX-2245A-CB				

Size	Stellite (S)			Finishing (F)				Nickel Chrome						
	Inch	mm	Jobber	00°	30°	45°	Jobber	00°	30°	45°	Jobber	00°	30°	45°
1/2"	12.7										\$22.99	SX-200-NC		
5/8"	14.3										22.99	SX-200A-NC		
3/4"	15.9										22.99	SX-300-NC		
7/8"	17.4										22.99	SX-300A-NC		
1 1/8"	19.1										22.99	SX-400-NC		
1 1/4"	20.6										22.99	SX-400A-NC		
1 1/2"	22						\$22.99	SX-500-F	SX-545-F	22.99	SX-500-NC		SX-545-NC	
1 3/8"	24						22.99	SX-600-F	SX-645-F	22.99	SX-600-NC		SX-645-NC	
1"	25						22.99	SX-700-F	SX-745-F	22.99	SX-700-NC		SX-745-NC	
1 1/16"	27						22.99	SX-800-F	SX-845-F	22.99	SX-800-NC		SX-845-NC	
1 1/8"	28	\$19.99	SX-900-S	SX-930-S	SX-945-S		19.99	SX-900-F	SX-930-F	SX-945-F	19.99	SX-900-NC	SX-930-NC	SX-945-NC
1 3/16"	30	19.99	SX-900A-S		SX-945A-S		19.99	SX-900A-F		SX-945A-F	19.99	SX-900A-NC		SX-945A-NC
1 1/4"	32	12.99	SX-1000-S	SX-1030-S	SX-1045-S		12.99	SX-1000-F	SX-1030-F	SX-1045-F	13.99	SX-1000-NC	SX-1030-NC	SX-1045-NC
1 1/2"	33	12.99	SX-1000A-S		SX-1045A-S		12.99	SX-1000A-F		SX-1045A-F	13.99	SX-1000A-NC		SX-1045A-NC
1 3/8"	35	12.99	SX-1100-S	SX-1130-S	SX-1145-S		12.99	SX-1100-F	SX-1130-F	SX-1145-F	13.99	SX-1100-NC	SX-1130-NC	SX-1145-NC
1 1/2"	36	12.99	SX-1100A-S		SX-1145A-S		12.99	SX-1100A-F		SX-1145A-F	13.99	SX-1100A-NC		SX-1145A-NC
1 1/2"	38	12.99	SX-1200-S	SX-1230-S	SX-1245-S		11.49	SX-1200-F	SX-1230-F	SX-1245-F	13.99	SX-1200-NC	SX-1230-NC	SX-1245-NC
1 5/8"	39	12.99	SX-1200A-S		SX-1245A-S		11.49	SX-1200A-F		SX-1245A-F	13.99	SX-1200A-NC		SX-1245A-NC
1 5/8"	41	12.99	SX-1300-S	SX-1330-S	SX-1345-S		11.49	SX-1300-F	SX-1330-F	SX-1345-F	13.99	SX-1300-NC	SX-1330-NC	SX-1345-NC
1 7/8"	43	12.99	SX-1300A-S		SX-1345A-S		11.49	SX-1300A-F		SX-1345A-F	13.99	SX-1300A-NC		SX-1345A-NC
1 3/4"	44	12.99	SX-1400-S	SX-1430-S	SX-1445-S		11.49	SX-1400-F	SX-1430-F	SX-1445-F	13.99	SX-1400-NC	SX-1430-NC	SX-1445-NC
1 7/8"	47	12.99	SX-1500-S	SX-1530-S	SX-1545-S		11.49	SX-1500-F	SX-1530-F	SX-1545-F	13.99	SX-1500-NC	SX-1530-NC	SX-1545-NC
2"	51	12.99	SX-1600-S	SX-1630-S	SX-1645-S		11.49	SX-1600-F	SX-1630-F	SX-1645-F	13.99	SX-1600-NC	SX-1630-NC	SX-1645-NC
2 1/8"	54	12.99	SX-1700-S	SX-1730-S	SX-1745-S		11.49	SX-1700-F	SX-1730-F	SX-1745-F	13.99	SX-1700-NC	SX-1730-NC	SX-1745-NC
2 1/4"	57	12.99	SX-1800-S	SX-1830-S	SX-1845-S		11.49	SX-1800-F	SX-1830-F	SX-1845-F	13.99	SX-1800-NC	SX-1830-NC	SX-1845-NC
2 3/8"	60	12.99	SX-1900-S	SX-1930-S	SX-1945-S		13.99	SX-1900-F	SX-1930-F	SX-1945-F	13.99	SX-1900-NC	SX-1930-NC	SX-1945-NC
2 1/2"	63	12.99	SX-2000-S	SX-2030-S	SX-2045-S		13.99	SX-2000-F	SX-2030-F	SX-2045-F	13.99	SX-2000-NC	SX-2030-NC	SX-2045-NC
2 5/8"	66										15.99	SX-2100-NC	SX-2130-NC	SX-2145-NC
2 3/4"	70										15.99	SX-2200-NC	SX-2230-NC	SX-2245-NC
2 7/8"	73										15.99	SX-2200A-NC	SX-2230A-NC	SX-2245A-NC

All Valve Seat Wheels are guaranteed against manufacturing defects for 1 year from original purchase date

CYLINDER HEAD REBUILDING  
CLEANING, ASSEMBLY & SAFETY  
SHORT BLOCK REBUILDING  
FLYWHEEL GRINDING  
CRANKSHAFT/ FLYWHEEL GRINDING  
MISCELLANEOUS TOOLS & SUPPLIES  
BRAKE & TIRE CHANGING TOOLS  
MEASURING TOOLS  
V-TWIN & METRIC HARD PARTS



**BD**

Black & Decker, Van Dorn 5/16"x16 thread

**Save 10% on 10!**  
 Order 10 or more Valve Seat Wheels (any combination, pages 16-18) and we'll give you 10% off jobber



**SO**

Snap-On (Blue Point) 5/8"x18 thread

Size		General Purpose (GP)			Stellite (S)			General Purpose (GP)			Stellite (S)			
Inch	mm	Jobber	00°	30°	45°	Jobber	00°	45°	Jobber	45°	00°	Jobber	45°	00°
1 1/4"	32	\$12.49	BD-1000-GP	BD-1030-GP	BD-1045-GP	\$12.99	BD-1000-S	BD-1045-S	\$12.99	SO-1045-GP	SO-1000-S			
1 5/16"	33	12.49	BD-1000A-GP		BD-1045A-GP	12.99	BD-1000A-S	BD-1045A-S						
1 3/8"	35	12.49	BD-1100-GP	BD-1130-GP	BD-1145-GP	12.99	BD-1100-S	BD-1145-S	12.99	SO-1145-GP	SO-1100-S			
1 7/16"	36	12.49	BD-1100A-GP		BD-1145A-GP	12.99	BD-1100A-S	BD-1145A-S						
1 1/2"	38	12.49	BD-1200-GP	BD-1230-GP	BD-1245-GP	12.99	BD-1200-S	BD-1245-S	12.99	SO-1245-GP	SO-1200-S			
1 9/16"	39	12.49	BD-1200A-GP		BD-1245A-GP	12.99	BD-1200A-S	BD-1245A-S						
1 5/8"	41	12.49	BD-1300-GP	BD-1330-GP	BD-1345-GP	12.99	BD-1300-S	BD-1345-S	12.99	SO-1345-GP	SO-1300-S			
1 11/16"	43	12.49	BD-1300A-GP		BD-1345A-GP	12.99	BD-1300A-S	BD-1345A-S						
1 3/4"	44	12.49	BD-1400-GP	BD-1430-GP	BD-1445-GP	12.99	BD-1400-S	BD-1445-S	12.99	SO-1445-GP	SO-1400-S			
1 7/8"	47	12.49	BD-1500-GP	BD-1530-GP	BD-1545-GP	12.99	BD-1500-S	BD-1545-S	12.99	SO-1545-GP	SO-1500-S			
2"	51	12.49	BD-1600-GP	BD-1630-GP	BD-1645-GP	12.99	BD-1600-S	BD-1645-S	12.99	SO-1645-GP	SO-1600-S			
2 1/8"	54	12.49	BD-1700-GP	BD-1730-GP	BD-1745-GP	12.99	BD-1700-S	BD-1745-S						
2 1/4"	57	12.49	BD-1800-GP	BD-1830-GP	BD-1845-GP	12.99	BD-1800-S	BD-1845-S						
2 3/8"	60	12.49	BD-1900-GP	BD-1930-GP	BD-1945-GP	12.99	BD-1900-S	BD-1945-S						

**Large Diameter Valve Seat Wheels**

- Specially designed bushing allows you to use stone with either angle toward workpiece
- Three abrasive formulations to choose from: General Purpose, Nickel Chrome, Cool Blue
- SXL wheels feature 30° on one face, 45° on the other



General Purpose		SX Double Angle 7/8"x14 thread		KW Single Angle 13/16"x13 thread	
Inch	mm	Jobber	Order No.	Jobber	Order No.
2 5/8"	66.7	\$23.49	SXL-2145-GP		
3"	76.2	23.99	SXL-2345-GP	\$24.99	KWL-2345-GP
3 1/4"	82.5	23.99	SXL-2445-GP	24.99	KWL-2445-GP
3 1/2"	88.9	23.99	SXL-2545-GP	24.99	KWL-2545-GP
3 3/4"	92.3	23.99	SXL-2645-GP	24.99	KWL-2645-GP
4"	101.6	23.99	SXL-2745-GP	24.99	KWL-2745-GP
Nickel Chrome		7/8"-14 thread		13/16"-13 thread	
Inch	mm	Jobber	Order No.	Jobber	Order No.
3"	76.2	\$23.99	SXL-2345-NC	\$24.99	KWL-2345-NC
3 1/4"	82.5	23.99	SXL-2445-NC	24.99	KWL-2445-NC
3 1/2"	88.9	23.99	SXL-2545-NC	24.99	KWL-2545-NC
3 3/4"	92.3	23.99	SXL-2645-NC	24.99	KWL-2645-NC
4"	101.6	23.99	SXL-2745-NC	24.99	KWL-2745-NC
Cool Blue		7/8"-14 thread		13/16"-13 thread	
Inch	mm	Jobber	Order No.	Jobber	Order No.
3"	76.2	\$23.99	SXL-2345-CB	\$24.99	KWL-2345-CB
3 1/4"	82.5	23.99	SXL-2445-CB	24.99	KWL-2445-CB
3 1/2"	88.9	23.99	SXL-2545-CB	24.99	KWL-2545-CB
3 3/4"	92.3	23.99	SXL-2645-CB	24.99	KWL-2645-CB
4"	101.6	23.99	SXL-2745-CB	24.99	KWL-2745-CB

**Sioux-Style 1703 Valve Seat Stone Holder and .572" Top Pilots**

- Use with SXL-series Valve Seat Wheels at left
- Stones fit SX-1703 or SX-HOLDER with SX-78 bushing (pg. 21)



Description	Jobber	Order No.
Sioux-Style Holder (7/8"-14 Thread)	\$219.99	SX-1703
.572" Top Pilots		
in	mm	
.562"	14.27	\$157.99 P-5562S
.563"	14.30	157.99 P-5563S
.564"	14.33	157.99 P-5564S
.625"	15.88	157.99 P-5625S
.626"	15.90	157.99 P-5626S
.627"	15.92	157.99 P-5627S
.628"	15.95	157.99 P-5628S



**Extra Large Diameter SX Valve Seat Wheels**

- Double angle: 30° on one side; 45° on the other
- Use with your OE Sioux™ 1703-5 stone holder
- 1" hole (no threads)

General Purpose		Nickel Chrome			
Inch	mm	Jobber	Order No.	Jobber	Order No.
4"	101.6	\$39.99	SXXL-2745-GP	\$39.99	SXXL-2745-NC
4 1/4"	108.0	39.99	SXXL-2845-GP	39.99	SXXL-2845-NC
4 1/2"	114.3	39.99	SXXL-2945-GP	39.99	SXXL-2945-NC
4 3/4"	120.7	43.99	SXXL-3045-GP	43.99	SXXL-3045-NC
5"	127.0	43.99	SXXL-3145-GP	43.99	SXXL-3145-NC



CYLINDER REBUILDING  
 CLEANING, ASSEMBLY & SAFETY  
 SHORT BLOCK REBUILDING  
 CRANKSHAFT/ FLYWHEEL GRINDING  
 MISCELLANEOUS TOOLS & SUPPLIES  
 BRAKE & TIRE CHANGING TOOLS  
 MEASURING TOOLS  
 V-TWIN & METRIC HARD PARTS

# Air & Electric Seat Grinder Motors

**new**



## Flex Drive (SGF) Heavy Duty Electric Motor Unit

- Heavy duty electric motor
- Flex Drive allows for slight operator misalignment
- 11,500 RPM
- Weighs 12 lbs. • 3/5 HP • 7.5 Amps

Description	Jobber	Order No.
110V, 50/60Hz	\$1,399.99	031-3000-15
220V, 50/60Hz	1,499.99	031-3000-35
Replacement Nose Assembly	679.99	031-3005-17

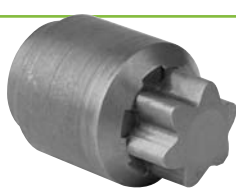

034-3112-00



031-3112-17

## Replacement Drive Assemblies

- Easy to install
- Always keep one on hand for emergencies

Description	Jobber	Order No.
Spline Drive	\$74.99	034-3112-00
Hex Drive with Leather Washer	74.99	031-3112-17
Replacement Leather Washer	3.99	031-1009-41

**new**



## Kwik-Way 45° Hex Drive (SGH) Electric Motor Unit

- Heavy duty electric motor
- 11,500 RPM • Weighs 9 lbs. • 3/5 HP • 7.5 amps
- Use with Hex Drive Stone Holders (page 21)

031-3112-17

Description	Jobber	Order No.
110V, 50/60Hz	\$1,299.99	031-3100-20
220V, 50/60Hz	1,399.99	031-3100-27
Nose Cone Assembly	679.99	031-3105-12
Hex Drive Assembly with Leather Washer	74.99	031-3112-17

**new**



## 45° (SGK) Sioux-Style Spline Drive Electric Motor Unit

- Heavy duty electric motor • 11,500 RPM
- Weighs 9 lbs. • 3/5 HP • 7.5 amps
- Use with SX Stone Holder (page 21)

034-3112-00

Description	Jobber	Order No.
110V, 50/60Hz	\$1,329.99	031-3100-21
220V, 50/60Hz	1,499.99	031-3100-28
Nose Cone Assembly	679.99	034-3105-00
Replacement Spline Drive Assembly	74.99	034-3112-00



## Sioux-Style Spline Drive 90° Angle High-Speed Air Driver

- 1/4" air inlet • Max 1.0 HP
- 2 1/2" wheel capacity
- Weighs 5 1/2 lbs / 2.5 kg
- 10,000 RPM (governed)
- Order No. **1792AG**
- Jobber \$367.49

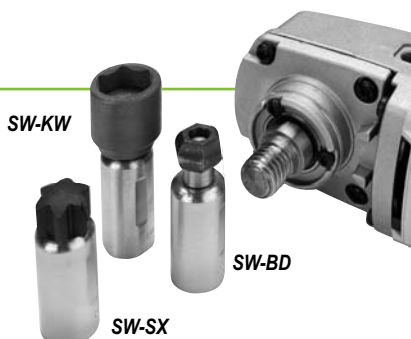

## Valve Seat Grinder Adaptors

- Turn your 4 1/2" Angle Grinder with 3/8"x11 threads into a Valve Seat Grinder
- Available for Sioux, Black & Decker and Kwik-Way
- Stone holders and pilots available separately

Description	Jobber	Order No.
Spline-Drive (Sioux-Style) Adaptor	\$129.99	SW-SX
Hex-Ball (Black & Decker) Adaptor	129.99	SW-BD
Hex Socket (Kwik-Way) Adaptor	129.99	SW-KW



## Universal 4500 RPM Air Driver and Adaptors

- Planetary gear set-up reduces speed to 4500 RPM for best finish, more control and increased torque
- Use vertically to reduce side load on stones
- Weighs just 2 lbs./ .91 kg
- Adaptors available for a variety of stone holders
- Precision clamping collet and wrenches included
- Use with bounce springs (pg. 20) for best results

Description	Jobber	Order No.
4500 RPM Air Driver	\$139.99	AG-4500
Hexball Driver	79.99	ADA-BDS
Kwik-Way Drive Adaptor	79.99	ADA-KW
Sioux™ Drive Adaptor	79.99	ADA-SX

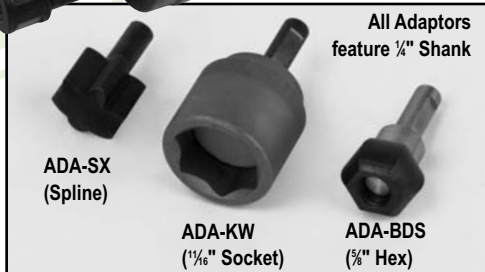

CYLINDER HEAD REBUILDING  
CLEANING, ASSEMBLY & SAFETY  
SHORT BLOCK  
FLYWHEEL GRINDING  
CRANKSHAFT/  
MISCELLANEOUS TOOLS & SUPPLIES  
BRAKE & TIRE CHANGING TOOLS  
MEASURING TOOLS  
V-TWIN & METRIC HARD PARTS

# From our customers:

"It has been a long time since I have seen such a great vendor as these people, they are simply great. I give them an A+++ rating and hope to deal with them more."  
 - Wayne Hudson, Hillboro, Oregon (via Facebook), Goodson customer since 2014

CYLINDER HEAD REBUILDING  
 CLEANING, ASSEMBLY & SAFETY  
 SHORT BLOCK REBUILDING  
 CRANKSHAFT/ FLYWHEEL GRINDING  
 MISCELLANEOUS TOOLS & SUPPLIES  
 BRAKE & TIRE CHANGING TOOLS  
 MEASURING TOOLS  
 V-TWIN & METRIC HARD PARTS



Easy to read scale is marked in 1° increments

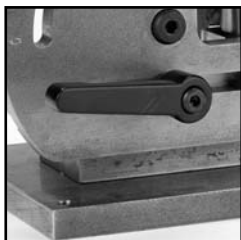

Positive locking adjustment levers stay where you set them



Includes Premium Diamond Dresser (G-13P)



Rigid construction holds dresser firmly to produce a uniform finish

**Goodson exclusive**

See page NP-4 for our Heavy-Duty Dresser

## Universal Valve Seat Wheel Dressing Stand

- Uses 1/2" pilot for the dresser pilot • Infinitely adjustable from 0° to 90°
- Scale marked in 1" increments • Dress stones up to 4" diameter
- Includes Premium dresser diamond • Base has pre-drilled holes for easy mounting to your bench

Description	Jobber	Order No.	Incl.
Universal Dressing Stand for Standard Diameter Wheels	\$599.99	SWD-UNI	▼
Replacement Premium Dressing Diamond (8mm x 1.25mm)	76.29	G-13P	x
Dressing Stand Riser Bushings for SWD-UNI (.250" & .875" Tall)	9.99	SK-9-10	x
Dressing Stand Pilots			
will require shortening to work	.375" Top	35.99	P-5343N
with the dressing stand	.385" Top	47.99	P-5343S
	.437" Top	57.99	P-5343K

See pages 16-21 for valve seat stones, stone holders, air drivers, etc.



Stones and Holders sold separately

**American Made**



WorldwideShipping

## Valve Seat Height Gauge

- Adjusts for all popular valve seat diameters • Gauge accurate to .001"
- Seat contact probe aligns on valve seat while gauge rides along the fire deck • Pilot aligns in valve guide
- Fully adjustable seat contact probe and gauge positions allow tool to fit popular seat diameters from .750" to 3.00"



Description	Fits Pilot	Jobber	Order No.
Valve Seat Height Gauge Kit	.375"	\$94.99	VSHG-375
Replacement Dial Indicator		27.99	EDI-1

## Standard Bounce Spring Set

- Includes one each of three lengths: 1" / 24.5mm, 1 1/2" / 38.1mm and 2" / 50.8mm
- ID = .450" / 11.4mm
- OD = .570" / 14.5mm
- Order No. **BSS-100** Jobber \$16.99

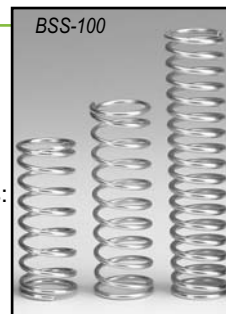

### tech tips

from the techxperts™

Goodson recommends using bounce springs with your Valve Seat Stones to prevent damage to the stone and the seat. This is especially important with the very small stones.

## Seat Stone Removal Tool

Once in a while a valve seat stone will be so tight on the stone holder that it's almost impossible to get off. That's why we came up with this tool. Simply fasten it to your bench with screws or bolts (not included) or clamp it in a vise, set the holder onto the fixture and twist the stone off easily.

Descripton	Jobber	Order No.
Sioux-Style	\$24.99	SX-SRT
Kwik-Way Style	24.99	KW-SRT



## Small Diameter Bounce Springs

- ID = .406"/10.3mm
- OD = .500"/12.7mm

Length / mm	Jobber	Order No.
1.10" / 27.9	\$7.99	BS-1
1.67" / 42.4	7.99	BS-2
3.00" / 76.2	7.99	BS-3

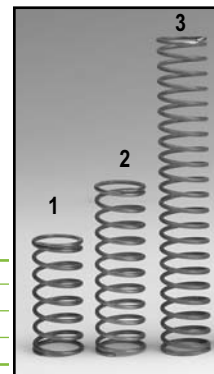

# Seat Stone Holders, Adaptors & More



## Valve Seat Stone Holders & Accessories

• Ball-bearing stone holders • Ideal replacements for worn holders • Save time by having several holders set up with commonly used sizes, compositions or angles of seat stones



031-0300-64    031-0300-80    031-0300-85    031-0300-56    031-0300-30    KW-437    SX-1672    SX-HOLDER    SX-1702BB    BDS-HOLDER

### .437" Pilot, 1/8"x13 Thread Kwik-Way Stone Holders

	Jobber	Order No.
All Kwik-Way Holders are rebuildable unless noted		
Flex-Drive Stone Holder with Stabilizer & Coupling	\$399.99	031-0300-64
Flex-Drive Stone Holder only	379.99	031-0300-85
Hex-Drive Stone Holder w/o Spring Plunger	349.99	031-0300-56
Hex-Drive Stone Holder with Spring Plunger	349.99	031-0300-30
Kwik-Way Style (not rebuildable)	167.99	KW-437

### .385" Pilot, 1/8"x16 Thread Sioux-Style Stone Holders

	OE #	Jobber	Order No.
Short Body (Spline)	1672	\$109.99	SX-1672
Sioux-Style (Spline)	1702	125.99	SX-HOLDER
5/8" Hex Drive	1702BB	179.99	SX-1702BB



Accessories	Jobber	Order No.
Stabilizer Assembly with Bronze Bushing	\$49.99	031-0126-60
Heavy-Duty Twisted Cable Steel Coupling	79.99	031-0304-10
Replacement Hex Drive Body Cap	69.99	031-0302-95
Replacement Spring Plunger Assembly	9.99	031-0313-97
Leather Vibration Reducer (3 pc.) For KW-Holders	11.99	KHW-3
Valve Seat Stone Removal Tool	24.99	KW-SRT

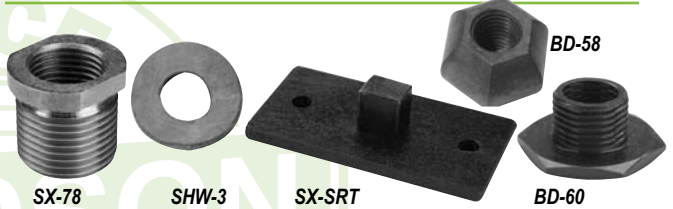

Accessories	Jobber	Order No.
Sioux™ Conversion Bushings 1/8"x16 to 7/8"x14	\$ 9.99	SX-78
Leather Vibration Reducer (3 pc.) For SX-Holders	11.99	SHW-3
Standard Bounce Spring Set (3pc.)	16.99	BSS-100
Valve Seat Stone Removal Tool	24.99	SX-SRT



**Rebuild Kits**  
**For Hex Drive Stone Holder without Spring Plunger** \$189.99    034-0002-00  
 Includes 2 Bearings, Bearing Sleeve, Bearing Lock Nut, Sleeve Key, Hex Cap & Garter Spring



**For Hex Drive Stone Holder with Spring Plunger** \$199.99    034-0002-15  
 Includes 2 Bearings, Bearing Sleeve, Bearing Lock Nut, Sleeve Key, Hex Cap & Spring Plunger Assembly



**For Flex Drive Stone Holder** \$199.99    034-0003-25  
 Includes 2 Bearings, Bearing Sleeve, Heavy Duty Flex Coupling, Inner Sleeve Key & Set Screw

Rebuild kit components are not available individually

### .375" Pilot, 1/8"x16 Thread Black & Decker Stone Holders

	OE #	Jobber	Order No.
Black & Decker Style	BD-HOLDER	\$199.99	BDS-HOLDER
Includes BD-60 adaptor to convert 9/16"x16 to 11/16"x16 Sioux-style stones			
Accessories	Jobber	Order No.	
Black & Decker 5/8" Hexball 5/8"x24 thread	\$59.99		BD-58
5/8"-16 to 1/2"-16 Adaptor for Sioux™	8.99		BD-60



## Grinding Wheel Adaptors

Description	Jobber	Order No.
1/8"-13 (KW) Threaded Stones to 1/8"-16 Threaded Holders (Sioux™, KO Lee)	\$59.99	031-0390-02
1/8"-13 (KW) Threaded Stones to 3/8"-16 Threaded Holders (Black & Decker)	59.99	031-0391-00
1/8"-13 (KW) Threaded Stones to 3/8"-18 Threaded Holders (Kwik-Way)	59.99	031-0393-04
3/8"-18 (KW) Threaded Stones to 1/8"-13 Threaded Holders (Kwik-Way) requires 031-0202-71 Dresser Pilot (above)	59.99	031-1310-65

**Billet Aluminum** \$44.99    TS-5  
**Tooling Stand** Accommodates tooling using 3/8" or larger pilots. Perfect for stone holders! Room for up to 5 tools.

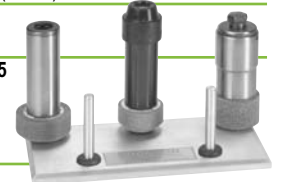

CYLINDER HEAD REBUILDING  
 CLEANING, ASSEMBLY & SAFETY  
 SHORT BLOCK REBUILDING  
 FLYWHEEL GRINDING  
 CRANKSHAFT/ MISCELLANEOUS TOOLS & SUPPLIES  
 BRAKE & TIRE CHANGING TOOLS  
 MEASURING TOOLS  
 V-TWIN & METRIC HARD PARTS

# Valve Refacing Wheels

## Precision made wheels for superior performance on your machine

We stock more than 40 individual valve refacer wheels, each one designed for a specific machine. Our 4" general purpose wheel for Black & Decker is different from our 4" general purpose wheel for Sioux. We won't compromise on performance just to simplify our inventory. Your valve refacer requires a certain type of grit, grade and bond and Goodson delivers. All Goodson Valve Refacing Wheels are designed to be used with mineral based grinding oils such as VGO-10 or VGO-SD10. Goodson guarantees all valve refacing wheels against manufacturing defects for 1 year from original purchase date.

Choose from these types: **S** = for grinding Stellite, **T** = for grinding Titanium, **GP** = for general purpose grinding and **CB** = for general purpose grinding of harder materials. Stone color may vary due to manufacturing process.

To Fit	Use	Dia x Ht x Arb	Shape	Type	Color	Fits Models	OE No.	Jobber	Order No.
Black & Decker	Valve	4" x 1" x 5/8"	Offset	GP	Orange	A, B, C, LW, M,	33056	\$ 41.99	<b>GV-146</b>
		4" x 1" x 5/8"	Offset	CB	Blue	A, B, C, LW, M,	Goodson Spec	31.79	<b>GV-146-CB</b>
Van Dorn	Valve	4" x 1" x 5/8"	Offset	S	Ruby	MW, N, NW, NWB	16371	29.99	<b>GV-144</b>
		5" x 1" x 5/8"	Offset/20°	GP	Pink	P, PC, PCB, T, TD, TG	34131	44.99	<b>GV-156</b>
	Stem	4" x 1 1/8" x 1/2"	Cup	GP	Ruby	All models	20939	29.99	<b>GV-145</b>
Comec	Valve	215 x 35 x 76mm	Flared	GP	Gray	VR416, RV-516	7604	154.99	<b>GV-925</b>
		100 x 50 x 20mm	Cup	GP	White	VR416, RV-516	7606	54.79	<b>GV-928</b>
IDL Sunnen	Valve	8" x 1 1/4" x 1 1/2"	Flared	GP	White	CG-50,-80,-82, V-90, VR-7000	8230	129.99	<b>GV-823</b>
		8" x 1 1/4" x 1 1/2"	Flared	GP	Gray	CG-50,-80,-82, V-90, VR-7000	VR1703	174.99	<b>GV-825</b>
		8" x 1 1/4" x 1 1/2"	Flared	S	White	CG-50,-80,-82, V-90, VR-7000	Goodson Spec	119.99	<b>GV-821</b>
		8" x 1 1/4" x 1 1/2"	Flared	S	Pink	CG-50,-80,-82, V-90, VR-7000	8230-3	89.99	<b>GV-826</b>
		8" x 1 1/4" x 1 1/2"	Flared	T	Green	CG-50,-80,-82, V-90, VR-7000	VR1704	114.99	<b>GV-827</b>
	Stem	8" x 1 1/4" x 1 1/2"	Flared	GP	Ruby	CG-80, CG-82, V-90, VR-7000	VR1701	104.99	<b>GV-824</b>
Kwik-Way	Valve	4" x 3/4" x 7/8"	Offset	GP	Gray	P, C, D, A	010-0400-19	27.99	<b>GV-254</b>
		4 1/2" x 7/8" x 7/8"	Offset	GP	Black	CV, SK, KK, VC, SV, XC	010-0450-10	57.99	<b>GV-257</b>
		4 1/2" x 7/8" x 7/8"	Offset	S	Gray	CV, SK, KK, VC, SV, XC	010-0457-03	41.79	<b>GV-259</b>
		5" x 7/8" x 7/8"	Offset	GP	Orange	EVS, VS	Goodson Spec	57.99	<b>GV-250</b>
		5" x 7/8" x 7/8"	Offset	GP	White	EVS, VS	Goodson Spec	46.99	<b>GV-251</b>
		5" x 7/8" x 7/8"	Offset	GP	Gray	EVS, VS	010-0509-01	46.99	<b>GV-252</b>
		5" x 7/8" x 7/8"	Offset	S	Gray	EVS, VS	010-0507-07	52.99	<b>GV-253</b>
		5" x 7/8" x 7/8"	Offset	T	Green	EVS, VS	010-0508-04	99.99	<b>GV-255</b>
		7" x 1" x 7/8"	Offset	GP	Gray	SVS, SVS-2	010-0709-00	59.99	<b>GV-280</b>
		7" x 1" x 7/8"	Offset	CB	Blue	SVS, SVS-2	Goodson Spec	69.99	<b>GV-280-CB</b>
		7" x 1" x 7/8"	Offset	S	White	SVS, SVS-2	010-0707-50	94.99	<b>GV-281</b>
		7" x 1" x 7/8"	Offset	T	Green	SVS, SVS-2	010-0708-05	169.99	<b>GV-282</b>
		7" x 1" x 7/8"	Offset	T	Green	SVS, SVS-2	Goodson Spec	89.99	<b>GV-282A</b>
		8" x 1 3/8" x 7/8"	Offset	GP	Gray	VL	010-0819-04	97.99	<b>GV-260</b>
Stem	3" x 1 1/4" x 5/8"	Cup	GP	Gray	All but VL	010-0300-05	21.29	<b>GV-237</b>	
		Cup	CB	Blue	All but VL	Goodson Spec	25.99	<b>GV-237-CB</b>	

Colors may vary due to manufacturing processes. All valve refacing wheels are guaranteed for 1 year from original purchase date.



### Mineral Based Valve Grinding Oil

- Long-lasting • Cools while grinding
- Removes particles for a better finish
- Inhibits rust • Prevents rancidity, foaming & deposits

Quantity	Jobber	Order No.
1 gallon / 3.79 L	\$ 29.99	<b>VGO-10</b>
5 gallons / 18.93 L	119.99	<b>VGO-50</b>



### Valve Grinding Aid For Titanium, Stainless & Stellite Valves

- Not water soluble - add to your mineral based Valve Grinding Oil for better finish on titanium, stainless steel and stellite valves
- Mix ratio: 1:4 • Won't hinder your regular valve grinding process
- Seeks out, and bonds to hot metals
- Ideal for grinding hard metal racing valves • 32 oz. / 946 mL
- Order No. **VGA-T32** Jobber \$42.99



### Severe Duty Valve Refacer Oil

- Mineral Based
- Formulated for titanium, Inconel®, stainless steel and stellite valves
- Includes additives to improve cutting performance under high pressure

Size	Jobber	Order No.
1 Gal.	\$ 34.99	<b>VGO-SD10</b>
5 Gal.	174.99	<b>VGO-SD50</b>

CYLINDER HEAD REBUILDING  
CLEANING, ASSEMBLY & SAFETY  
SHORT BLOCK REBUILDING  
CRANKSHAFT/ FLYWHEEL GRINDING  
MISCELLANEOUS TOOLS & SUPPLIES  
BRAKE & TIRE CHANGING TOOLS  
MEASURING TOOLS  
V-TWIN & METRIC HARD PARTS



Choose the correct profile for your machine and application

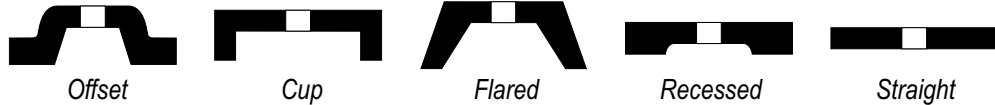

Colors may vary due to manufacturing processes. All valve refacing wheels are guaranteed for 1 year from original purchase date.

To Fit	Use	Dia x Ht x Arb	Shape	Type	Color	Fits Models	OE No.	Jobber	Order No.
KO Lee	Valve	5" x 3/4" x 5/8"	Offset	GP	Gray	All models	OV5GH60	\$ 77.99	GV-658
		5" x 3/4" x 5/8"	Offset	S	White	All models	OV5GH80S	52.99	GV-659
	Stem	4" x 1" x 5/8"	Cup	GP	Gray	K500(C) & K403(C)	RV4KH60	27.99	GV-345
		4" x 1" x 5/8"	Cup	CB	Blue	All but 500 & CRW	Goodson Spec	31.79	GV-345-CB
Rottler	Valve	7" x 1" x 7/8"	Offset	GP	Gray		VTRW-8	59.99	GV-280
VR-7		7" x 1" x 7/8"	Offset	T	Green		VTRW-7	169.99	GV-282
	Stem	3" x 1 1/4" x 5/8"	Cup	GP	Gray		VTRW-9	21.29	GV-237
Rottler	Valve	8" x 1 1/4" x 1 1/2"	Flared	GP	Gray		Goodson Spec	169.99	GV-525
		8" x 1 1/4" x 1 1/2"	Flared	T	Gray		Goodson Spec	99.99	GV-527
VR-8		100 x 50 x 20mm	Cup	GP	White	VR416, RV-516	7606	54.79	GV-928
Skil	Valve	5" x 3/4" x 5/8"	Offset	GP	Gray	All models	7556/VW80	77.99	GV-658
		5" x 3/4" x 5/8"	Offset	S	White	All models	VW80S	52.99	GV-659
Snap-On	Stem	4" x 1" x 5/8"	Cup	GP	Gray	All but Skil 491	7557/VR2M89	27.99	GV-345
		4" x 1" x 5/8"	Cup	CB	Blue	All but 500 & CRW	Goodson Spec	31.79	GV-345-CB
Sioux™	Valve	4" x 1" x 5/8"	Offset	CB	Blue	All but 680, 682, 285, 956	Goodson Spec	31.79	GV-146-CB
		4" x 1" x 5/8"	Offset	GP	Gray	All but 680, 682, 285, 956	78SP	31.99	GV-147
		4" x 1" x 5/8"	Offset	GP	Black	All but 680, 682, 285, 956	78E	52.99	GV-148
		4" x 1" x 5/8"	Offset	S	Gray	All but 680, 682, 285, 956	78A	37.29	GV-149
		4" x 1" x 5/8"	Offset	S	Ruby	All but 680, 682, 285, 956	Goodson Spec	29.99	GV-144
		4" x 1" x 5/8"	Offset	T	Green	All but 680, 682, 285, 956	Goodson Spec	47.99	GV-150
		5" x 1" x 5/8"	Offset/20°	GP	Pink	Thor 299 & 300	Goodson Spec	44.99	GV-156
		6" x 5/8" x 3/4"	Offset	S	White	685L	186	79.99	GV-186
		7" x 1 1/16" x 1 3/4"	Str./15°	GP	Orange	680, 956, 2001 & 2075	176	54.49	GV-270
		7" x 1 1/16" x 1 3/4"	Str./15°	CB	Blue	680, 956, 2001 & 2075	Goodson Spec	49.99	GV-270-CB
	Stem	4" x 1" x 5/8"	Cup	GP	Gray	All but 682 & 685	81 (73533)	27.99	GV-345
		4" x 1" x 5/8"	Cup	CB	Blue	All but 500 & CRW	Goodson Spec	31.79	GV-345-CB
Sunnen	Valve	6" x 1 1/16" x 3/4"	Flared	GP	Black	VR6500, all S&D	VR602	137.99	GV-766
(TA) S&D	Stem	5" x 1 1/2" x 3/4"	Cup	GP	White	VR6500, all S&D	VR601	74.99	GV-755
Winona	Valve	5" x 3/4" x 5/8"	Off./Bev.	GP	Gray	E, Y, VW, X, XA	75399	77.99	GV-658
Van		5" x 3/4" x 5/8"	Off./Bev.	S	White	K500HM, K403CM	75400	52.99	GV-659
Norman	Stem	12" x 5/8" x 3"	Straight	GP	Gray	CRW, VR-1000	802003/24078	97.99	GV-409
		12" x 5/8" x 3"	Str./15°	S	Ruby	VR-1000	805667	134.99	GV-410
	Stem	4" x 1" x 5/8"	Cup	GP	Gray	All but 500 & CRW	40352	27.99	GV-345
		4" x 1" x 5/8"	Cup	CB	Blue	All but 500 & CRW	Goodson Spec	31.79	GV-345-CB
		10" x 1 1/4" x 3"	Recessed	GP	Gray	CRW	24079	134.99	GV-408

Colors may vary due to manufacturing processes. All valve refacing wheels are guaranteed for 1 year from original purchase date.

Use VG-STOP for extra long stemmed valves



### Adaptor for 1/2" Chucks

- For small diameter valves
- Hardened steel collet holder fits any machine with a 1/2" chuck • Collet seats in retainer nut for fast, easy removal
- Internal stop adjusts with a screwdriver, allowing you to reface an entire set of valves to identical specs quickly
- 4 collet sizes cover range of 4.0 - 6.5mm
- Start with the set then replace collets as needed (collets will not work without the holder) • Use the Adaptor Stop to machine longer valve stems

Description	Range	Jobber	Order No.	Incl.
Full Set		\$269.99	UVRC-46	✓
Steel Collet Holder (collets MUST be used)		199.99	UVRC-46R	x
Replacement	4.0mm (.157")	37.49	UVRC-4MM	x
Collets	4.5 - 5.0 mm (.177"-.196")	37.49	UVRC-5MM	x
	5.0 - 5.5 mm (.196"-.216")	37.49	UVRC-5.5MM	x
	6.0 - 6.5 mm (.236"-.256")	37.49	UVRC-6.5MM	x
Adaptor Stop		13.99	VG-STOP	x

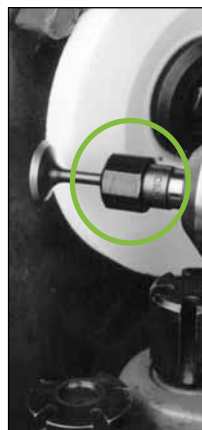

### Valve Stem to Valve Face Concentricity Gauge

- Accurate to .001"
- Features a rugged, positive stop – set it once and do an entire set of valves • Use before grinding to eliminate needless cleaning & machine time • Use after refacing to ensure stem concentricity • Also check pilots and other small parts for concentricity
- For stems as small as 4mm
- Order No. VCG-16 Jobber \$224.99



CYLINDER HEAD REBUILDING  
CLEANING, ASSEMBLY & SAFETY  
SHORT BLOCK REBUILDING  
CRANKSHAFT/ FLYWHEEL GRINDING  
MISCELLANEOUS TOOLS & SUPPLIES  
BRAKE & TIRE CHANGING TOOLS  
MEASURING TOOLS  
V-TWIN & METRIC HARD PARTS



"At Goodson, we're trained to know your business. Weekly training sessions are held for our entire staff to help us better understand your work so we can provide you with the best possible service."

- Anne, Goodson Accounting Department - 11 years of service

# Piloted Core Drills and Reamers

• CNC-machined to .0003" T.I.R. or less • Ideal for any Bridgeport-type (collet driven) machine • Use dry at 175 to 225 RPM

## Piloted Core Drills

- Center accurately in the guide • Cutting angle prevents the bit from wandering due to irregular guide wear • Flutes are designed to enlarge bores quickly • Manufactured to close tolerances of concentricity

## Precision Reamers

- Pilot size is carefully matched to the OD of the corresponding core drill • Assures accurate location of the reamer for smooth, vibration free operation • Gives proper interference fit to match manufacturer specifications

### Core Drills

### Core Reamers

	OD	Pilot	Orig. No.	Jobber	Order No.	OD	Orig. No.	Jobber	Order No.
<b>DCM Tech,</b>	.4687"	.312"	DP-1550	\$ 99.99	<b>DPP-1511B</b>	.500"	66-02147, RR-115	\$ 99.99	<b>DRR-115</b>
<b>Peterson /</b>	.4687"	.344"	66-02138, DP-1511	99.99	<b>DPP-1511</b>	.500"	66-02147, RR-115	99.99	<b>DRR-115</b>
<b>Kansas</b>	.4687"	.375"	66-02140, DP-1530	99.99	<b>DPP-1530</b>	.500"	66-02147, RR-115	99.99	<b>DRR-115</b>
<b>Instruments</b>	.5312"	.375"	DP-1730	99.99	<b>DPP-1530A</b>	.5625"	66-02148, RR-916	99.99	<b>DRR-916</b>
½" Round	.5937"	.375"	66-02144, DP-1930	109.99	<b>DPP-1970B</b>	.625"	66-02149, RR-519	99.99	<b>DRR-519</b>
Shank	.5937"	.438"	66-02145, DP-1970	99.99	<b>DPP-1970</b>	.625"	66-02149, RR-519	99.99	<b>DRR-519</b>
<b>Sunnen™ /</b>	.490"	.312"	VGS-156A	99.99	<b>DTA-2082B</b>	.500"	VGS-162A	99.99	<b>DRT-2097</b>
<b>Tobin-Arp</b>	.490"	.343"	VGS-152A	99.99	<b>DTA-2082</b>	.500"	VGS-162A	99.99	<b>DRT-2097</b>
½" with Flat	.490"	.371"	VGS-153A	99.99	<b>DTA-2083</b>	.500"	VGS-162A	99.99	<b>DRT-2097</b>
<b>Winona</b>	.4687"	.344"	804206	99.99	<b>DD-1532-G</b>	.500"	804237	99.99	<b>DR-500-G</b>
<b>Van Norman</b>	.4687"	.375"	804207	99.99	<b>DD-1532A-G</b>	.500"	804237	99.99	<b>DR-500-G</b>
<b>IDL /</b>	.475"	.341"	501003	99.99	<b>DVN-2</b>	.500"	501011	99.99	<b>DRV-79</b>
<b>Van Norman</b>	.475"	.341"	501003	99.99	<b>DVN-2</b>	.500"	501011	99.99	<b>DRV-79</b>
5/16" Sq. Drive									
<b>Universal</b>	.429"	7mm		155.49	<b>CCD-59</b>	.4365"	Use for FORD 6.0L Diesel	129.99	<b>FCR-60-1</b>
.429" Round	.429"	7mm		155.49	<b>CCD-59</b>	.4375"	Use for FORD 6.0L Diesel	129.99	<b>FCR-60</b>
Shank	.429"	7mm		155.49	<b>CCD-59</b>	.4995"	Use for Cummins Diesel	155.49	<b>CCR-59</b>
						.562"	.500" pilot	155.49	<b>CCR-562B</b>
	.541"	8mm		155.49	<b>CCD-550</b>	.550	.540" pilot	155.49	<b>CCR-550</b>

Note: For the best performance, Core Drills and Reamers should be used in matched pairs. If you order a drill slightly smaller or larger than the OE specification to fit your machine, please order the matching reamer listed immediately to the right of the drill in the table.

CYLINDER HEAD REBUILDING  
CLEANING, ASSEMBLY & SAFETY  
CRAN FLYWHEELS  
MISCELLANEOUS TOOLS & SUPPLIES  
BRAKE & TIRE CHANGING TOOLS  
MEASURING TOOLS  
V-TWIN & METRIC HARD PARTS



## High Speed Steel Core Drill/Reamers

- Save time – drill and ream in a single pass
- Top-quality, high speed steel
- Prepares the guide bore for standard OD valve guide inserts
- Several shank designs to fit most Seat & Guide machines

Fits	Size	mm	Jobber	Order No.
Winona Van Norman	.343" x .500"	8.7x12.7	\$179.99	<b>CDR-6055G</b>
.468" flat	.375" x .500"	9.5x12.7	179.99	<b>CDR-6056G</b>
Tobin-Arp & Sunnen	.343" x .500"	8.7x12.7	179.99	<b>CDR-6105G</b>
Peterson and K.I.	.343" x .500"	8.7x12.7	179.99	<b>CDR-6196G</b>
½" round shank	.375" x .500"	9.5x12.7	179.99	<b>CDR-6197G</b>
Kwik-Way and DCM	.343" x .500"	8.7x12.7	179.99	<b>CDR-6211G</b>
½" round shank	.375" x .500"	9.5x12.7	179.99	<b>CDR-6212G</b>
IDL 5/16" square w/.500"	.343" x .500"	8.7x12.7	179.99	<b>CDR-6762G</b>
Serdi	.275" x .437"	7.0x11.1	179.99	<b>CDR-7192G</b>
¾" with flat	.275" x .500"	7.0x12.7	179.99	<b>CDR-7193G</b>
	.312" x .437"	7.9x11.1	179.99	<b>CDR-7194G</b>
	.312" x .500"	7.9x12.7	179.99	<b>CDR-7195G</b>
	.343" x .500"	8.7x12.7	179.99	<b>CDR-7196G</b>
	.375" x .500"	9.5x12.7	179.99	<b>CDR-7197G</b>
<b>Cobalt Core Drills/ Reamers</b>	<b>Size</b>	<b>mm</b>	<b>Jobber</b>	<b>Order No.</b>
½" round shank	.312" x .500"	7.9x12.7	\$179.99	<b>CDR-312-CB</b>
	.343" x .500"	8.71x12.7	179.99	<b>CDR-343-CB</b>
	.375" x .500"	9.53x12.7	179.99	<b>CDR-375-CB</b>
	.275" x .437"	7.00x11.1	179.99	<b>CDR-274-CB</b>
	.275" x .500"	7.00x12.7	179.99	<b>CDR-275-CB</b>
	.373" x .625"	9.47x16.5	179.99	<b>CDR-625-CB</b>

**new**

Tools and **tech tips** from the techxperts™

For best results, limit speed to 175 RPM

## Check these other tools for diesel applications

Air Powered Valve Guide Drivers .....	page 30
Valve Guides .....	page 30
Valve Seals .....	page 35
Pneumatic Valve Spring Compressor .....	page 36
Heat Tabs .....	page 52

sized for **diesel**

## Valve Guide Tooling For 24 Valve, 7mm Cummins

- To replace integral guides used in this diesel cylinder head
- Replacement guides are .502/.511" stepped to use with OE or replacement seals below

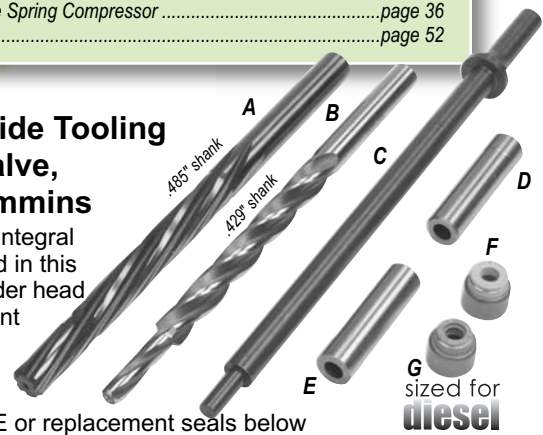

Description	Jobber	Order No.	Includes
<b>Complete Kit</b>	\$399.99	<b>CVG-KIT</b>	▼
<b>Tooling Kit Only</b>	299.99	<b>CVG-59KIT</b>	▼
<b>A</b> Core Reamer (.426" pilot, .485" shank)	155.49	<b>CCR-59</b>	1 1
<b>B</b> Core Drill (7mm pilot, .429" shank)	155.49	<b>CCD-59</b>	1 1
<b>C</b> Guide Driver (7.0mm)	22.99	<b>PHL-2235-G</b>	1 1
<b>D</b> Cast Iron Valve Guide (Exhaust)	3.29	<b>CIG-3022</b>	12
<b>E</b> Cast Iron Valve Guide (Intake)	3.29	<b>CIG-3021</b>	12
<b>F</b> Exhaust Seals (12 pk.)	13.99	<b>CVS-59E</b>	1
<b>G</b> Intake Seals (12 pk.)	13.99	<b>CVS-59I</b>	1

### tech tips

from the techxperts™  
Use WSR-41-3-G (1/4" sq.) or WSR-41-4-G (3/8" sq.) with WSR-41-7-G (3/8" drill adaptor). Clamp 3/8" drive in drill to drive reamers directly. See page 34 for ordering information.

## Small Reamers for Cast Iron or Bronze

Premium quality reamers with tough cobalt flutes for long life in cast iron or bronze. Once used on cast iron, do **NOT** use on bronze

### 1/8" Square Drive

Inch	mm	Order No.
.1565"	3.98	MR-156
.1575"	4.00	MR-4MM
.1585"	4.03	MR-158
.1760"	4.47	MR-176
.1771"	4.50	MR-4.5MM
.1780"	4.52	MR-178
.1960"	4.98	MR-196
.1968"	5.00	MR-5.0MM
.1980"	5.03	MR-198

Jobber \$74.99

## Titanium Coated Cobalt Reamers

- Smooth and precise
- Less brittle than carbide
- For cast iron
- **Not for hardened or bronze guides**

### 3/16" Square Drive

Inch	mm	Order No.
.2165"	5.50	TNR-5.5MM-B
.236"	6.00	TNR-6MM-B
.248"	6.30	TNR-248-B
.250"	6.35	TNR-250-B
.2755"	7.00	TNR-7MM-B

### 1/4" Square Drive

Inch	mm	Order No.
.312"	7.92	TNR-312-B
.315"	8.00	TNR-8MM-B
.340"	8.64	TNR-340-B
.341"	8.66	TNR-341-B
.342"	8.69	TNR-342-B
.343"	8.71	TNR-343-B
.344"	8.74	TNR-344-B
.354"	9.00	TNR-9MM-B
.373"	9.47	TNR-373-B
.374"	9.50	TNR-374-B
.375"	9.52	TNR-375-B
.376"	9.55	TNR-376-B
.377"	9.58	TNR-377-B
.378"	9.60	TNR-378-B

Jobber \$82.99

**tech tips** For best results always use these reamers with Bronze Reaming Oil (BW-303A-G)  
from the techxperts™

## Solid Carbide Valve Guide Reamers Specifically Designed For Use Only With Bronze Guides

- Features an extended pilot and multi-fluted design so you can size guides perfectly • One size allows you to fit both intake & exhaust when using AV&V valves and guides
- 300 to 400 RPM is recommended.
- **DO NOT** use on cast iron

Dia.	Jobber	Order No.	Dia.	Jobber	Order No.
4.0mm	\$189.99	HGR-4.0MM	.3140"	\$269.99	HGR-3140
4.5mm	189.99	HGR-4.5MM	8.0mm	269.99	HGR-8MM
5.0mm	189.99	HGR-5.0MM	.3160"	269.99	HGR-3160
5.5mm	189.99	HGR-5.5MM	.3410"	269.99	HGR-3410
6.0mm	269.99	HGR-6MM	.3420"	269.99	HGR-3420
6.5mm	269.99	HGR-6.5MM	.3425"	269.99	HGR-3425
6.6mm	269.99	HGR-6.6MM	.3430"	269.99	HGR-3430
7.0mm	269.99	HGR-7MM	.3435"	269.99	HGR-3435
.2750"	269.99	HGR-2750	.3440"	269.99	HGR-3440
.2761"	269.99	HGR-2761	.3450"	269.99	HGR-3450
.2766"	269.99	HGR-2766	9.0mm	269.99	HGR-9MM
.3100"	269.99	HGR-3100	.3720"	269.99	HGR-3720
.3110"	269.99	HGR-3110	.3730"	269.99	HGR-3730
.3115"	269.99	HGR-3115	.3740"	269.99	HGR-3740
.3120"	269.99	HGR-3120	.3750"	269.99	HGR-3750
.3130"	269.99	HGR-3130	.3777"	269.99	HGR-3777
			.3782"	269.99	HGR-3782

Due to the characteristics of carbide, we can only guarantee the reamer's dimensional accuracy.

## High Speed Finish Reamers Exclusively for Cast Iron

Precision size cast iron guides. Piloted and made from the finest tempered steel. With proper care, these reamers will accurately size multiple guides without losing their efficient cutting action. Not for hardened or bronze guides.

### 3/16" Square Drive

Inch	mm	Jobber	Order No.
.2165"	5.50	\$41.99	WR-5.5MM-G
.217"	5.51	41.99	WR-217-G
.218"	5.54	41.99	WR-218-G
.236"	6.00	41.99	WR-6MM-G
.250"	6.35	41.99	WR-250-G
.256"	6.50	41.99	WR-6.5MM-G
.257"	6.53	41.99	WR-257-G
.258"	6.55	41.99	WR-258-G
.259"	6.58	41.99	WR-259-G
.260"	6.60	41.99	WR-260-G
.261"	6.63	41.99	WR-261-G
.273"	6.93	41.99	WR-273-G
.274"	6.96	41.99	WR-274-G
.275"	6.99	41.99	WR-275-G
.2755"	7.00	41.99	WR-7MM-G
.276"	7.01	41.99	WR-276-G
.277"	7.03	41.99	WR-277-G
.278"	7.06	44.99	WR-278-G
.279"	7.09	44.99	WR-279-G
.281"	7.14	44.99	WR-281-G

### 1/4" Square Drive

Inch	mm	Jobber	Order No.
.310"	7.87	\$44.99	WR-310-G
.311"	7.90	44.99	WR-311-G
.312"	7.92	44.99	WR-312-G
.313"	7.95	44.99	WR-313-G
.314"	7.98	44.99	WR-314-G

### 1/4" Square Drive

Inch	mm	Jobber	Order No.
.315"	8.00	\$44.99	WR-8MM-G
.316"	8.03	44.99	WR-316-G
.317"	8.05	44.99	WR-317-G
.318"	8.08	44.99	WR-318-G
.327"	8.31	44.99	WR-327-G
.328"	8.33	44.99	WR-328-G
.334"	8.48	44.99	WR-8.5MM-G
.340"	8.64	44.99	WR-340-G
.341"	8.66	44.99	WR-341-G
.342"	8.69	44.99	WR-342-G
.343"	8.71	44.99	WR-343-G
.3435"	8.72	44.99	WR-3435-G
.344"	8.74	44.99	WR-344-G
.345"	8.76	44.99	WR-345-G
.346"	8.79	44.99	WR-346-G
.347"	8.81	44.99	WR-347-G
.348"	8.84	44.99	WR-348-G
.353"	8.97	44.99	WR-353-G
.354"	9.00	44.99	WR-9MM-G
.355"	9.02	44.99	WR-355-G
.356"	9.04	44.99	WR-356-G
.358"	9.09	47.99	WR-358-G
.371"	9.42	47.99	WR-371-G
.372"	9.45	47.99	WR-372-G
.373"	9.47	47.99	WR-373-G
.374"	9.50	47.99	WR-374-G

### 1/4" Square Drive

Inch	mm	Jobber	Order No.
.375"	9.52	\$47.99	WR-375-G
.376"	9.55	47.99	WR-376-G
.377"	9.58	47.99	WR-377-G
.378"	9.60	47.99	WR-378-G
.379"	9.63	47.99	WR-379-G
.380"	9.65	47.99	WR-380-G
.386"	9.84	47.99	WR-386-G
.388"	9.86	47.99	WR-388-G
.390"	9.91	47.99	WR-390-G
.393"	9.98	47.99	WR-393-G
.394"	10.00	47.99	WR-10MM-G
.395"	10.03	47.99	WR-395-G
.404"	10.26	49.99	WR-404-G
.405"	10.29	49.99	WR-405-G
.406"	10.31	52.99	WR-406-G
.433"	11.00	52.99	WR-11MM-G
.435"	11.05	52.99	WR-435-G
.436"	11.07	52.99	WR-436-G
.437"	11.10	52.99	WR-437-G
.453"	11.51	52.99	WR-453-G
.472"	12.00	52.99	WR-12MM-G
.496"	12.60	54.99	WR-496-G
.499"	12.67	54.99	WR-499-G
.500"	12.70	54.99	WR-500-G
.502"	12.75	54.99	WR-502-G

CYLINDER HEAD REBUILDING  
CLEANING, ASSEMBLY & SAFETY  
SHORT BLOCK REBUILDING  
FLYWHEEL GRINDING  
CRANKSHAFT/ TOOLS & SUPPLIES  
MISCELLANEOUS  
BRAKE & TIRE CHANGING TOOLS  
MEASURING TOOLS  
V-TWIN & METRIC HARD PARTS

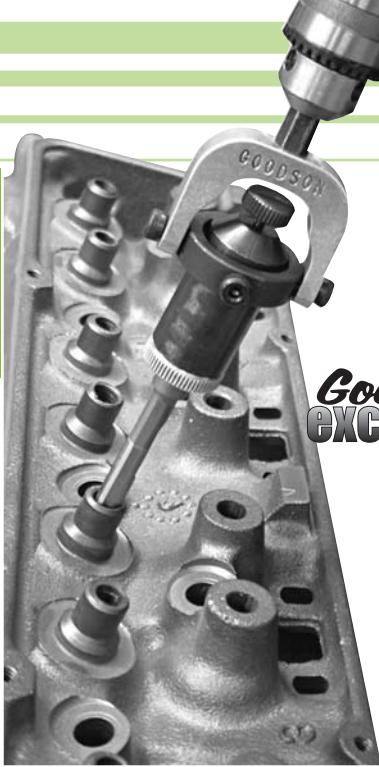

**Goodson**  
exclusive



No more guesswork!  
Easy to read and easy to use  
feed knob. Each witness mark  
equals approximately .001"  
increase in hone diameter.

- Largest range of any guide hone
- Diamond abrasive delivers the finish required for today's valve guides
- Balanced yoke and body for symmetrical honing at any speed
- Size range replaces over 80 reamers!

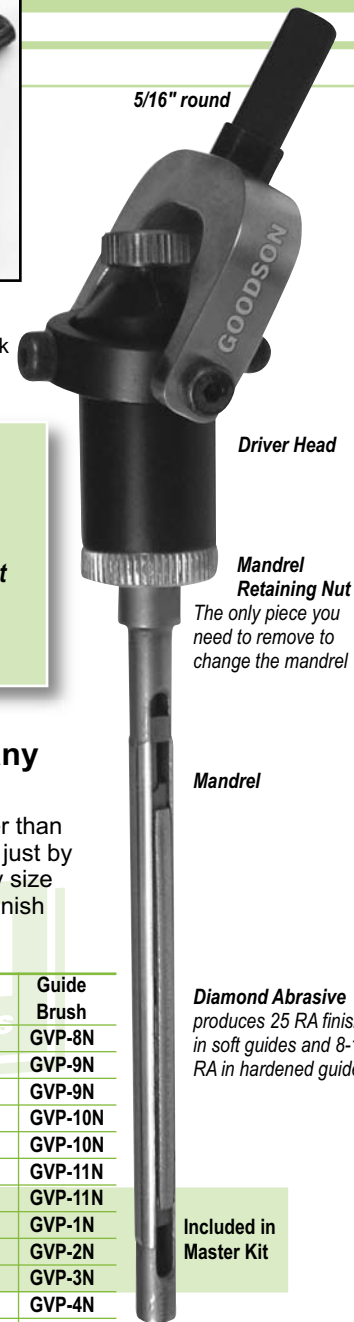

5/16" round

Driver Head

Mandrel  
Retaining Nut

The only piece you  
need to remove to  
change the mandrel

Mandrel

Diamond Abrasive  
produces 25 RA finish  
in soft guides and 8-10  
RA in hardened guides

Included in  
Master Kit

## Hyper-Finish Diamond Sizing System has the largest range of any guide hone on the market today

Goodson's exclusive Hyper-Finish Diamond Valve Guide Sizing System is bigger and better than ever. With this easy-to-use system you can size guides from .154" to .566" (3.9 - 14.40mm) just by switching out mandrels. Mandrels also sold individually. The Drive Head (**HF-100**) fits every size mandrel assembly shown in the chart below and features a Quick Change set-up. Hyper-Finish Tooling is NOT interchangeable with Sunnen® (p. 28).

Size	Range		Mandrel Assembly (abrasive & mandrel)	Abrasive Length	Abrasive Only	Mandrel Only	Drive Head	Guide Brush
	inch	mm						
4.0mm	.154"-.164"	3.90 - 4.15mm	\$299.99 HFM-154C	20mm	HFS-154	HFM-154	HF-100	GVP-8N
4.5mm	.173"-.183"	4.40 - 4.90mm	299.99 HFM-173C	20mm	HFS-173	HFM-173	HF-100	GVP-9N
5.0mm	.193"-.203"	4.90 - 5.15mm	299.99 HFM-193C	40mm	HFS-193	HFM-193	HF-100	GVP-9N
5.5mm	.212"-.232"	5.40 - 5.90mm	299.99 HFM-212C	40mm	HFS-212	HFM-212	HF-100	GVP-10N
6.0mm	.232"-.253"	5.90 - 6.40mm	299.99 HFM-232C	40mm	HFS-232	HFM-232	HF-100	GVP-10N
6.5mm	.251"-.271"	6.40 - 6.90mm	299.99 HFM-251C	40mm	HFS-251	HFM-251	HF-100	GVP-11N
7.0mm	.271"-.311"	6.90 - 7.90mm	349.99 HFM-271C	80mm	HFS-271	HFM-271	HF-100	GVP-11N
5/16"	.307"-.347"	7.80 - 8.80mm	299.99 HFM-307C	80mm	HFS-307	HFM-307	HF-100	GVP-1N
11/32"	.334"-.374"	8.50 - 9.50mm	299.99 HFM-344C	80mm	HFS-344	HFM-344	HF-100	GVP-2N
3/8"	.350"-.389"	8.90 - 9.90mm	299.99 HFM-350C	80mm	HFS-350	HFM-350	HF-100	GVP-3N
10.0mm	.389"-.429"	9.90 - 10.90mm	299.99 HFM-394C	80mm	HFS-394	HFM-394	HF-100	GVP-4N
11.0mm	.429"-.507"	10.90 - 12.90mm	299.99 HFM-429C	80mm	HFS-429	HFM-429	HF-100	GVP-5N
12.5mm	.488"-.566"	12.40 - 14.40mm	499.99 HFM-488C	80mm	—	—	HF-100	GVP-6N
			Jobber		\$149.99	\$199.99	\$329.99	\$6.79

## Choose from the Standard Master Kit or Build Your Own!

**Standard Master Kit includes:** Driver Head, 4-Mandrel Assemblies (see chart above), 4-Nylon Valve Guide Brushes (7mm to 3/8") and 8 oz. Diamond Honing Oil. Order No. **HF-KIT** Jobber \$1,399.99

**Custom Kit includes:** Driver Head, 4-Mandrel Assemblies (select from chart above, **excluding 12.5mm**), 4-Nylon Valve Guide Brushes (you pick the sizes - see chart above) and 8 oz. Diamond Honing Oil. Order No. **HF-KIT-CUSTOM** Jobber \$1,399.99



### Diamond Honing Oil

For high pressure honing

Size	Jobber	Order No.
8 oz.	\$ 5.29	DHO-8
1 Gallon	38.99	DHO-10
5 Gallons	174.99	DHO-50

Weather-proof electrical box with switch and outlet to power your electric drill or other tooling



Adjustable hose lets you direct coolant to right where you need it

1 1/2" diameter holes and 2-1" diameter holes drilled in the top plate provide ample tool storage

## Hyper-Finish Honing Station

You asked for it and Goodson delivered!

This Goodson designed honing station incorporates the features you requested in a benchtop honing station including:

- Large 5-gallon capacity coolant sump
- Integral high output pump - 1/150 HP oil filled submersible pump, 115V 60 cycle, single phase heavy-duty motor
- Built-in 115V adjustable worklight
- All aluminum construction for durability and easy cleaning
- Perforated steel grate allows used coolant through to recirculate
- Removeable steel grate for easy maintenance
- Built-in, easy-to-reach storage for tools

Buy the complete kit and save!

**American Made**

Description	Jobber	Order No.	Incl.
Complete 110V Honing Station Kit	\$1,039.99	HF-1000KIT	
Complete 220V Honing Station Kit	1,099.99	HF-1000E-KIT	
Honing Station Only - 110V	739.99	HF-1000	x
Honing Station Only - 220V	799.99	HF-1000E	x
Universal Head Holders	119.99	HH-200	x x
Replacement Pump	139.99	HF-PUMP	x x
5 Gallons Diamond Honing Oil	174.99	DHO-50	x x

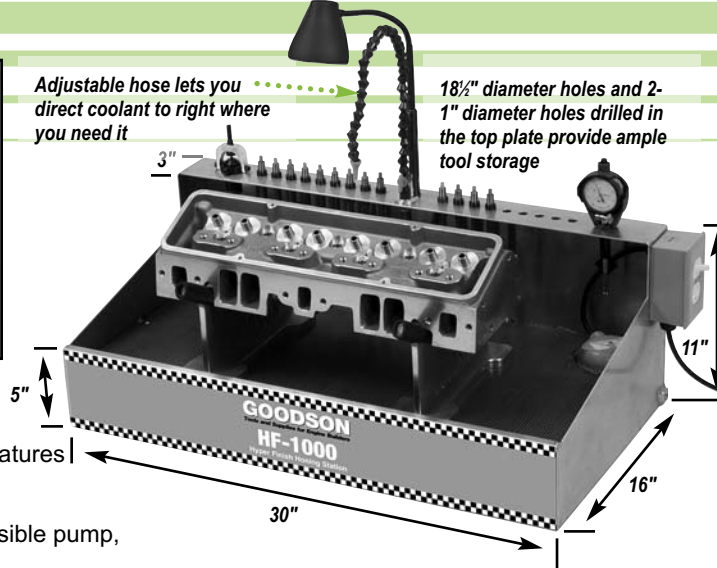

Perforated steel grate lets coolant through and can be removed for cleaning

On/Off Switch activates the built-in pump and worklight

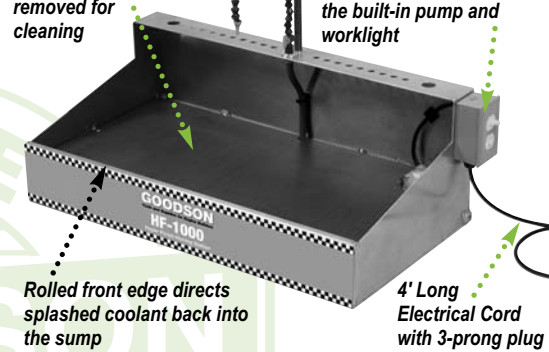

Rolled front edge directs splashed coolant back into the sump

4' Long Electrical Cord with 3-prong plug

## Valve Guide OD Machining Tool

Does 3 jobs at one time!

- Face the guide top to the correct size • Sizes the guide OD for press-on seals • Chamfers the top to prevent seal damage • Cutters & pilots are interchangeable and chuck into any portable drill, drill press or seat & guide machine

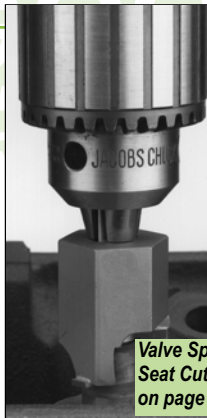

Valve Spring Seat Cutters on page 40



## Valve Guide OD Chamfer Tool

- Improve oil deflection
- Universal cutter chamfers any OD from 1/4" to 5/8" (6.35-15.9mm)
- Most precise when used in a Seat and Guide Machine
- Order No. **GCT-35**  
Jobber \$79.99



### Individual Cutters

Guide OD	Order No.
.415"	10.5 <b>VSC-415</b>
.428"	10.8 <b>VSC-428</b>
.475"	12.1 <b>VSC-475</b>
.495"	12.6 <b>VSC-495</b>
.500"	12.7 <b>VSC-500</b>
.530"	13.5 <b>VSC-530</b>
.562"	14.3 <b>VSC-562</b>
.625"	15.9 <b>VSC-625</b>

Jobber \$71.99

### Pilots

Guide ID	Order No.
3/32"	7.0 <b>VP-7MM</b>
5/16"	7.9 <b>VP-312</b>
1/32"	8.7 <b>VP-343</b>
3/8"	9.5 <b>VP-375</b>

Jobber \$27.99

### Cutter and Pilot Assemblies

Guide OD	Pilot Size	Order No.
.415"	10.5 5/16" 7.9	<b>VSC-415312</b>
.428"	10.9 5/16" 7.9	<b>VSC-428312</b>
.475"	12.1 9/32" 7.0	<b>VSC-475275</b>
.475"	12.1 5/16" 7.9	<b>VSC-475312</b>
.495"	12.6 1/32" 8.7	<b>VSC-495343</b>
.500"	12.7 5/16" 7.9	<b>VSC-500312</b>
.500"	12.7 1/32" 8.7	<b>VSC-500343</b>
.500"	12.7 3/8" 9.5	<b>VSC-500375</b>
.530"	13.5 5/16" 7.9	<b>VSC-530312</b>
.530"	13.5 1/32" 8.7	<b>VSC-530343</b>
.530"	13.5 3/8" 9.5	<b>VSC-530375</b>
.562"	14.3 5/16" 7.9	<b>VSC-562312</b>
.562"	14.3 1/32" 8.7	<b>VSC-562343</b>
.562"	14.3 3/8" 9.5	<b>VSC-562375</b>
.625"	15.9 3/8" 9.5	<b>VSC-625375</b>

Jobber \$89.99



## Valve Guide Top Collar

- Supports guide top during machining
- Protects against damage or breakage
- Ideal for high-performance work, and for installing Bronze-Wall® guide inserts or thin-wall liners

Size	Range	Jobber	Order No.
.500"	.496" -.504"	\$8.99	<b>VGC-502</b>
.530"	.526" -.534"	8.99	<b>VGC-530</b>
.566"	.562" -.570"	8.99	<b>VGC-566</b>



CYLINDER HEAD REBUILDING  
CLEANING, REBUILDING & SAFETY  
SHORT BLOCK REBUILDING  
FLYWHEEL GRINDING  
CRANKSHAFT/GRINDING  
MISCELLANEOUS TOOLS & SUPPLIES  
BRAKE & TIRE CHANGING TOOLS  
MEASURING TOOLS  
V-TWIN & METRIC HARD PARTS



"If any of our products aren't satisfactory, we want you to send it back...we have a no hassle return policy. Just send it back, freight pre-paid within 30 days and we'll exchange it, fix it or credit your account for the amount of the purchase."

- Nancy, Warehouse Manager, 20 years of service



### Valve Guide Hone Set

- Sets-up fast • Easy to use! • Produces straight, round holes for top-quality work • Ideal for high-performance applications
- Use a low RPM, 1/2" drill for driving power (200 RPM max.)
- Sunnen® tooling is NOT interchangeable with Godson Hyper-Finish (page 26)

Description	Jobber	Order No.
Sunnen Honall® Valve Guide Hone Set	\$734.99	P-190
Includes: Head & Driver. Mandrels & Sleeves (1 of ea. for sizes - 5/16", 11/32", 3/8", & 7/16")		
Adaptors: (1) PK10-A & (1) PK12-A. Stones L10-J69 & L12-J67. Case & instructions		
Sunnen Honall® Valve Guide Hone Head & Driver only	\$314.99	P-180

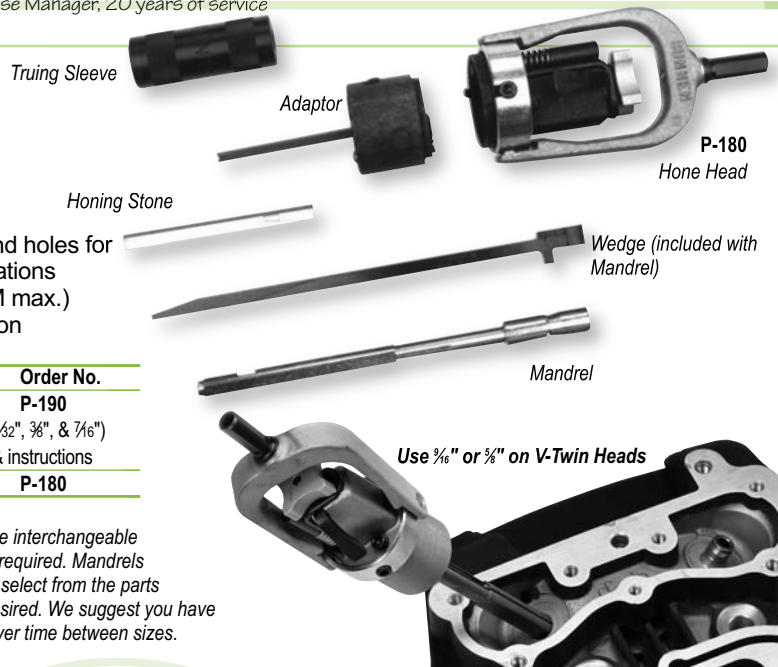

Use 5/8" or 3/8" on V-Twin Heads

**Ordering Information:** The head and driver are interchangeable with the adaptors. Only one head and driver is required. Mandrels are available to cover all popular sizes. Please select from the parts in the photo above and order per size range desired. We suggest you have an adaptor for each mandrel to save change-over time between sizes.

### tech tips

from the techexperts™

Size	Range		Mandrel		Sleeve		Roughing Stones		Finishing Stones		Adaptor		Stone Retainer	
	Inch	mm	Jobber	Order No.	Jobber	Order No.	Jobber	Order No.	Jobber	Order No.	Jobber	Order No.	Jobber	Order No.
3/16"	.185"-.190"	4.7-4.8	\$39.99	BL6-185CS	\$ 9.29	S-185	\$59.99	L6-J47 (12)	\$59.99	L6-J67 (12)	\$69.99	PSK6-A*	\$10.29	LN-3087C
	.190"-.195"	4.8-4.9	39.99	BL6-190CS	9.29	S-190	59.99	L6-J47 (12)	59.99	L6-J67 (12)	69.99	PSK6-A*	10.29	LN-3087C
5mm	.195"-.200"	4.9-5.1	39.99	BL6-195CS	9.29	S-195	59.99	L6-J47 (12)	59.99	L6-J67 (12)	69.99	PSK6-A*	10.29	LN-3087C
	.200"-.205"	5.1-5.2	39.99	BL6-200CS	9.29	S-200	59.99	L6-J47 (12)	59.99	L6-J67 (12)	69.99	PSK6-A*	10.29	LN-3087C
	.205"-.210"	5.2-5.3	39.99	BL6-205CS	9.29	S-205	59.99	L6-J47 (12)	59.99	L6-J67 (12)	69.99	PSK6-A*	10.29	LN-3087C
5.5mm	.210"-.215"	5.3-5.5	39.99	BL6-210CS	9.29	S-210	59.99	L6-J47 (12)	59.99	L6-J67 (12)	69.99	PSK6-A*	10.29	LN-3087C
	.215"-.220"	5.5-5.6	39.99	BL6-215CS	9.29	S-215	59.99	L6-J47 (12)	59.99	L6-J67 (12)	69.99	PSK6-A*	10.29	LN-3087C
	.225"-.230"	5.7-5.8	39.99	BL6-225CS	9.29	S-225	59.99	L6-J47 (12)	59.99	L6-J67 (12)	69.99	PSK6-A*	10.29	LN-3087C
6mm	.230"-.235"	5.8-6.0	39.99	BL6-230CS	9.29	S-230	59.99	L6-J47 (12)	59.99	L6-J67 (12)	69.99	PSK6-A*	10.29	LN-3087C
	.235"-.240"	6.0-6.1	39.99	BL6-235CS	9.29	S-235	59.99	L6-J47 (12)	59.99	L6-J67 (12)	69.99	PSK6-A*	10.29	LN-3087C
	.240"-.245"	6.1-6.2	39.99	BL6-240CS	9.29	S-240	59.99	L6-J47 (12)	59.99	L6-J67 (12)	69.99	PSK6-A*	10.29	LN-3087C
1/4"	.245"-.250"	6.2-6.4	39.99	BL8-245AS	9.29	S-245	35.99	L8-J47 (6)	35.99	L8-J67 (6)	70.99	PK8-A	---	---
	.250"-.255"	6.4-6.5	39.99	BL8-250AS	9.29	S-250	35.99	L8-J47 (6)	35.99	L8-J67 (6)	70.99	PK8-A	---	---
6.6mm	.255"-.260"	6.5-6.6	39.99	BL8-255AS	9.29	S-255	35.99	L8-J47 (6)	35.99	L8-J67 (6)	70.99	PK8-A	---	---
7mm	.270"-.275"	6.8-7.0	39.99	BL8-270AS	9.29	S-270	35.99	L8-J47 (6)	35.99	L8-J67 (6)	70.99	PK8-A	---	---
	.275"-.280"	7.0-7.1	39.99	BL8-275AS	9.29	S-275	35.99	L8-J47 (6)	35.99	L8-J67 (6)	70.99	PK8-A	---	---
✓ 5/16"	.308"-.316"	7.8-8.0	41.99	BL10-308AS	9.29	S-308	40.99	L10-J47 (6)	40.99	L10-J69 (6)	70.99	PK10-A	---	---
✓ 11/32"	.339"-.347"	8.6-8.8	41.99	BL10-339AS	9.29	S-339	40.99	L10-J47 (6)	40.99	L10-J69 (6)	70.99	PK10-A	---	---
23/64"	.354"-.362"	9.0-9.2	41.99	BL10-354AS	9.29	S-354	40.99	L10-J47 (6)	40.99	L10-J69 (6)	70.99	PK10-A	---	---
✓ 3/8"	.370"-.385"	9.4-9.8	44.29	BL12-370AS	13.29	S-370	40.99	L12-J47 (6)	40.99	L12-J67 (6)	70.99	PK12-A	---	---
✓ 7/16"	.432"-.447"	11.0-11.4	44.29	BL12-432AS	13.29	S-432	40.99	L12-J47 (6)	40.99	L12-J67 (6)	70.99	PK12-A	---	---
9/16"	.557"-.588"	14.1-14.9	54.99	BL16-557AS	15.79	S-557	46.29	L16-J47 (6)	46.29	L16-J67 (6)	70.99	PK16-A	---	---
5/8"	.619"-.650"	15.7-16.5	66.29	BL20-619AS	15.79	S-619	47.99	L20-J47 (6)	47.99	L20-J67 (6)	70.99	PAK20-A	---	---

9/16" & 5/8" Ideal for V-Twin

✓ Included in set \*NOTE: Remove the stone retainer included with the PSK6-A and replace with LN-3087C for valve guide honing

### Ultra-Finish Plateau Soft Honers

- Use AFTER guide honing to remove microscopic peaks and cuffs without enlarging the guide ID
- Abrasive impregnated nylon bristles

Hole Diameter	Hone Head	Overall	Jobber	Order No.
in	mm	Dia. Length		
.2187"	5.5	.241" 1.00"	\$ 9.79	UF-5.5MM
.2500"	6.4	.275" 1.25"	9.79	UF-6.4MM
.2813"	7.0	.309" 1.25"	10.99	UF-7MM
.3125"	8.0	.343" 1.25"	10.99	UF-8MM
.3437"	9.0	.378" 1.25"	10.99	UF-9MM
.3750"	10.0	.413" 1.25"	10.99	UF-10MM
.4375"	11.0	.481" 1.25"	10.99	UF-11MM
.4688"	12.0	.516" 1.25"	10.99	UF-12MM
.5000"	13.0	.550" 1.50"	12.29	UF-13MM



### 6 Piece Valve Guide Flex-Hone® Set

- Kit includes the most popular sizes for valve guide work
- 240 Grit Silicon-Carbide

Size	mm	OAL	Jobber	Order No.	Incl.
6 Pc. Valve Guide Kit			\$84.99	VGf-KIT	▼
1/4"	6.4	8"	\$20.99	VGf-6.4MM	x
9/32"	7.0	8"	20.99	VGf-7MM	x
5/16"	8.0	8"	20.99	VGf-8MM	x
11/32"	9.0	8"	20.99	VGf-9MM	x
3/8"	10.0	8"	20.99	VGf-10MM	x
7/16"	11.0	8"	20.99	VGf-11MM	x

More Valve Guide Flex-Hones® on page 72

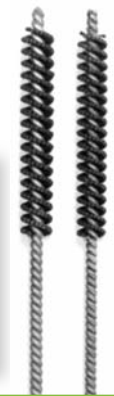

CYLINDER HEAD REBUILDING  
CLEANING, ASSEMBLY & SAFETY  
SHORT BLOCK REBUILDING  
CRANKSHAFT/ FLYWHEEL GRINDING  
MISCELLANEOUS TOOLS & SUPPLIES  
BRAKE & TIRE CHANGING TOOLS  
MEASURING TOOLS  
V-TWIN & METRIC HARD PARTS

1° negative angle prevents guides from spreading

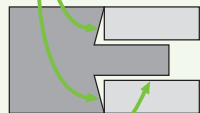

Proper clearance for best contact and easy removal

# Valve Guide Replacement

## Valve Guide Drivers

- Corrosion-resistant finish
- Rockwell hardness of 45-50
- Pilots are slightly smaller than guide ID for easy removal



Powered Drivers				
Standard Sizes		Jobber	Order No.	Incl.
<b>4-piece Kit</b>		\$62.99	PH-2226-G	▼
Guide ID /mm	Driver OD	Pilot		
.312" / 7.92	.487" / 12.4	.300" / 7.62	\$19.99	PH-2228A-G
.312" / 7.92	.423" / 10.7	.304" / 7.72	19.99	PH-2228-G
.343" / 8.71	.487" / 12.4	.337" / 8.56	19.99	PH-2229-G
.372" / 9.47	.487" / 12.4	.367" / 9.32	19.99	PH-2231-G
.437" / 11.10	.612" / 15.5	.429" / 10.90	19.99	PH-2230-G
Metric Sizes		Jobber	Order No.	Incl.
<b>6-piece Kit</b>		\$89.99	PH-2600-G	▼
Guide ID /in.	Driver OD	Pilot		
5.0mm / .196"	9.0 / .355"	4.75 / .187"	\$19.99	PH-2250-G
5.5mm / .217"	10.5 / .412"	5.21 / .205"	19.99	PH-2255-G
6.0mm / .236"	10.5 / .412"	5.72 / .225"	19.99	PH-2260-G
6.6mm / .260"	11.8 / .463"	6.30 / .248"	19.99	PH-2234-G
7.0mm / .275"	11.0 / .432"	6.60 / .260"	19.99	PH-2235-G
8.0mm / .315"	11.7 / .462"	7.80 / .307"	19.99	PH-2236-G
9.0mm / .353"	12.4 / .487"	8.81 / .347"	19.99	PH-2237-G
10mm / .393"	15.5 / .612"	8.56 / .387"	19.99	PH-2238-G
11mm / .433"	15.5 / .612"	10.85 / .427"	19.99	PH-2239-G

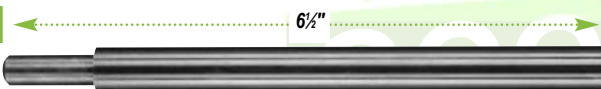

Manual Drivers				
Standard Sizes		Jobber	Order No.	Incl.
<b>4-piece Kit</b>		\$58.99	GP-500A-G	▼
Guide ID /mm	Driver OD	Pilot		
.312" / 7.92	.422" / 10.7	.305" / 7.75	\$18.99	GP-431-G
.312" / 7.92	.487" / 12.4	.302" / 7.67	18.99	GP-531-G
.343" / 8.71	.487" / 12.4	.336" / 8.53	18.99	GP-534-G
.372" / 9.47	.487" / 12.4	.367" / 9.32	18.99	GP-537-G
.437" / 11.10	.611" / 15.5	.428" / 10.87	18.99	GP-743-G
Metric Sizes		Jobber	Order No.	Incl.
<b>6-piece Kit</b>		\$79.99	GP-600M-G	▼
Guide ID /in.	Driver OD	Pilot		
6.6mm / .260"	11.7 / .462"	6.22 / .245"	\$18.99	GP-6.6MM-G
7mm / .275"	10.7 / .422"	6.78 / .267"	18.99	GP-7MM-G
8mm / .315"	12.3 / .485"	7.77 / .306"	18.99	GP-8MM-G
9mm / .353"	12.3 / .485"	8.84 / .348"	18.99	GP-9MM-G
10mm / .393"	15.5 / .611"	9.80 / .386"	18.99	GP-10MM-G
11mm / .433"	15.5 / .611"	10.82 / .426"	18.99	GP-11MM-G



## Minnesota Fast Freeze instantly chills seats and guides to -50°F / -45.5°C

- Creates interference fit with heated aluminum heads • Finish seat and guide work faster than ever • Aerosol\*
- Use on tight bushings, pins, shafts, etc.
- Order No. MFF-8 Jobber \$29.99

Buy 6 or more cans MFF-8 and save 10% off jobber

\*Hazardous Goods Fees Apply When Shipped by Air



## Extra-Long Valve Guide Drivers

- For use with overhead cam heads
- 1° negative angle to prevent guide mushrooming • Pilots are slightly smaller than guide ID • 7.5" long

Guide ID /in	Driver OD	Pilot	Jobber	Order No.
4.0mm / .157"	9.0 / .355"	3.80 / .150"	\$22.99	PHL-2240-G
4.5mm / .177"	9.0 / .355"	4.30 / .170"	22.99	PHL-2245-G
5.0mm / .196"	9.0 / .355"	4.75 / .187"	22.99	PHL-2250-G
5.5mm / .217"	10.5 / .412"	5.21 / .205"	22.99	PHL-2255-G
6.0mm / .230"	9.1 / .358"	5.72 / .225"	22.99	PHL-2258-G
6.0mm / .236"	10.5 / .412"	5.72 / .225"	22.99	PHL-2260-G
6.6mm / .260"	11.8 / .463"	6.29 / .248"	22.99	PHL-2234-G
7.0mm / .275"	11.0 / .432"	6.60 / .260"	22.99	PHL-2235-G
7.9mm / .313"	10.7 / .423"	7.72 / .304"	22.99	PHL-2228-G
8.0mm / .315"	11.7 / .462"	7.80 / .307"	22.99	PHL-2236-G
8.7mm / .343"	12.4 / .487"	8.56 / .337"	22.99	PHL-2229-G
9.5mm / .375"	12.4 / .487"	9.32 / .367"	22.99	PHL-2231-G

## Air-Powered Valve Guide Drivers for Diesel Engines

- Drive guides in from the shoulder instead of from the top
- Installing drivers have the proper recess to drive guides in for the correct installed height
- Remove / install guides faster – no measuring necessary
- For most standard pneumatic tools



Application	Installer Major/ Counter Bore ID	Order No.	Remover Shank/Pilot OD	Order No.
Cummins	.752" / .503"	DVG-Ci	.595" / .450"	DVG-CR
Cummins 8.3. 6CT	.552" / —	DVG-8.3	.491" / .304"	DVG-71R
Caterpillar 3116	.515" / .475"	DVG-3116	.491" / .304"	DVG-71R
Caterpillar 3126	.633" / .506"	DVG-3126	.595" / .354"	DVG-3468R
Caterpillar 3306	.660" / —	DVG-3306	.595" / .354"	DVG-3468R
Caterpillar 3406-3408	.709" / —	DVG-3468i	.595" / .354"	DVG-3468R
Caterpillar 3406-3408B	.632" / —	DVG-3468Bi	.595" / .354"	DVG-3468R
Detroit GMC 53	.502" / .421"	DVG-53i	.491" / .246"	DVG-53R
Detroit GMC 71/92	.502" / .435"	DVG-71i	.491" / .304"	DVG-71R
International DT 466	.640" / .440"	DVG-466i	.595" / .354"	DVG-3468R
Mack	.675" / —	DVG-Mi	.620" / .484"	DVG-MR
Mack 4	.689" / .678"	DVG-M4	.595" / .354"	DVG-3468R

Jobber \$29.99

Jobber \$29.99



## Air Hammer

- Prevents guide damage
- Delivers 3500 blows per minute
- Weighs 3 lbs.
- .401" tool opening

Description	Jobber	Order No.
Air Hammer	\$74.99	AH-335
Replacement Retainer Spring	8.99	AH-5RS

## Universal Driver Tool

- Sized to extend Diesel Guide Drivers above
- .401" ID
- Order No. CL-7333 Jobber \$37.49





"We take our job of getting your order to you quickly very seriously. We use several different carriers allowing us to get your products to you when you need them at a price you can afford."

- Becky, Shipping Department, 1 year of service

CYLINDER HEAD REBUILDING  
CLEANING, ASSEMBLY & SAFETY  
SHORT BLOCK REBUILDING  
CRANKSHAFT/ FLYWHEEL GRINDING  
MISCELLANEOUS TOOLS & SUPPLIES  
BRAKE & TIRE CHANGING TOOLS  
MEASURING TOOLS  
V-TWIN & METRIC HARD PARTS

## Adjustable Powered Valve Guide Driver With Replaceable Pilots

- Standardize the correct installed height on one guide then repeat it on all others
- Screw-in pilots with 5/16" - 18 threads
- 6 1/2" overall length

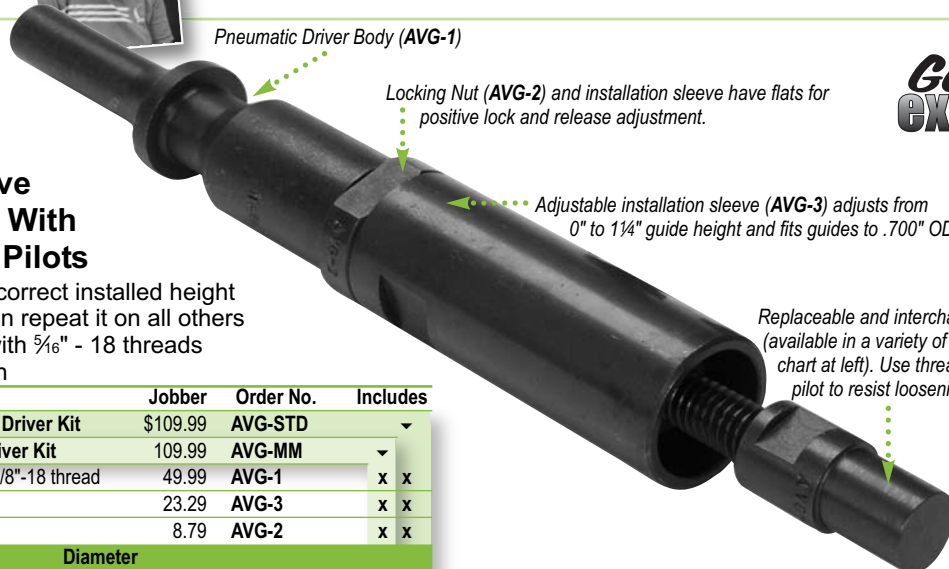

Pneumatic Driver Body (AVG-1)

Locking Nut (AVG-2) and installation sleeve have flats for positive lock and release adjustment.

Adjustable installation sleeve (AVG-3) adjusts from 0" to 1 1/4" guide height and fits guides to .700" OD.

Replaceable and interchangeable pilot (available in a variety of sizes, see chart at left). Use thread locker on pilot to resist loosening while in use.

**Goodson  
exclusive**

Description	Jobber	Order No.	Includes
Standard Valve Guide Driver Kit	\$109.99	AVG-STD	
Metric Valve Guide Driver Kit	109.99	AVG-MM	
Pneumatic Body Only 5/8"-18 thread	49.99	AVG-1	x x
Installation Sleeve	23.29	AVG-3	x x
Locking Nut	8.79	AVG-2	x x
<b>Replaceable Pilots</b>			
	<b>Diameter</b>		
	.312"	AVG-312	x
	.343"	AVG-343	x
	.372"	AVG-372	x
	.437"	AVG-437	x
	5.0mm	AVG-5MM	x
	5.5mm	AVG-55MM	
	6.0mm	AVG-6MM	x
	6.6mm	AVG-66MM	
	7.0mm	AVG-7MM	x
	8.0mm	AVG-8MM	x
	9.0mm	AVG-9MM	
Harley-Davidson® Adaptor (see right)	49.99	AVG-HD-KIT	



Due to the nature of these pilots, they cannot be warranted against breakage, but are guaranteed to be dimensionally correct.

## Harley-Davidson® Adaptor Kit

- Replaces standard screw-in pilot with longer "Harley" pilot. Cap then fits over the top of the guide to drive on the shoulder
- Eliminates guide mushroaming
- 5/16" - 18 Threads
- Order No. **AVG-HD-KIT** Jobber \$49.99



**The more you buy, the more you save!**  
Buy 50 - 100 guides, save 10% off jobber.  
Buy 100+ guides, save 20% off jobber (mix & match sizes)



More valve guides on pages 127 and 131



## Cast Iron False Valve Guides

ID	OD	Length	Jobber	Order No.
.312"	.439"	2.281"	\$2.99	CIG-312
.342"	.502"	3.062"	2.99	CIG-342
.372"	.502"	2.750"	2.99	CIG-372
.343"	.564"	2.750"	3.29	OG-343
.373"	.564"	2.750"	3.29	OG-373

### 24 Valve 7mm Cummins Diesel (.511" seal surface) see tooling, page 24

ID	OD	Length	Jobber	Order No.
Intake .275"	.502"	1.940"	\$3.29	CIG-3021
Exhaust .275"	.502"	2.020"	3.29	CIG-3022

**Ford 6.0L (.513" x 659" seal surface) see tooling, page 24**

ID	OD	Length	Jobber	Order No.
.275"	.4395"	2.332"	\$2.99	CIG-3055

## Manganese Bronze False Valve Guides

ID	OD	Length	Jobber	Order No.
.250"	.283"	1.250"	\$7.49	BVG-283-125
.311"	.439"	3.062"	4.79	BVG-311
.343"	.502"	2.375"	4.79	BVG-343
.372"	.502"	2.375"	4.79	BVG-372



**The more you buy, the more you save!**  
Buy 10 or more and save 10% off jobber



## Universal Repair Guides

- Unfinished ID ready to be reamed with AV&V's exclusive carbide reamers (p. 25)
- Manganese bronze

ID	OD	Length	Jobber	Order No.
4.5mm	.620"	2.000"	\$9.49	UVBG-4.5MM
5.0mm	.620"	2.000"	9.49	UVBG-5MM
5.5mm	.620"	2.225"	9.49	UVBG-5.5MM
6.0mm	.620"	2.375"	9.49	UVBG-6MM
7.0mm	.740"	2.700"	8.99	UVBG-7MM
.308"	.740"	2.700"	8.99	UVBG-308
.372"	.740"	2.700"	8.99	UVBG-372

## Press Fit Lube

- Ideal for valve guides, piston pins, cylinder sleeves and more
- Eliminates gouging and galling of parts during press fit operation
- Aerosol\*
- Order No. **PFL-200** Jobber \$11.99



**Buy 12 or more and SAVE 10% off Jobber**



\*Hazardous Goods Fees Apply When Shipped Air





**Goodson**  
EXCLUSIVE

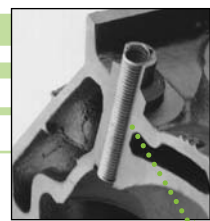

### Bronze-Wall® Bushings

- Spiral inserts rebuild cast-iron guides worn .030"
- Highly durable Phosphor-Bronze
- Thread easily into tapped bore
- Helps guides and stems last longer
- .038" wire for reamed guides

Size	Qty.	Jobber	Order No.
<b>Standard Bushings</b>			
5/16"	50	\$73.49	BW-010B-G
1/2"	50	73.49	BW-020B-G
3/8"	50	73.49	BW-050B-G

**The more you buy, the more you save ...**  
2-4 boxes of bushings, save 10% off jobber,  
5 or more boxes, save 20% off jobber



### Bronze-Wall® 2 Bushings

- Spiral inserts rebuild cast-iron guides worn .030"
- Highly durable Phosphor-Bronze
- Thread easily into tapped bore
- Helps guides and stems last longer
- .035" wire for broached guides • Easy to install and size using Sizing Ball and Driver instead of Broach and Reamer

Size	Qty.	Jobber	Order No.
<b>Standard Bushings</b>			
5/16"	50	\$73.49	BW2B-312
1/2"	50	73.49	BW2B-343
3/8"	50	73.49	BW2B-375

Bronze bushings thread easily into tapped bores. Replace guides at any time by simply uncoiling the old ones.



### Bronze-Wall® Broach

- Use with Bronze-Wall® Bushings only
- Pre-sizes the bushing for finish reaming • Use with Bronze Reaming Oil (p. 34)

Size	Jobber	Order No.
5/16"	\$50.29	BW-606-G
1/2"	50.29	BW-626-G
3/8"	50.29	BW-646-G

### Bronze-Wall® Reamers

- Left hand rotation
- Use for final sizing

ID	Size	Order No.
5/16"	.3125"	BW-602-G
1/2"	.3407"	BW-622-3-G
	.3417"	BW-622-2-G
	.3427"	BW-622-1-G
	.3437"	BW-622-G
3/8"	.3450"	BW-622A-G
	.3725"	BW-682-G
	.3740"	BW-642-1-G
	.3750"	BW-642-G
Jobber		\$134.99



### Bronze-Wall® 2 Sizing Balls & Driver

- Use with Bronze-Wall® 2 bushings instead of broach and reamers for finish sizing

ID	Size	Jobber	Order No.
5/16"	.312"	\$19.99	CL-5312
1/2"	.343"	19.99	CL-5343
	.373"	19.99	CL-5373
3/8"	.374"	19.99	CL-5374
	Sizing Ball Driver	84.99	CL-4444P

More Sizing Balls are listed on page 33

Buy 3 or more sizing balls (any combination) and save 10% off jobber



## Use Tooling Below With Both Bronze-Wall® & Bronze-Wall® 2 Bushings

### Bronze-Wall® & Bronze-Wall® 2 Tap Tool

- Three sizes to choose from
- Use to remove existing valve guide from the guide bore
- Use with either Bronze-Wall® or Bronze-Wall® 2 Bushings

ID	Size	Jobber	Order No.
5/16"		\$157.49	BW-601-G
1/2"		125.99	BW-621-G
3/8"		155.49	BW-641-G
1/2" Tap Drive Adaptor for 1/2" Drill		45.29	BW-442-G



### Bronze-Wall® & Bronze-Wall® 2 Insert Tool

- Several sizes to choose from
- Use to install Bronze-Wall® bushings into tapped guide bore

Bushing Size	Jobber	Order No.
5/16"	\$84.49	BW-603-G
1/2"	84.49	BW-623-G
3/8"	84.49	BW-643-G

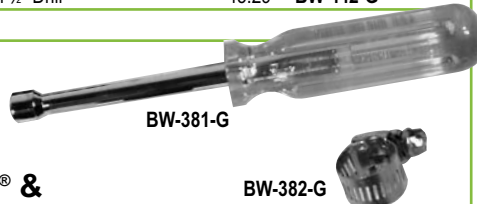

### Bronze-Wall® & Bronze-Wall® 2 Bushing Retainers

- Use with either Bronze-Wall® or Bronze-Wall® 2 Bushings
- Prevents bushings from moving while sizing with reamer or sizing balls

Description	Jobber	Order No.
Bushing Retainer Clamp	\$ 4.79	BW-382-G
Bushing Retainer Clamp Driver	15.29	BW-381-G

### Bronze-Wall® & Bronze-Wall® 2 Cut-Off Tool

- Use to trim the bushing to final length once it has been finish sized
- Use with both Bronze-Wall® and Bronze-Wall® 2 Bushings

ID	Size	Jobber	Order No.
5/16"		\$68.29	BW-471-G
1/2"		81.99	BW-473-G
3/8"		68.29	BW-476-G

Optional Accessories		
Universal Drive Adaptor	\$37.49	CL-7333
Valve Guide Cleaning Brush	3.29	WCB-44

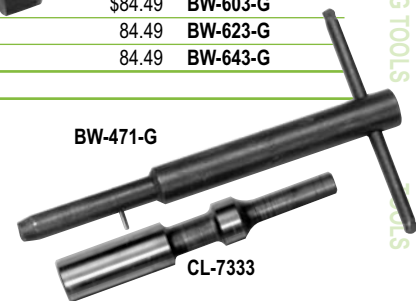

CYLINDER HEAD REBUILDING  
CLEANING, ASSEMBLY & SAFETY  
SHORT BLOCK REBUILDING  
FLYWHEEL GRINDING  
CRANKSHAFT/ FLYWHEEL GRINDING  
MISCELLANEOUS TOOLS & SUPPLIES  
BRAKE & TIRE CHANGING TOOLS  
MEASURING TOOLS  
V-TWIN & METRIC HARD PARTS



"Did you know that Goodson still ships orders COD? If you prefer not to use a credit card or set up an open account, you can still order from Goodson. Ask us about COD."

- Pam, Accounting/Purchasing Department, 13 years of service

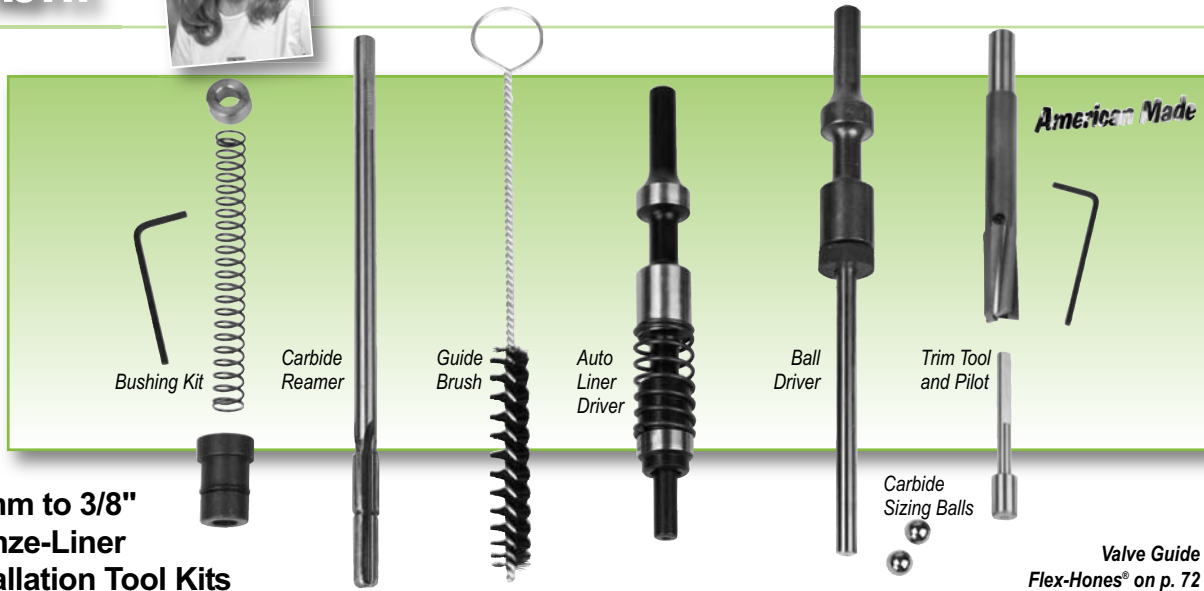

**5.0mm to 3/8"  
Bronze-Liner  
Installation Tool Kits**

Phosphor-Bronze is an ideal valve guide material – it's more durable than cast iron, conducts heat away faster and retains lubrication better to reduce wear. Install rugged, thin-wall (.030") Bronze-Liners in cast iron or aluminum heads to repair guides and deliver performance better than new! Plus, Bronze-Liners install quickly with simple tools. If a Bronze-Liner ever wears out, you can quickly and easily replace it with a new one to restore performance. **Removal Tools, page 33.**

Valve Guide  
Flex-Hones® on p. 72

Kits include ▼	5.0mm Guides*		5.5mm Guides*		6.0mm Guides		6.6mm Guides		7.0mm Guides	
Master Tool Kits	\$549.99	CL-5MM	\$499.99	CL-5.5MM	\$419.99	CL-6MM	\$419.99	CL-6.6MM	\$419.99	CL-7MM
Carbide Reamer	169.99	CL-2028C	169.99	CL-2026C	127.79	CL-2024C	127.79	CL-2006C	127.79	CL-2007C
Bushing Kit	54.99	CL-2004	42.99	CL-2002	42.99	CL-2003	42.99	CL-2001	42.99	CL-2001
Ball Driver	84.99	CL-4454P	84.99	CL-4452P	84.99	CL-4452P	84.99	CL-4446P	84.99	CL-4446P
Carbide Sizing	19.99	.1965" CL-51965	19.99	.2175" CL-52175	19.99	.237" CL-5237	19.99	.261" CL-5261	19.99	.277" CL-5277
Balls	19.99	.197" CL-5197	19.99	.218" CL-5218	19.99	.238" CL-5238	19.99	.262" CL-5262	19.99	.278" CL-5278
Auto-Driver	119.99	CL-3610	119.99	CL-3600	119.99	CL-3600	119.99	CL-3566	119.99	CL-3507
Trim Tool	67.99	CL-5602	67.99	CL-5602	67.99	CL-5602	67.99	CL-5602	67.99	CL-5600
Trim Tool Pilot	25.99	CL-5636	25.99	CL-5634	25.99	CL-5634	25.99	CL-5626	25.99	CL-5626
Guide Brush	6.79	GVP-9N	6.79	GVP-10N	6.79	GVP-10N	6.79	GVP-10N	3.29	WCB-44

\* 5.0mm and 5.5mm guides require our tooling, see page 33 for tech tip

**Kits Require Seat Centering Cones - See Chart Below**

Kits include ▼	5/16" Guides		8.0mm Guides		11/32" Guides		9.0mm Guides		3/8" Guides	
Master Tool Kits	\$399.99	CL-312	\$419.99	CL-8MM	\$399.99	CL-343	\$499.99	CL-9MM	\$399.99	CL-375
Carbide Reamer	127.79	CL-2005C	127.79	CL-2008C	127.79	CL-2012C	169.99	CL-2018C	127.79	CL-2014C
Bushing Kit	42.99	CL-2000	42.99	CL-2000	42.99	CL-2000	42.99	CL-2000	42.99	CL-2000
Ball Driver	84.99	CL-4444P	84.99	CL-4444P	84.99	CL-4444P	84.99	CL-4444P	84.99	CL-4444P
Carbide Sizing	19.99	.3125" CL-53125	19.99	.316" CL-5316	19.99	.344" CL-5344	19.99	.355" CL-5355	19.99	.375" CL-5375
Balls	19.99	.313" CL-5313	19.99	.317" CL-5317	19.99	.3445" CL-53445	19.99	.356" CL-5356	19.99	.376" CL-5376
Auto-Driver	119.99	CL-3500	119.99	CL-3500	119.99	CL-3504	119.99	CL-3512	119.99	CL-3506
Trim Tool	67.99	CL-5600	67.99	CL-5600	67.99	CL-5600	67.99	CL-5600	67.99	CL-5600
Trim Tool Pilot	25.99	CL-5620	25.99	CL-5620	25.99	CL-5622	25.99	CL-5630	25.99	CL-5624
Guide Brush	3.29	WCB-44	3.29	WCB-44	3.29	WCB-44	3.29	WCB-44	3.29	WCB-44

**60° Seat  
Centering  
Cones**

- Center firmly in the valve seat
- Cones feature a .625" ID
- Steel construction
- Use the Seat Centering Cones with the Master Tool Kits (above) for proper alignment of the reamer and guide bore



Description	Jobber	Order No.	
7 pc. Kit	\$199.99	CL-6500	▼
Nominal	Range		
1"	0.970"-0.730"	\$37.99	CL-6310 x
1¼"	1.230"-0.740"	37.99	CL-6308 x
1½"	1.475"-0.805"	37.99	CL-6306 x
1¾"	1.730"-0.860"	37.99	CL-6304 x
2"	1.950"-0.875"	37.99	CL-6302 x
2¼"	2.230"-1.000"	37.99	CL-6300 x
2½"	2.550"-1.875"	37.99	CL-6312 x

**tech tips**  
from the techxperts!

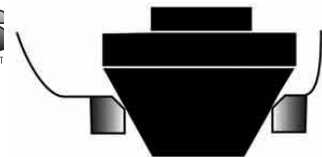

The centering cone must fit the valve seat properly so using the correct size is essential. This is NOT a one-size-fits-all tool. If you have a cone that is too small for the seat it could slip through the opening. If you have one that's too large, the side of the combustion chamber could interfere or you won't have enough of the cone in the seat area for it to be stable and centered.

# Bronze-Liners & Tooling

Buy 3 or more sizing balls (any combination) and save 10% off jobber

## Carbide Sizing Balls

- Finished to .00008" roundness
- Within the 90 Rockwell range
- The finished ID of the Bronze-Liner will be .001" smaller than the ball used

Size	Order No.
5.0mm	.196" CL-5196
	.1965" CL-51965
	.197" CL-5197
5.5mm	.2165" CL-52165
	.2175" CL-52175
	.218" CL-5218
6.0mm	.236" CL-5236
	.237" CL-5237
	.238" CL-5238
6.6mm	.260" CL-5260
	.261" CL-5261
	.262" CL-5262
7.0mm	.276" CL-5276
	.277" CL-5277
	.278" CL-5278
5/16"	.312" CL-5312
	.3125" CL-53125
	.313" CL-5313
	.314" CL-5314

Jobber \$19.99

Size	Order No.
8.0mm	.315" CL-5315
	.316" CL-5316
	.317" CL-5317
1 1/32"	.343" CL-5343
	.3435" CL-53435
	.344" CL-5344
	.3445" CL-53445
	.345" CL-5345
	.346" CL-5346
9.0mm	.354" CL-5354
	.355" CL-5355
	.356" CL-5356
3/8"	.373" CL-5373
	.374" CL-5374
	.3745" CL-53745
	.375" CL-5375
	.3755" CL-53755
	.376" CL-5376

Jobber \$19.99



Phosphor-Bronze liners outlast original guides and are easy to replace

## Thin-Wall .030" Bronze-Liners

- Outlast original guides
- Cross-hatch promotes oil retention
- Rounded nose design makes installation quick and easy
- Stripe helps you identify rounded end
- Phosphor-bronze

**tech tips**  
from the TechExperts™

NOTE: 5.0 & 5.5mm Guides do NOT interchange with competitors' guides. You MUST use our tooling with these guides.

Guide Size	OD	Length	Box of 16		Box of 100	
			Jobber	Order No.	Jobber	Order No.
5.0mm	+ .030"	2.00"	\$19.99	CL-500	\$74.99	CL-500A
5.5mm	+ .030"	2.50"	19.99	CL-550	74.99	CL-550A
6.0mm	+ .030"	2.50"	19.99	CL-600	74.99	CL-600A
6.6mm	+ .030"	2.50"	19.99	CL-660	74.99	CL-660A
7.0mm	+ .030"	2.50"	19.99	CL-700	74.99	CL-700A
.312"	+ .030"	2.50"	19.99	CL-1220	74.99	CL-1220A
8.0mm	+ .030"	2.50"	19.99	CL-1420	74.99	CL-1420A
.343"	+ .030"	3.00"	19.99	CL-1640	74.99	CL-1640A
9.0mm	+ .030"	2.50"	19.99	CL-1690	74.99	CL-1690A
.375"	+ .030"	3.00"	19.99	CL-1830	74.99	CL-1830A
<b>Override Bronze Liners</b>						
.343" +.002"	+ .032"	3.00"	\$19.99	CL-1640-2	\$83.99	CL-1640-2A
.375" +.002"	+ .032"	3.00"	19.99	CL-1820-2	83.99	CL-1820-2A



Stripe helps you quickly identify the round nose end  
Rounded nose design makes installation fast and easy

## Removal Tool

Remove bronze liners without damaging the bore

Description	Jobber	Order No.
5.0mm	\$54.99	CL-7356
5.5mm	54.99	CL-7354
6.0mm	54.99	CL-7352
6.6mm	54.99	CL-7342
7.0mm	54.99	CL-7344
5/16"	54.99	CL-7310
8.0mm	54.99	CL-7320
1 1/32"	54.99	CL-7330
9.0mm	54.99	CL-7348
3/8"	54.99	CL-7340

## Universal Driver Tool

- Fits all removal tools at left and is designed to work with your air hammer
- .401" ID
- Order No. **CL-7333**

Jobber \$37.49



## Chamfer Tool & T-Wrench

Use these optional accessories to remove any burrs that may be created when trimming the liner to length

Description	Jobber	Order No.
Chamfer Tool	\$25.99	CL-5800
T-Wrench	25.99	CL-5870

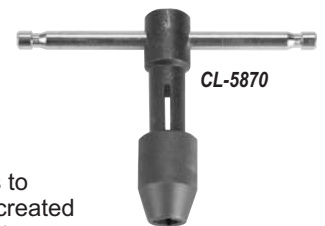

CL-5870



CL-5800

## Mitutoyo

### Small Hole Gauge Set

- See if rebuilding or replacing is needed by checking actual guide wear
- Check guide bosses for proper interference fit during replacement
- Check and maintain correct stem-to-guide ID clearance
- 4-piece set has combined range of .125" to .500"
- With storage pouch
- Order No. **SHG-5** Jobber \$129.99



## Mitutoyo

### Split Ball Bore Gauge

- Dial gauge with large contact area
- Measures quickly & accurately to .0001" (.0025mm)
- Works in threaded or knurled guide IDs
- Range: .280"-.400"
- Easy to change contacts
- Includes molded plastic storage case
- Order No. **MVG-34** Jobber \$599.99



CYLINDER HEAD REBUILDING

CLEANING, ASSEMBLY & SAFETY

SHORT BLOCK REBUILDING

FLYWHEEL GRINDING

MISCELLANEOUS TOOLS & SUPPLIES

BRAKE & TIRE CHANGING TOOLS

MEASURING TOOLS

V-TWIN & METRIC HARD PARTS



"We want every aspect of your transaction to be trouble-free. That's why we strive to keep everything as simple for you as possible. We're always looking for new ways to serve you better and we welcome your ideas for how to do that."

- Renee, Accounting Department, 23 years of service

CYLINDER HEAD REBUILDING  
CLEANING, ASSEMBLY & SAFETY  
SHORT BLOCK REBUILDING  
CRANKSHAFT/ FLYWHEEL GRINDING  
MISCELLANEOUS TOOLS & SUPPLIES  
BRAKE & TIRE CHANGING TOOLS  
MEASURING TOOLS  
V-TWIN & METRIC HARD PARTS

## Knurling Arbors

- Piloted for positive centering
- Use by hand or with electric drill & speed reducer
- **Not for use on chilled, hardened or bronze guides**

Inch	mm	Jobber	Order No.
.236"	6.00	\$89.99	WKA-6MM-G
.275"	7.00	89.99	WKA-7MM-G
.312"	7.92	89.99	WKA-312-G
.343"	8.71	89.99	WKA-343-G
.375"	9.53	89.99	WKA-375-G
.437"	11.10	99.99	WKA-437-G
1 Quart Knurlube (946.6mL)		14.79	WLB-47-G

**NOTE: We don't stock knurling arbors smaller than 6mm because smaller guides are chilled and these arbors may fail.**

**tech tips**  
from the techxperts  
Use with Knurlube



## Bronze Reaming Oil

- Prevents build-up
- Extends reamer life
- Improves valve guide finish

Size	Jobber	Order No.
1 Pint	\$ 9.99	BW-303-G
1 Quart	15.99	BW-303A-G
1 Gallon	35.99	BW-305-G



## Knurlube

- High pressure lube
- Prevents tool damage
- Extends knurler life by reducing friction and arbor wear

Size	Jobber	Order No.
½ Pint	\$10.49	WLB-46-G
1 Quart	14.79	WLB-47-G



## Carbide or High Speed Steel Valve Guide Top Cutters

- Matches Seat & Guide machine pilots

Description	Shank	Jobber	Order No.
<b>Cutters</b> 1½" High-Speed Steel	.500"	\$ 57.99	GFH-100
1½" High-Speed Steel	.486"	99.99	GFH-300
1½" Carbide	.500"	149.99	GFC-200
<b>Shank Pilots</b> ¾" (.1875")	.312" / 7.93mm	14.99	GFP-312
	.343" / 8.73mm	14.99	GFP-343
	.375" / 9.53mm	14.99	GFP-375
	.437" / 11.11mm	14.99	GFP-437
	.500" / 12.70mm	14.99	GFP-500



## 1" Diameter Carbide Top Cutter / Spot Facer

- Long-life, quick-cutting carbide blades
- Shorten or face cast-iron valve guides and stud bosses up to 1" / 25.4mm diameter
- Universal drive shank fits all types of power chucks ¾" or larger

Description	Jobber	Order No.
<b>Cutter Body</b>	\$99.99	G-1270
<b>Pilot</b>		
	.312" / 7.93mm	15.79 G-1270A
	.343" / 8.73mm	15.79 G-1270B
	.375" / 9.53mm	15.79 G-1270C
	.437" / 11.11mm	15.79 G-1270D

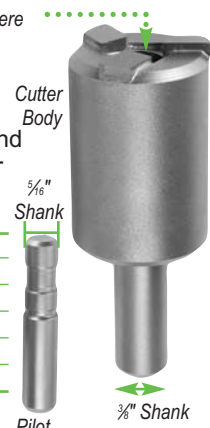

Pilot Installs Here

Cutter Body  
¾" Shank  
Pilot  
¾" Shank

## Electric Drill Drive Adaptors For Knurling Arbors and/or Reamers



Use **WSR-41-3-G** (¼" sq.) or **WSR-41-4-G** (⅜" sq.) with **WSR-41-7-G** (⅝" drill adaptor). Clamp ⅝" drive in drill to drive reamers directly.

Description	Jobber	Order No.
<b>A</b> Drill Adaptor for 3/8" drill	\$ 7.99	WSR-41-7-G
<b>B</b> 1/4" Adaptor for arbors/reamers larger than .281"	10.99	WSR-41-3-G
<b>C</b> 3/8" Adaptor for arbors/reamers .281" or smaller	14.99	WSR-41-4-G
<b>D</b> Slip on Adaptor (converts WSR-41-3-G to .1875")	19.99	WSR-41-5-G

## Valve Guide OD Knurling Tool

- Enlarge guides to fit bore
- Ideal for rare metric sizes and aluminum heads with damaged guide bores
- Works on most materials, **except** chilled or hardened guides

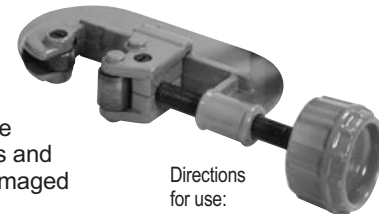

Directions for use:

**tech tips**  
from the techxperts  
Hold guide firmly in Vise, Drill Press or Seat & Guide machine; tighten the knurler and turn it around the guide by hand. Increase OD up to .002".

Description	Jobber	Order No.
<b>Complete Tool</b>	\$59.99	VGK-25
Knurling Wheel	23.99	VGK-25W
Knurling Rollers (2)	9.99	VGK-25R

## Valve Guide OD Machining Tool Does 3 Jobs at Once!

- Face the guide top to the correct size
- Sizes the guide OD for press-on seals
- Chamfers the top to prevent seal damage
- Cutters & pilots are interchangeable and chuck into any portable drill, drill press or seat & guide machine



### Individual Cutters

Guide OD in.	mm	Order No.
.415"	10.5	VSC-415
.428"	10.8	VSC-428
.475"	12.1	VSC-475
.495"	12.6	VSC-495
.500"	12.7	VSC-500
.530"	13.5	VSC-530
.562"	14.3	VSC-562
.625"	15.9	VSC-625

Jobber \$71.99

### Pilots

Guide ID in.	mm	Order No.
¾"	7.0	VP-7MM
⅝"	7.9	VP-312
1½"	8.7	VP-343
¾"	9.5	VP-375

Jobber \$27.99

### Cutter and Pilot Assemblies

Guide OD in.	mm	Pilot Size in.	mm	Order No.
.415"	10.5	⅝"	7.9	VSC-415312
.428"	10.9	⅝"	7.9	VSC-428312
.475"	12.1	⅝"	7.0	VSC-475275
.475"	12.1	⅝"	7.9	VSC-475312
.495"	12.6	1½"	8.7	VSC-495343
.500"	12.7	⅝"	7.9	VSC-500312
.500"	12.7	1½"	8.7	VSC-500343
.500"	12.7	¾"	9.5	VSC-500375
.530"	13.5	⅝"	7.9	VSC-530312
.530"	13.5	1½"	8.7	VSC-530343
.530"	13.5	¾"	9.5	VSC-530375
.562"	14.3	⅝"	7.9	VSC-562312
.562"	14.3	1½"	8.7	VSC-562343
.562"	14.3	¾"	9.5	VSC-562375
.625"	15.9	¾"	9.5	VSC-625375

Jobber \$89.99

# Valve Stem Oil Seals

Buy 3 or more boxes of seals (mix & match) and take an extra 10% off jobber



## Valve Stem Oil Seals

- Better oil regulation than umbrella-type • Seals mount firmly on guide & wipe valve stem clean of excess oil • Sized precisely for proper lubrication
- 32 per box (VVS-495 is 16 per box)

NOTE: Seals marked with \* are high-temperature exhaust seals • Valve Seal Cutters on page 34

2-Ring Rubber				
Guide OD	Stem OD	Cutter & Pilot Needed	Jobber	Order No.
.562"	.341"	(VSC-562343)	\$49.49	3011F*
.562"	.341"	(VSC-562343)	35.79	3011D
.625"	.372"	(VSC-625375)	26.29	3012

High Temperature				
Guide OD	Stem OD	Cutter & Pilot Needed	Jobber	Order No.
.495"	.341"	(VSC-495343)	\$28.99	VVS-495
.531"	.341"	(VSC-530343)	34.79	3711F*

PTFE				
Guide OD	Stem OD	Cutter & Pilot Needed	Jobber	Order No.
.415"	.311"	(VSC-415312)	\$48.29	5910
.500"	.341"	(VSC-500343)	54.79	5611
.500"	.372"	(VSC-500375)	64.99	5612
.531"	.311"	(VSC-530312)	59.99	5710
.531"	.341"	(VSC-530343)	55.79	5711
.531"	.372"	(VSC-530375)	59.99	5712



Seals enlarged to show detail

PTFE and Rubber				
Guide OD	Stem OD	Cutter & Pilot Needed	Jobber	Order No.
.500"	.311"	(VSC-500312)	\$30.49	4610
.500"	.341"	(VSC-500343)	54.49	4611
.500"	.372"	(VSC-500375)	54.49	4612
.531"	.341"	(VSC-530343)	57.79	4711
.562"	.341"	(VSC-562343)	56.49	4811
.625"	.372"	(VSC-625375)	49.79	4012

SEE PAGE 125 FOR MOTORCYCLE VALVE SEALS

## Universal! Fits all 1/32" Valve Stems

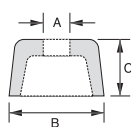

- A) Stem Dia: Seal stem dia. should be smaller than valve stem: Glass/Nylon seals, .003" to .008" smaller. Rubber, at least .025" smaller.
- B) Outside Dia: Must clear ID of the valve spring and divert oil from the guide.
- C) Height: Must clear retainer as valve spring is compressed for lock installation.

Type	QTY.	(A)	(B)	(C)	Jobber	Order No.
High Temp: Glass/Nylon Umbrella	32	.335"	.715"	.455"	\$8.49	8563
Low Temp: Rubber Umbrella	32	.310"	.755"	.560"	8.49	6120
Low Temp: Rubber O-Ring	100				6.29	6333

## Cummins Diesel Valve Seals

sized for diesel



Intake and Exhaust Seals enlarged to show detail

### For Intake & Exhaust

- For 24 valve, 7mm Cummins Diesel Engines

Application	Stem Size	OD	Qty.	Jobber	Order No.
Intake	7.0mm	.511"	12	\$13.99	CVS-59i
Exhaust	7.0mm	.511"	12	13.99	CVS-59E

## Valve Seal Puller

- .810" tool dia.
- Fits Multi-Valve Engines
- Lifts from the bottom of the seal
- Works within the confines of lifter bucket bores
- Fingers grip seal for fast, easy removal
- Works on most domestic and import vehicles

Description	Jobber	Order No.
Valve Seal Puller	\$199.99	VSP-323
Replacement Shaft	34.99	VSP-323-4
Replacement O-Ring	3.99	VSP-323-5
Replacement Jaw Set	77.29	VSP-323-3
Replacement Jaw Sleeve	41.99	VSP-323-1
Black Split Sleeve	24.99	VSP-323-2

Parts are interchangeable with VSP-320

new design



Now with 3 fingers



### Valve Stem Seal Puller

- Plier handles rotate to any position above the head while the jaw assembly goes into the spring cavity
- Can be used straight or at any angle up to 90°
- Jaw tip includes thin ledge for "hooking" underneath stubborn valve stem seals
- 4 vertical raised ridges on inner jaw diameter help grip the outside diameter of the seal
- Order No. **VSP-629** Jobber \$49.99



## AV&V Seal Drivers

- A must-have tool for installing valve seals • Aluminum

Seal Size	Order No.	Seal Size	Order No.
4.5mm	VSD-4.5MM	5.0mm	VSD-5MM
5.5mm	VSD-5.5MM	6.0mm	VSD-6MM
7.0mm	VSD-7MM	7/16"	VSD-312
8.0mm	VSD-8MM	3/8"	VSD-375

Jobber \$23.99

## Universal Seal Pliers

- Works on OHC and in-line engines with recessed springs
- Long, serrated jaws reach into confined areas and grip seals firmly
- Heat-treated steel with easy-grip handles
- Order No. **VSP-823** Jobber \$49.99



## Premium Seals & Valve Seal Cutter for Chevy Vortec 5.7L

- Install aftermarket high lift camshafts without spring to seal interference
- Cuts the guide height and chamfers the valve guide OD at the same time

Description	Jobber	Order No.
Vortec Seal Cutter	\$71.99	VSC-495
1/32" Hardened & Ground Pilot	27.99	VP-343
.495" ID Metal Seals (16 pack)	28.99	VVS-495
Spring Seat Cutter	89.99	VSS-1320

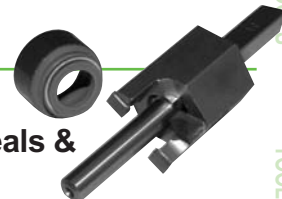

CYLINDER HEAD REBUILDING

CLEANING, ASSEMBLY & SAFETY

SHORT BLOCK REBUILDING

CRANKSHAFT/ FLYWHEEL GRINDING

MISCELLANEOUS TOOLS & SUPPLIES

BRAKE & TIRE CHANGING TOOLS

MEASURING TOOLS

V-TWIN & METRIC HARD PARTS



**Pneumatic Head:**  
Adjustable to 25° in either direction for canted valves



**Head Support:**  
Table adjusts 45° to the front and 30° to the rear

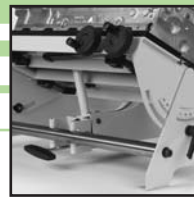

**Positive Stops:** Adjusts front and rear angles



**Speed Knobs:**  
Allows quick positioning of workpiece

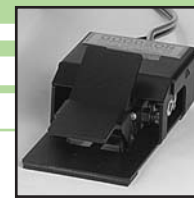

**Foot Pedal:**  
Easy, hands-free operation



**Quick Release Knob:**  
Allows fast positioning to opposite cam bank

### Pneumatic Valve Spring Press

- Pneumatic valve support holds valve closed as you compress the spring
- Adjustable stainless steel plate won't damage the head
- 28mm Valve Spring Adaptor is standard with unit (other sizes are available, see chart on page 37)
- Ideal for use on heads with recessed springs
- For aluminum and cast iron heads
- Fully assembled
- Measures 28"L x 24"W x 26"H
- Order No. **PSB-5000**  
Jobber \$5,299.99

**Goodson  
exclusive**

**Slide Hammer:**  
A quick tap loosens keepers for fast removal

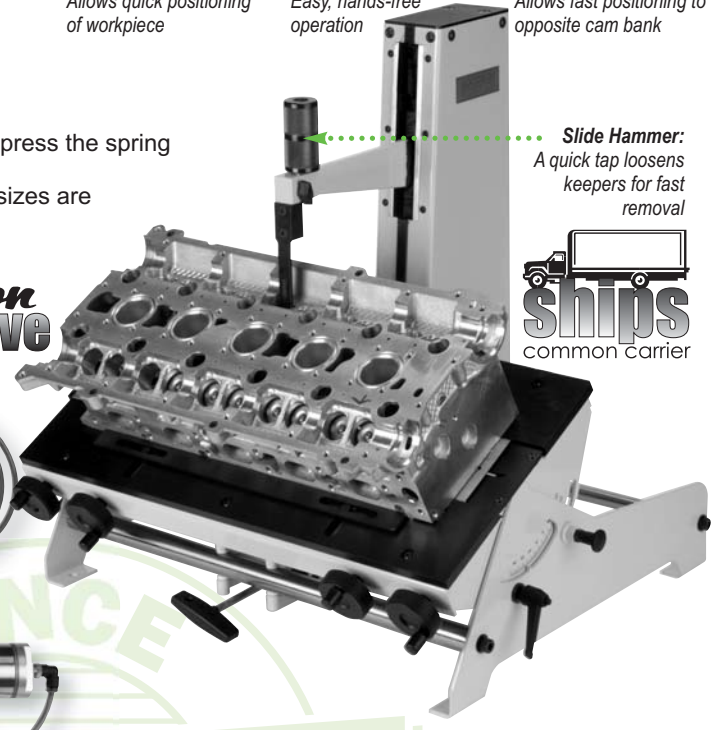

### GOODSON Pneumatic Valve Spring Compressors & Accessories

- Deliver 325 lbs. of force at 130 PSI • Handle springs from 3/4" to 1 3/4" diameter • Fingertip control
- Replaceable jaws • Full 1 year warranty

Description	Jobber	Order No.
Complete Valve Spring Compressor	\$399.99	<b>CF-2004</b>
Retrofit Cylinder & Valve Assembly Kit (retrofits most common pneumatic compressors)	399.99	<b>CF-2003</b>
Adjustable Automotive Valve Spring Compressor	499.99	<b>CF-2002</b>
Adjustable Diesel Valve Spring Compressor	569.99	<b>CF-2008</b>
<b>Replacement Parts and Accessories</b>		
Replacement Valve Spring Adaptor Jaw	\$13.99	<b>CF-44</b>
Replacement Valve Spring Adaptor Jaw - HD	22.99	<b>CF-44HD</b>
Replacement 1/4" Green Air Line (sold by lin. ft.)	1.99	<b>CF-2001-AL</b>
Replacement Air Control Needle Valve	42.99	<b>CF-2001-NV</b>
Replacement Pneumatic Cartridge	9.99	<b>CF-2003-C</b>
1/4" NPT L-Fitting	5.99	<b>CF-2003-BCE</b>
1/8" NPT L-Fitting	3.99	<b>CF-2003-L</b>

**American Made**

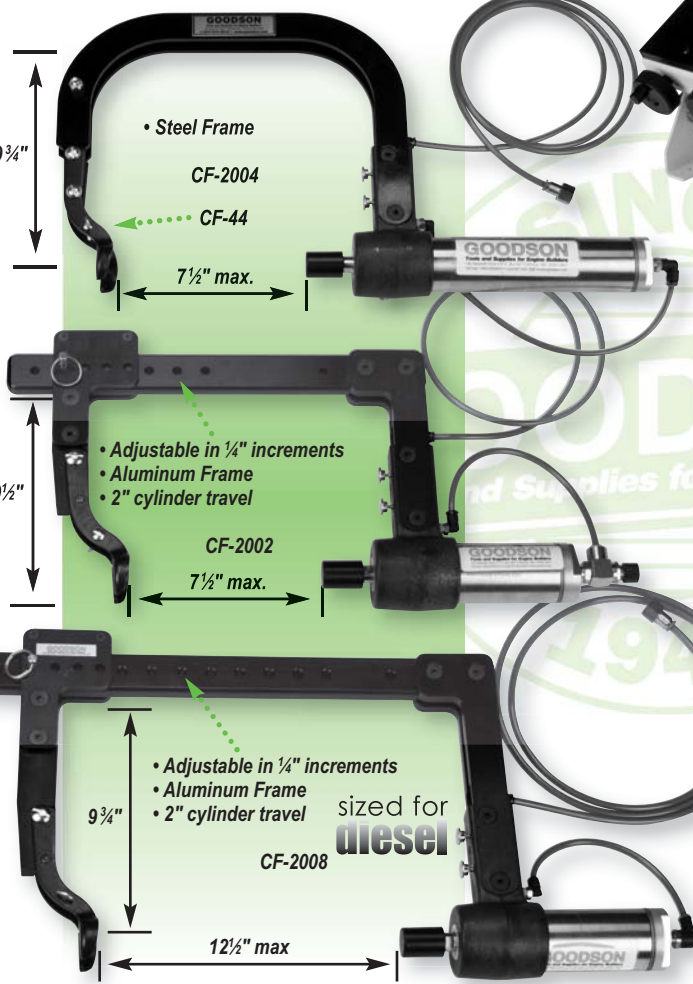

### Convert your CF-2002 Spring Compressor for use with Multi-Valve OHC Heads

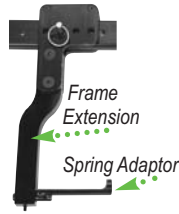

Description	Jobber	Order No.
Frame Extension	\$69.99	<b>CF-2050</b>
<b>Recessed Spring Adaptors</b>		
21mm OD	55.99	<b>CF-2010</b>
26mm OD	55.99	<b>CF-2032</b>

**Retrofit Cylinder & Valve Assembly Kit**  
Fits most common Pneumatic Spring Compressors including our CF-2004. Fasteners included.  
Order No. **CF-2003** Jobber \$399.99



# Valve Spring Compressors

**Goodson  
exclusive**



## Speed Up Valve Spring Replacement With The Manual Valve Spring Bench

- Remove and install valve springs on heads with recessed springs
- 26"L x 22"W x 35"H footprint and weighs 31 lbs.
- Includes 28mm dia. spring adaptor
- Locking collar can be used to stop vertical travel or to keep the spring compressed while assembling keepers
- Frame tilts up to 25° in either direction for canted valves
- Full cylinder head support is adjustable from 0 to 45°
- Integral slide hammer easily releases stuck keepers
- Other spring adaptors also available (see chart below)
- Replacement parts available
- Order No. **CF-500** Jobber \$1,799.99

Keeper Tools on p. 38-39



**Lock Collar:**  
Can be used to stop vertical travel or to hold spring compressed while assembling keepers



**Adjustable Frame:**  
Adjustable to 25° in either direction for canted valves



**Locking Arm:**  
Holds the C-frame securely in position at the desired angle



**Head Support:**  
Adjustable from 0-45° and locks in place



**Dowel Pins:**  
Keeps the workpiece in place at any head support angle



**Slide Hammer:**  
A quick tap releases keepers that are stuck in retainers

## Spring Adaptors for Valve Spring Benches

- Fit both manual (**CF-500**) and pneumatic (**PSB-5000**) spring benches
- Nylon insert is replaceable



Description	Reach	Jobber	Adaptor	Jobber	Insert
18mm	4½"	\$259.99	CF-518	\$18.99	CF-518-1
23mm	4½"	259.99	CF-501	18.99	CF-501-1
28mm	3½"	259.99	CF-502	18.99	CF-502-1
35mm	2½"	259.99	CF-503		insert not required



CF-44



CF-44HD

## Valve Spring Adaptor Jaws

- Fit frames with double locking screws to secure jaws such as Goodson **CF-2002**, **CF-2004**, **CF-2008** and **CF-140** • Heavy duty jaws are non-adjustable

Description	Jobber	Order No.
Standard Duty 1.000"-1.875" (25.4-47.6mm) Range	\$13.99	CF-44
Heavy Duty (non-adjustable)	22.99	CF-44HD

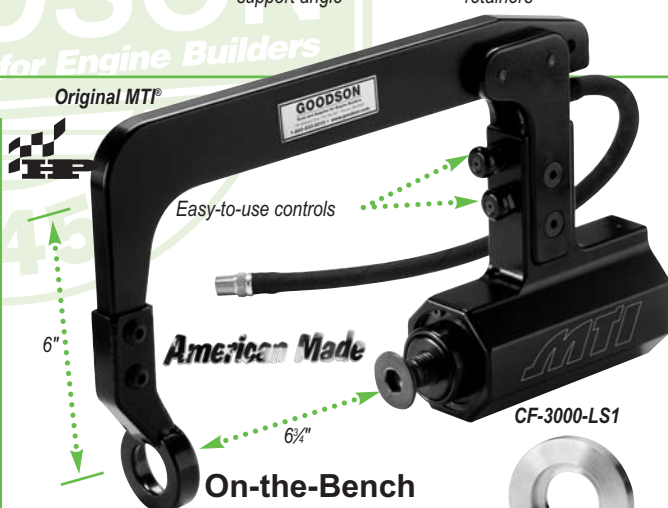

## On-the-Bench Pneumatic Spring Compressor

- Handles springs up to 1500 lbs. at 90 PSI!
- Standard heavy-duty jaw fits springs up to 1.600" diameter
- Optional jaw fits springs to 1.740" diameter
- Features a dual stage cylinder that produces more force each time the control is pressed
- **Guaranteed to a maximum of 90 psi/620.5 kPa pressure**

Description	Jobber	Order No.
Hi-Perf. Spring Compressor with 1.600" ID Jaw	\$1,299.99	CF-3000B
Replacement Standard Jaw, 1.600" ID	119.99	CF-3002
Adaptor Jaw, 1.740"/44.2mm ID	119.99	CF-3003
LS1 Series Jaw Adaptor	34.99	CF-3000-LS1
Rebuild Seal Kit (includes Intake Button Return Spring)	34.99	CF-3000SK
Replacement Intake Button Return Spring only	8.99	CF-3004
Intake Trigger Assembly	49.99	CF-20004A
Exhaust Trigger Assembly	44.99	CF-20004B

**new**

CYLINDER HEAD REBUILDING

CLEANING, ASSEMBLY & SAFETY

SHORT BLOCK REBUILDING

FLYWHEEL GRINDING

CRANKSHAFT/ MISCELLANEOUS TOOLS & SUPPLIES

BRAKE & TIRE CHANGING TOOLS

MEASURING TOOLS

V-TWIN & METRIC HARD PARTS



"You'll always get fast, reliable service from Goodson, even on international orders. We'll do whatever it takes to make sure you get your shop supplies as quickly and easily as possible - anywhere in the world."

- Kim, Goodson Customer Service Manager, 32 yrs. of service

CYLINDER HEAD REBUILDING

CLEANING, ASSEMBLY & SAFETY

SHORT BLOCK REBUILDING

CRANKSHAFT/ FLYWHEEL GRINDING

MISCELLANEOUS TOOLS & SUPPLIES

BRAKE & TIRE CHANGING TOOLS

MEASURING TOOLS

V-TWIN & METRIC HARD PARTS



## Manual Valve Spring Compressor

- Weighs only 6 lbs
- High leverage allows for easy, one-hand operation
- Covers a range from 10" high to 8" deep
- Works with most valve-in-head and L-head engines
- Fits truck & tractor engines
- Jaws adjust for small, medium and large springs

Description	Jobber	Order No.
Spring Compressor	\$89.99	CF-140
Replacement Jaw Set	13.99	CF-44
HD Replacement Jaw Set	22.99	CF-44HD



## small engine powersports

### Manual Valve Spring Compressor

- Compress **only** the spring for fast and easy keeper removal
- Fully adjustable steel jaws have maximum opening of 2 1/2" (63.5mm)
- For springs 1/2" (12.7mm) to 1 1/8" (28.6mm) in diameter
- Cadmium finished spring steel construction
- Order No. **CF-131** Jobber \$17.99

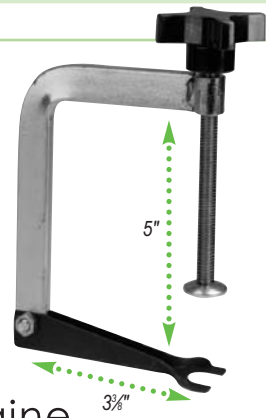

### Manual Valve Spring Compressor For Small Engines

- Once you lock the compressor in position, your hands are free to work
- Includes 2 jaw sets - small, for springs up to 7/8" (22.2mm) and large, for springs up to 1 1/16" 27.0mm)
- Order No. **CF-600** Jobber \$21.99

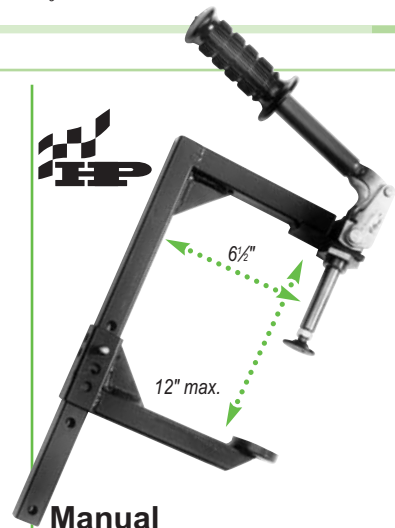

### Manual Valve Spring Compressors

- Handle valve springs from a range of applications
- Welded, gusseted all-steel construction takes plenty of abuse
- Plenty of leverage to compress valve springs

Description	Jobber	Order No.
High Performance Spring Compressor	\$234.99	CF-1500
3/4" Replacement Adaptor for CF-1400	\$34.99	CF-6

Tools and Supplies for Engine Builders

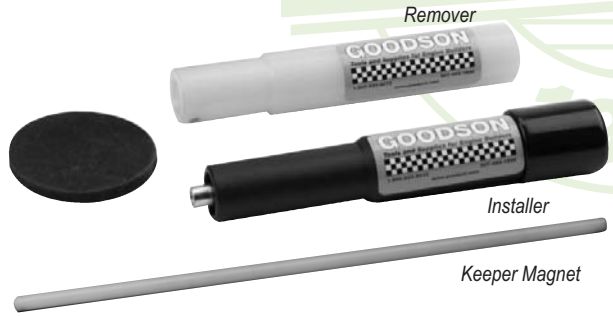

## Small OHV Engine Keeper Removal/Installation Tool

- Easy to use - Uses your own body weight as leverage to remove or install keepers
- Works with 3.5mm to 5.5mm single groove valves only
- Complete set includes a remover with powerful magnet to hold the keepers in place after removal, universal installer to fit valve stems from 3.5 to 5.5mm and two non-slip valve chamber pads

Description	Jobber	Order No.
Keeper Removal Installation Tool	\$99.99	VKI-35
Keeper Magnet - 6 5/8" holder with .170" dia. earth magnets	15.99	VKM-17

## Valve Spring Compressor Adaptor

- Fit seat and guide machines or drill press
- Puts collet or drill press chuck behind adaptor
- Allows more room to remove or re-install valve keepers and associated components
- Fits 1/2" collet or Jacobs chuck (not included)

OD (mm)	Reach (mm)	Jobber	Order No.
3/4" (19.1)	3 3/4" (95.3)	\$34.99	CF-6
1 1/16" (20.6)	3 3/4" (95.3)	34.99	CF-8
1" (25.4)	3 3/4" (95.3)	39.99	CF-10
1 1/4" (31.7)	3 3/4" (95.3)	39.99	CF-12
1 1/2" (38.1)	3 3/4" (95.3)	39.99	CF-15



## Adaptors for Deeply Recessed Springs

- Open top design gives easy access to keepers
- Durable, non-marring material
- Fit on Split-Jaw Spring Adaptors such as our **CF-44** (p. 37)



Description	OD	Height	Jobber	Order No.
Small Adaptor	26mm	4" (101.6mm)	\$27.79	CF-32
Medium Adaptor	27mm	3" (76.2mm)	27.79	CF-24-G
Large Adaptor	32mm	3" (76.2mm)	27.79	CF-25-G



Spring sold separately



## L-Head Manual Spring Compressor

- Easily removes springs in recessed area of valve in block engines
- Handle turns to open and close the compressor
- Integral jaws accommodate springs up to 1 1/8" OD
- Sized for industrial engines - Continental, Waukesha, etc.
- Use with Flat Head straight stem valves, 1949 & newer
- Order No. **CF-122** Jobber \$19.99



## Pneumatic Valve Spring Compressor Rebuild Kit

- For pneumatic spring compressors with threaded shaft such as Plews, Clark Feather, etc.
- Includes seals, valves, springs and o-rings
- Order No. **CF-700-RK** Jobber \$84.99

CF-21A-G



CF-22C-G



CF-23-G



## Standard Valve Spring Adaptors

- For threaded shaft spring compressors
- Thumb screw adjustment
- Single locking screw secures jaw to frame

Adjustment Range	Jobber	Standard
.875" - 1.875" (22.2-47.6mm)	\$14.99	<b>CF-21A-G</b>
1.00" - 2.000" (25.4-50.8mm)	14.99	<b>CF-22C-G</b>
1.50" - 2.500" (38.1-63.5mm)	15.99	<b>CF-23-G</b>
Replacement Thumb Screw	1.49	<b>CF-700-2-G</b>

## Heavy Duty Valve Spring Adaptors

- Heavy duty jaws are not adjustable

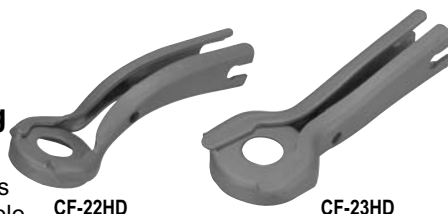

Adjustment Range	Jobber	Standard
1.00" - 2.000" (25.4-50.8mm)	\$27.49	<b>CF-22HD</b>
1.50" - 2.500" (38.1-63.5mm)	27.49	<b>CF-23HD</b>



## V-Twin On-the-Engine Valve Spring Compressor

Replace broken valve springs, install high performance valve springs, remove and replace valve guide seals all without disassembling the bike – just remove the gas tank and get to work. Use on Sportster, Evolution, Twin-Cam and most aftermarket V-Twins. Kit includes valve spring compressor, adaptor for compressing beehive springs, valve seal driver/installer and head pressurizing hose.

Order No. **CF-HDIF** Jobber \$159.99

Visit the Goodson Blog for more information on using the On-The-Engine Spring Compressor <http://www.goodson.com/blog/?p=3646>

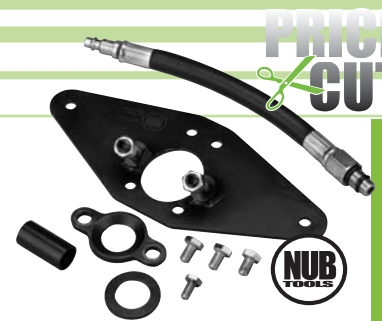

PRICE CUT

CYLINDER HEAD REBUILDING

CLEANING, ASSEMBLY & SAFETY

SHORT BLOCK REBUILDING

FLYWHEEL GRINDING

CRANKSHAFT/ MISCELLANEOUS TOOLS & SUPPLIES

BRAKE & TIRE CHANGING TOOLS

MEASURING TOOLS

V-TWIN & METRIC HARD PARTS

## Keeper Installation Tools

Best Keeper Tool on the Market!

- Spring-loaded plunger
- For single & multi-groove keepers
- Reaches keeper grooves located farther from the valve tip • Ideal for use with **CF-500** (p. 37) and **PSB-5000** (p. 36)

Size	Jobber	Order No.
4mm / .1563"	\$79.99	<b>VKI-4</b>
5mm / .2031"	79.99	<b>VKI-5</b>
6mm / .2344"	79.99	<b>VKI-6</b>
7mm / .2812"	79.99	<b>VKI-7</b>
8mm / .3125"	79.99	<b>VKI-8</b>
Replacement Rubber Sleeve	6.99	<b>VKI-56</b>



CF-842

VKM-17

VK-15

## Keeper Tools

Description	Jobber	Order No.
Keeper Tool	\$ 8.99	<b>CF-842</b>
Keeper Magnet – 6 5/16" holder .170" dia. earth magnet	15.99	<b>VKM-17</b>
Keeper-Keeper – PVC 3/4" holes keep keepers in	15.99	<b>VK-15</b>

# Full Service ...FAST!!



"Our staff of ASE-Certified Techxperts® can help you solve problems fast! Call with questions about product applications, machining precision, longer tool life, improving efficiency, cost savings or any other technical topic. We're here to help you!"

- Erik, Tech Support Manager, 15 years of service

CYLINDER HEAD  
REBUILDING

CLEANING,  
ASSEMBLY & SAFETY

SHORT BLOCK  
REBUILDING

CRANKSHAFT/  
FLYWHEEL GRINDING

MISCELLANEOUS  
TOOLS & SUPPLIES

BRAKE & TIRE  
CHANGING TOOLS

MEASURING  
TOOLS

V-TWIN & METRIC  
HARD PARTS

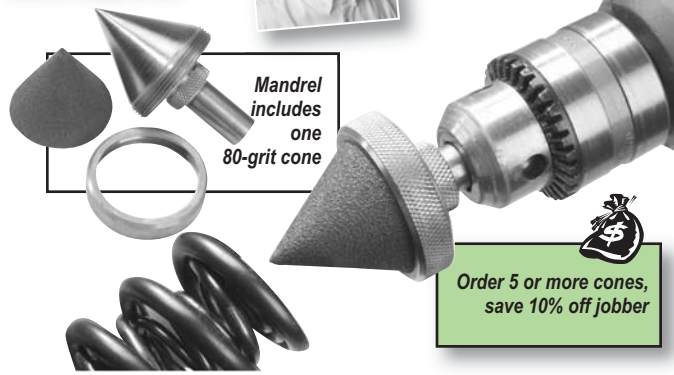

Mandrel  
includes  
one  
80-grit cone

Order 5 or more cones,  
save 10% off jobber

## Small Chamfering Cones & Mandrels Make Deburring and Chamfering Easy In Tight Spaces

These mandrels are available in two diameters – 3/4" and 1 1/2" diameters with a 1/2" shank to fit most portable drills. The small diameter fits easily into tight spaces such as Beehive Valve Springs (see page 129) or bolt holes. The mandrel is designed to support a 60° abrasive cone which is held securely by the retaining ring. One 80-grit cone is included with initial purchase.

Description	Jobber	Order No.
3/4" dia. Mandrel	\$57.79	CC-34
3/4" Dia. Abrasive Cones	80 grit	2.99 CC-35
	120 grit	2.99 CC-36
1 1/2" dia. Mandrel	\$60.99	CC-60
1 1/2" Abrasive Cones	80 grit	4.29 CC-61
	120 grit	4.29 CC-62

## Universal Gel Lube

- Sprays on as a liquid and forms into a gel within seconds
- Penetrating formula blends freely with motor oil
- Multiple uses, including cams, lifters, rocker arms bearings, pistons/wrist pins, cylinders, etc.
- Provides lubrication for engines subjected to prolonged storage before initial start-up
- Aerosol\*
- Order No. **GL-8U** Jobber \$17.99



Buy 6 or more cans and save 10% off jobber

\*Hazardous Goods Fees Will Apply if Shipped by Air



3-D Fast Cut™  
Adjustable Spring Pad  
Cutters on page 10

## Valve Spring Seat Cutters

- Resize valve spring seats to maintain spring-to-valve concentricity or use to enlarge seats for over-size dual springs
- Requires special pilot – see chart below

### Carbide Tipped Cutter Bodies (use VP pilots below)

OD	ID	Order No.
1.320"	.630"	VSS-1320
1.350"	.625"	VSS-1350
1.500"	.625"	VSS-1500
1.550"	.625"	VSS-1550
1.625"	.625"	VSS-1625
1.680"	.750"	VSS-1680HD
1.750"	.625"	VSS-1750

Jobber \$89.99

### Hardened & Ground Pilots

Guide ID	Order No.
3/32"	7.0 VP-7MM
5/16"	7.9 VP-312
11/32"	8.7 VP-343
3/8"	9.5 VP-375

Jobber \$27.99

## tech tips

from the techxperts™  
You must use these pilots with the VSS and VSC cutters. The flat sides are necessary for a proper fit.

## 8 Piece Valve Train Checking Spring Set

- Essential for high-performance engine building • 1.250" OD
- Maintain a positive valve train position while checking valve to piston clearance
- Order No. **VTS-8** Jobber \$14.99



Buy the kit and  
SAVE!

## Dial Indicated Valve Stem Height Gauges

- 5 sizes to choose from
- Small diameter extended measuring body allows extra height for dial indicator clearance
- Use with our large-faced Dial Indicator to check valve tip height



Description	Jobber	Order No.	Incl.		
Valve Stem Height Gauge Kit w/Stand	\$199.99	VSH-KIT			
Valve Stem Height Gauge Kit	119.99	VSH-200			
Valve Stem Height Gauge for Harley®	69.99	VSH-HD-KIT			
Dial Indicator (2" travel, .001" graduations)	59.99	MDI-2	x x		
Dial Indicator (1" travel, .001" graduations)	27.99	EDI-1	x		
Measuring Bodies					
	OD	ID	OAL		
	.750"	.625"	3.830"	\$39.99 VSH-205	x
	.900"	.770"	2.840"	39.99 VSH-203	x
	.900"	.770"	3.840"	39.99 VSH-204	x
	1.060"	.812"	2.840"	39.99 VSH-201	x x x
	1.250"	1.090"	3.300"	39.99 VSH-202	x x
Tool Stand	44.99	TS-5	x		
1" Checking Standard	9.99	MCS-1	x		

More dial indicators on page 120

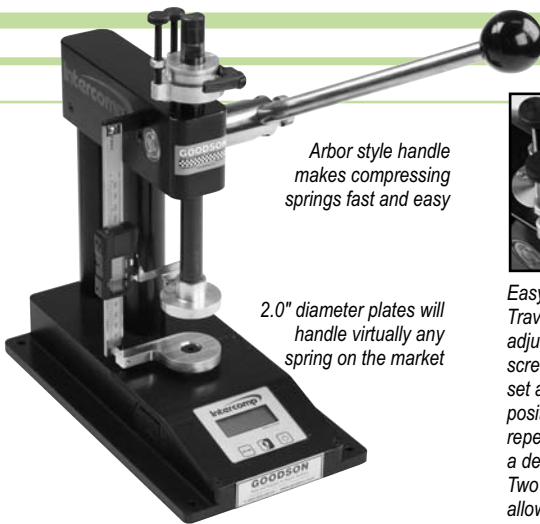

Arbor style handle makes compressing springs fast and easy

2.0" diameter plates will handle virtually any spring on the market



Easy to use Travel Stop with adjustable set screws lets you set an exact position, allowing repeated testing at a desired height. Two set screws allow you to adjust for installed spring height and max lift (near coil bind).

**American Made**

**Intercomp®  
Digital Arbor Valve Spring Tester**

- 1,500 lb / 680.4 kg load cell in 1 lb. increments
- Force units switchable from pounds to kilograms
- Billet 6061 T-6 Aluminum construction
- Digital travel readout at .001"/inch or .01/mm
- 5" travel capacity • 2.0" diameter spring pads
- Easy to read backlit screen
- Operates on 9V battery (included)
- Adjustable stop to repeatedly check springs at the same heights
- Order No. **VST-2000** Jobber \$1,399.99

For routine calibration of spring testers, return tester to Goodson. Call for details, 1-800-533-8010.



**Economy  
Valve Spring Tester**

- Measure spring pressure to ±2% • Compress spring with drill press or vise • Use a ruler or caliper to measure spring height (see page 122 for calipers) • Rugged design



Pressure Range	Jobber	Order No.
0 - 300 lbs. (2 lb. increments)	\$139.99	<b>VST-300</b>
0 - 600 lbs. (5 lb. increments)	159.99	<b>VST-600</b>

**Calibrated Spring**

- Check Spring Tester Accuracy
- Highest-quality spring steel
- Calibrated to show pressure at a specified compressed height includes calibration certificate)
- Rating: Min. = 100 lbs., Max. = 285 lbs.
- Order No. **VST-95** Jobber \$57.99



New Pressure Gauge reads in both pounds and kilograms

Vertical scale reads in inches on one side and millimeters on the other



**American Made**



**Analog Valve Spring Tester**

- 5" diameter Ashcroft analog pressure gauge with 600 lb. (272kG) capacity in 10 lb. (4.54kG) increments
- Platform handles springs up to 2" diameter x 4½" OAL
- Vertical height adjustments in ¼" increments
- Adjustable pressing anvil for fine-tuning open and closed pressures for height measurement
- T-Handle conforms to the operator's grip for firm control
- Calibrated and sealed hydraulic load cell
- Over-center cam action holds spring at the desired height
- Rubber protective boot keeps the mechanism debris-free
- Base features four ¼" mounting holes to bolt it to the bench
- Order No. **VST-60G** Jobber \$879.99

**TECHNICAL SPECS:**  
UNIT WEIGHT: 19½ lbs.  
FOOTPRINT: 8½" Sq.  
HEIGHT: 28" with handle fully extended

**tech tips**  
from the techexperts™

**What is coil bind and how is it measured?**

Coil bind is the point at which a valve spring is fully compressed so that there is no space between the coils. You do **NOT** want your springs to reach this position when in use since it will cause damage to the camshaft and valve train components. To measure coil bind height, install the retainer in the valve spring and compress the spring until the coils are stacked tightly together. Measure from the bottom of the spring to the bottom of the retainer. This is your coil bind height.



**Height Indicator**

- Measure compressed spring height when testing pressure
- Ideal for high performance and checking identical springs
- For Rimac® and other spring testers
- Digital Height Indicator reads inches and metric
- Includes dial indicator, and mounting kit (additional dial indicators on page 120)
- Order No. **VST-25** Jobber \$67.99

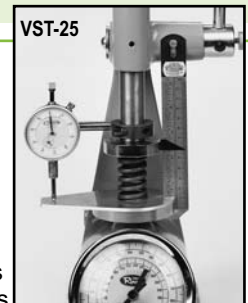

CYLINDER HEAD REBUILDING  
CLEANING, ASSEMBLY & SAFETY  
SHORT BLOCK REBUILDING  
FLYWHEEL GRINDING  
CRANKSHAFT/ FLYWHEEL GRINDING  
MISCELLANEOUS TOOLS & SUPPLIES  
BRAKE & TIRE CHANGING TOOLS  
MEASURING TOOLS  
V-TWIN & METRIC HARD PARTS



"We work hard to earn your business; every day, every order. You can count on Goodson to be your most reliable and friendly source for shop supplies"

- Richard, Customer Service - 16 years of service

CYLINDER HEAD REBUILDING

CLEANING, ASSEMBLY & SAFETY

SHORT BLOCK REBUILDING

CRANKSHAFT/ FLYWHEEL GRINDING

MISCELLANEOUS TOOLS & SUPPLIES

BRAKE & TIRE CHANGING TOOLS

MEASURING TOOLS

V-TWIN & METRIC HARD PARTS

## Non-Serrated Valve Spring Booster Shims

- Shims meet or exceed OE specifications
- Made of prime quality cold rolled steel
- Support valve springs better
- Won't compress
- Maintains pressure and protects head from spring abrasion
- Non-serrated shims won't damage spring pad area on aluminum heads or cause lateral loads or harmonics

Special Orders are available. Call 1-800-533-8010 to inquire.



Size	50 count High Performance			100 count			
	OD	ID		.060"	.030"	.015"	
1.000"	0.688"			A-101	B-101	C-101	
	0.765"			A-104	B-104		
1.100"	0.719"				B-106		
1.218"	0.875"			A-105	B-105		
	0.625"	A-107-HP	B-107-HP	C-107-HP	A-107	B-107	C-107
1.250"	0.812"	A-203-HP	B-203-HP	C-203-HP	A-203	B-203	C-203
	0.875"				A-201	B-201	
1.360"	1.000"	A-102-HP	B-102-HP	C-102-HP	A-102	B-102	
1.375"	0.765"	A-301-HP	B-301-HP	C-301-HP		B-301	
1.437"	0.785"	A-305-HP	B-305-HP	C-305-HP			
1.438"	0.645"	A-306-HP	B-306-HP	C-306-HP			
1.480"	0.703"	A-303-HP	B-303-HP	C-303-HP	A-303	B-303	
1.500"	0.645"	A-306S-HP	B-306S-HP	C-306S-HP			
	1.031"	A-103-HP	B-103-HP	C-103-HP	A-103	B-103	
1.634"	0.643"	A-601-HP	B-601-HP	C-601-HP			
Jobber		\$19.99	\$19.99	\$19.99	\$19.99	\$19.99	\$19.99



## Magnetic Head Bolt Washer & Valve Spring Shim Removal Tools

Avoid self-inflicted wounds from sharp spring shim removal tools or the ever-popular oil shower from using air pressure to remove head bolt washers. The hollow design of these magnetic removal tools allow easy access over studs or head castings and the powerful earth magnets grab firmly, letting you lift the washer or shim out easily.

Description	Jobber	Order No.	Incl.
Magnetic Remover Set	\$109.99	MWR-SET	▼
Washer Removers	ID	OD	
	0.250"	0.625"	\$31.99 MWR-14 x
	0.500"	0.865"	31.99 MWR-12 x
	0.450"	0.812"	31.99 MWR-716 x
Shim Remover	0.708"	1.355"	34.99 MVS-2 x



No More Guesswork... Measure CCs Accurately!

Tools and Supplies for Engine Builders



Clear acrylic plate lets you see when the chamber is full

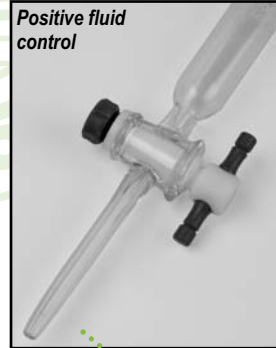

Positive fluid control

100cc Glass Buret allows use with alcohol or solvent

Clamp gives you ability to fully adjust the height of the buret in relation to your cylinder head

## Cylinder Head CC-ing Equipment

- Use glass buret with alcohol or solvent
- Positive on/off fluid control valve
- Clear acrylic plate lets you see when the combustion chamber is full

Description	Jobber	Order No.	Incl.
CC-Measurement Kit	\$169.99	CCB-KIT	▼
100cc Glass Buret	99.99	CCB-100	x
5" x 5" x 3/8" Acrylic Plate	10.99	GCB-3	x
Buret Cleaning Brush - 35/2" OAL	9.99	GCB-BRUSH	x
Buret Stand	17.99	GCB-1	x
Buret Clamp	17.99	GCB-2	x
Funnel	10.49	CCB-FUNNEL	x
Measuring Liquid Concentrate (Gallon)	10.99	GCB-LIQUID	
4" Precision Cylinder Head Level	154.99	LEV-4	
Replacement Vial for 4" level	99.99	VGL-101	
100cc Glass Beaker	39.99	GC-100	

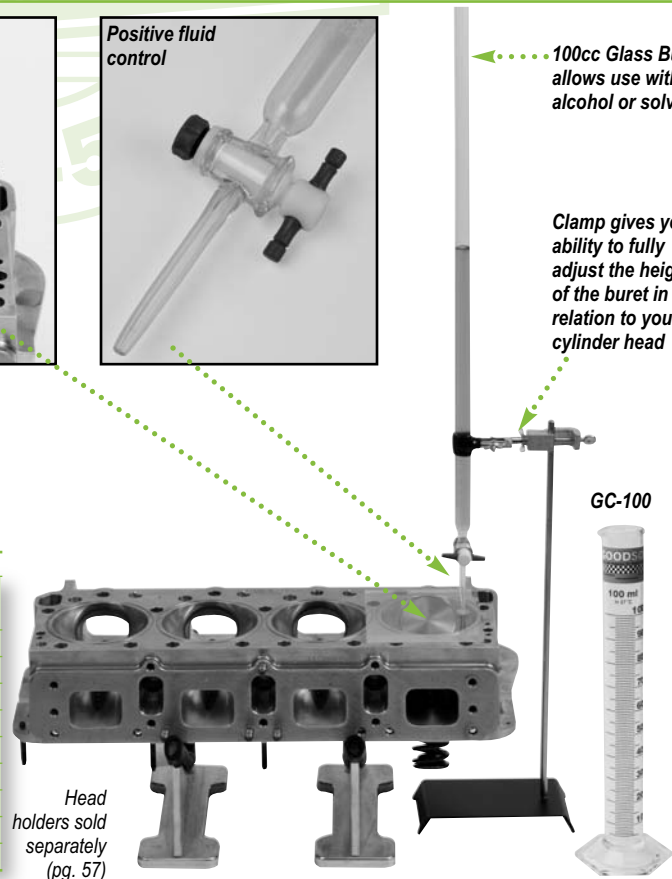

Head holders sold separately (pg. 57)

# Cylinder Head Resurfacing

## tech tips

from the techxperts™  
Confirm level calibration before every use.



## 2-Way Resurfacing Set-up Level

- Top-quality CNC machined T-6 aluminum frame with hardened & ground tool-steel contact pads
- Level both directions at once
- Includes 6" precision vials (LEV-8-1)
- Weighs just 2 lbs.
- Order No. LEV-TR  
Jobber \$374.99



## Precision Levels and Vials

- Graduated vials with satin-chromed, brass protective covers that rotate to close tightly
- Base castings are seasoned, then precision machined and finished on a bearing surface • Replaceable vials
- Adjustable for precise calibration
- 1 division equals .0005" per inch
- Fits pilots as small as 6mm



Description	Jobber	Order No.	Replacement Vial
4" Valve Guide Level (3" vial)	\$199.99	VGL-100	\$ 99.99 VGL-101
4" Level (3" vial - nominal)	154.99	LEV-4	99.99 VGL-101
8" Level (6" vial - nominal)	219.99	LEV-8	129.99 LEV-8-1
12" Level (8" vial - nominal)	299.99	LEV-12	149.99 LEV-12-1

## Import / Metric Cylinder Head Stud Stretchers

- Save time, don't remove the studs from a head for resurfacing • Put stud stretchers on two studs and leave the rest • Sold in pairs

Length	Thread	Jobber	Order No.
3"	8mm x 1.25	\$53.99	SS-20
3 3/4"	8mm x 1.25	53.99	SS-30
3 3/4"	10mm x 1.25	53.99	SS-40

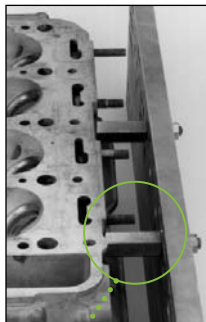

## PCD Inserts for Aluminum

- A must for shops committed to meeting today's strict surface finish requirements
- Fits all machines with 3/8" and 1/2" type CBN holder
- 1/2" diameter inserts require shim (included)
- Use with Resurfacing Spray (HPS-16) for best results (see below)

resharpening available

Size	Jobber	Order No.
3/8" (9.53mm) Diameter	\$179.99	PCDS-375
1/2" (12.7mm) Diameter (shim included)	189.99	PCDS-500

## CBN Cutter Inserts For Cast Iron

- Faster and cleaner than segments and wheels



Titanium-Nitride Coated

Dia.	Thick.	Sided	Jobber	Order No.
3/8"	1/8"	Double	\$179.99	CBN-375D
	1/8"	Single	159.99	CBN-375S
1/2"	1/8"	Double	229.99	CBN-500D*
	3/16"	Single	249.99	CBN-500S

Sharp Uncoated

Dia.	Thick.	Sided	Jobber	Order No.
3/8"	1/8"	Single	\$139.99	CBNS-38
1/2"	3/16"	Single	167.99	CBNS-12

resharpening available

\*NOTE: A 1/8" thick carbide shim must be used with CBN-500D on DCM machines  
• Order No. CBN-500SHIM  
Jobber \$21.99

resharpening available

Enlarged for clarity

## Super Abrasive For Cast Iron Diesel Heads

- Designed for cast diesel heads with hardened pre-cups • Won't chip
- Fits all overhead surfacers with 1/2" diameter insert capacity
- Will NOT work on standard cast heads
- .500" (12.7mm) diameter • .125" (3.2mm) thick
- Order No. DRD-500 Jobber \$299.99



\*NOTE: A 1/8" thick carbide shim must be used with DRD-500 on DCM machines  
• Order No. CBN-500SHIM Jobber \$21.99

Buy 6 or more cans, save 10% off jobber  
Mix or match with High Performance Resurfacer Spray (HPS-16), Cutting & Tapping Fluid (CTF-14) and Minnesota Fast Freeze (MFF-8) to achieve the quantity discount



## High Performance Resurfacing Spray

- Prolongs cutter life
- Enhances surface finish
- Refreshing scent • Aerosol\*
- Order No. HPS-16 Jobber \$11.99



\* Hazardous goods fees apply when shipped air

CYLINDER HEAD REBUILDING  
CLEANING, ASSEMBLY & SAFETY  
SHORT BLOCK REBUILDING  
FLYWHEEL GRINDING  
CRANKSHAFT/ FLYWHEEL GRINDING  
MISCELLANEOUS TOOLS & SUPPLIES  
BRAKE & TIRE CHANGING TOOLS  
MEASURING TOOLS  
V-TWIN & METRIC HARD PARTS



"We are committed to maintaining your privacy. Information about you and your business is never sold, rented or given to anyone outside of our company."

- Sue, Goodson Database Manager - 30 years of service

CYLINDER HEAD REBUILDING

CLEANING, ASSEMBLY & SAFETY

SHORT BLOCK REBUILDING

CRANKSHAFT/ FLYWHEEL GRINDING

MISCELLANEOUS TOOLS & SUPPLIES

BRAKE & TIRE CHANGING TOOLS

MEASURING TOOLS

V-TWIN & METRIC HARD PARTS

### Silicon-Carbide Abrasive



### Aluminum Oxide Abrasive



### Aluminum Oxide & Silicon-Carbide Abrasive

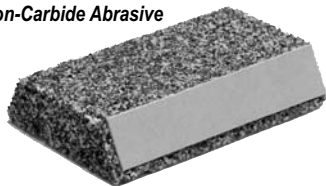

### Aluminum Oxide Abrasive



Colors may vary

**SAVE!**  
Buy a complete set of 8 or more segments and take 10% off jobber!

## tech tips

from the techxperts™

### 4 keys to resurfacing aluminum heads:

#### 1) Choose the correct abrasive

Use a speckle wheel segment to grind aluminum heads.

#### 2) Lubricate, lubricate, lubricate

Put a light coat of **Grind-Aid (GRA-10)** on the abrasive to reduce aluminum build-up on the wheel. Speed up the traverse and reduce the cut to .0005" - .0010" per pass.

#### 3) Dress for success

To keep grains open, dress the wheel often. Don't dress before the last pass but be sure to apply Grind-Aid liberally to let the stone give a finer surface finish.

#### 4) Keep heat build-up to a minimum

The greatest danger is heat build-up that can cause scoring as aluminum transfers to the stone. Avoid this by taking shallow cuts and using plenty of lubrication.

## Resurfacing Wheel Segments

Segments are available in a variety of compositions. Match the abrasive to the material for best results and longest life. Order segments in 8, 10 or 12 piece sets.

Width	Thickness	Length	Application	Abrasive	Jobber	Order No.
2.56"/65mm	0.98"/25mm	3.94"/100mm	Cast Iron & Aluminum	Silicon-Carbide	\$18.99	GS-PBS
			Steel & Hardened Metals	Aluminum Oxide	22.99	GS-PBS-1
			Aluminum, Cast Iron, Hardened Iron & Steel	Aluminum Oxide and Silicon-Carbide	22.99	GS-PBS-2
			Steel & Hardened Metals	Aluminum Oxide	21.99	GS-PBS-3
For Peterson/Peterson Berco 1055 AWL, RSC950 (std.), SYP320, -360, -1000, -1300, RSC1200, -1550 RPYS1500 models. For Winona Van Norman SM-2000, SM-4000/5000, MG-4000, SM-6000C/6000A and MG-3000/3850 models. For Storm Vulcan RT7Y Late (Serial No. 103152 and up) and RT 17Y Late (Serial No. 128697 and up) models.						
3.13"/79mm	0.81"/21mm	3.13"/79mm	Cast Iron & Aluminum	Silicon-Carbide	\$21.99	GS-SVS
			Aluminum, Cast Iron, Hardened Iron & Steel	Aluminum-Oxide and Silicon-Carbide	21.99	GS-SVS-2
For Peterson/Peterson Berco RG-32, RTY, RG-35, RG-300/900 models. For Storm Vulcan RT 7Y Early (Serial no. up to 103151) and RT 17Y Early (Serial no. up to 128696)						
1.97"/50mm	0.67"/17mm	3.62"/92mm	Cast Iron & Aluminum	Silicon-Carbide	\$18.99	GS-RGS
2.56"/65mm	0.79"/20mm	3.94"/100mm	Steel & Hardened Metals	Aluminum Oxide	\$21.99	GS-KWS
			Aluminum, Cast Iron, Hardened Iron & Steel	Aluminum-Oxide and Silicon-Carbide	21.99	GS-KWS-2

For Kwik-Way 858 and 862 models

**NOTE:** To maintain proper cutting action Goodson strongly recommends that you replace your cylinder head resurfacing segments in full sets. See your user's manual for wheel diameter and number of segments required. Need help choosing the abrasive? Call the Goodson Techxperts™

Resurfacing Segments are guaranteed for 1 year from original purchase date

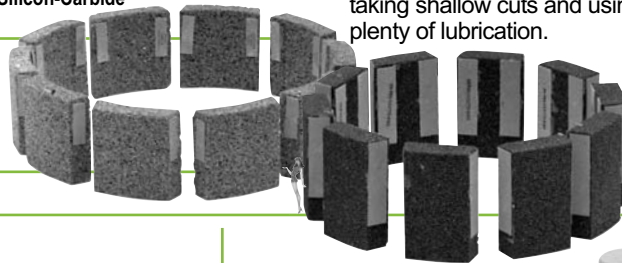

Buy 6 or more tubes, save 10% off jobber!

## Grind Aid

- Cools and lubricates
- Stops premature grain fracturing
- Improves surface finish
- Handy twist tube with cover
- Reduces glazing and loading
- Essential when resurfacing aluminum heads
- Order No. **GRA-10** Jobber \$16.99

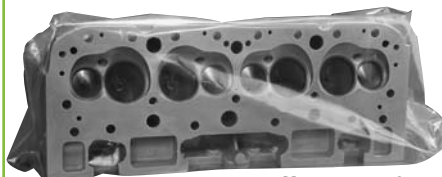

## Cylinder Head Storage Bags

- 3 mil thickness
- 17"x44" / 43.2 cm x 111.8cm
- 100 per roll
- Order No. **BC-17** Jobber \$69.99

More storage bags on page 69

## Rust Shield Aerosol\*

- Choose between short and long term protection
- Spray on right after resurfacing
- Remove short term with soap & water and long term with solvent



Formula	Jobber	Order No.
Short Term	\$12.99	RS-16
Long Term	16.79	RS-16-OD

Order 6 or more cans, save 10% off jobber

\*Hazardous Goods Fees Apply When Shipped Air

# Cylinder Head Resurfacing

**Buy 3 or more,  
save 10% off jobber**  
**Buy 5 or more,  
save 15% off jobber**



## Cylinder Head Resurfacing Belts

A belt has three important parts: abrasive, bond and backing. Goodson belts are made for top performance and long life. Our belts also feature a unique splice that permits use in both directions for even longer wear; when worn one way, turn belt around to resurface more heads.

**Abrasive:** Match the abrasive to the workpiece (aluminum, cast iron or steel) and to your machine for the longest belt life.

**Bond:** Double-layer, heat-resistant resin holds abrasive firmly. Bond is so strong that grains wear out instead of loosening.

**Backing:** Waterproof, poly-back belt won't tear or fray. It's the toughest backing of any resurfacing belt.



**Selection Guide: which abrasive works best on what materials...**

	STEEL	Ceramic (40g)
	STEEL	Nor-Zon® (40g)
ALUM	CAST IRON	Aluminum-Oxide (40g)
		Silicon-Carbide (40g)
		Silicon-Carbide (80g)

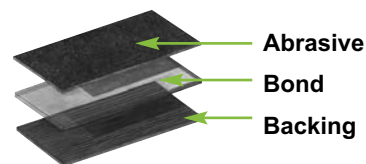

To check which size belt is needed to fit your machine, see the groups of resurfacers listed below.



### Silicon-Carbide 40-grit:

- Good-quality • Black
- Primarily for cast iron but can resurface aluminum if extra care is used
- Down-pressure optional
- SGS-14-86-60 is a 60 grit belt

### Silicon-Carbide 80-grit:

- Good-quality • Black
- Designed especially to resurface aluminum
- Down-pressure not recommended

### Ceramic 40-grit:

- Best-quality • Maroon
- Perfectly uniform grain
- Outlasts other types of belts
- For cast iron or steel
- Down-pressure recommended

### Nor-Zon® 40-grit:

- Better-quality • Blue/Green
- Grains fracture under pressure to stay sharp
- For cast iron or steel
- Down-pressure recommended

COLORS FOR REFERENCE ONLY ... DUE TO MANUFACTURING PROCESS, ACTUAL COLORS MAY VARY • RESURFACING BELTS ARE GUARANTEED FOR 1 YEAR FROM ORIGINAL PURCHASE DATE

Belt Size	Machine	Jobber	Order No.	Jobber	Order No.	Jobber	Order No.	Jobber	Order No.
11 7/8" x 76"	(A)	\$54.99	SGS-11-76	\$49.99	SGA-11-76	---	---	\$74.99	SGB-11-76
11 7/8" x 79"	(B)	54.99	SGS-11-79	49.99	SGA-11-79	---	---	74.99	SGB-11-79
11 7/8" x 89"	(C)	57.99	SGS-11-89	49.99	SGA-11-89	---	---	79.99	SGB-11-89
11 7/8" x 91"	(D)	61.99	SGS-11-91	49.99	SGA-11-91	---	---	---	---
14" x 86"	(E)	67.99	SGS-14-86-60*	49.99	SGA-14-86	---	---	---	---
14" x 103"	(F)	74.99	SGS-14-103	69.99	SGA-14-103	---	---	124.99	SGB-14-103
14" x 107"	(G)	84.99	SGS-14-107	64.99	SGA-14-107	---	---	124.99	SGB-14-107
14" x 113 1/2"	(H)	89.99	SGS-14-113	64.99	SGA-14-113	\$139.29	SCB-14-113	124.99	SGB-14-113
15" x 127 1/2"	(I)	104.79	SGS-15-127	67.99	SGA-15-127	164.99	SCB-15-127	149.99	SGB-15-127

A) Winona Van Norman BG-600 B) RMC, Peterson RG-1203 C) RMC-800, Serv-Equip PG-1229 D) Peterson RG-1234 & Kansas Instruments E) Automotive Craftsman F) Master Tool G) Kwik-Way 870 Master Surfacer H) Storm Vulcan / Anderson AB-1000A, Peterson PG-1400 I) Storm Vulcan / Anderson AB-1540A, Anderson AB-1540, IDL HS-4350, Peterson PG-1500, Winona Van Norman BR-1500, BG-1515 & BG-1520



## Belt Resurfacer Coolant

- Semi-synthetic
- Rust-inhibiting
- For ALL belt resurfacers with a coolant sump
- Pink • Dilute 30:1

Size	Jobber	Order No.
1 Gal.	\$ 27.99	SGB-10
5 Gal.	137.99	SGB-50

**Save 10% on 10!**

Order 10 or more Resurfacing Carbide Cutter Tips  
OR Rotary Broach Tool Bits and SAVE 10% off jobber



resharpening available



## Rotary Broach Tool Bit For Van Norman 530, 570 & VM-2000

- One-piece cutter
- Order No. VN-65C Jobber \$19.99



SV-85BE

Enlarged for clarity

FC-858-3

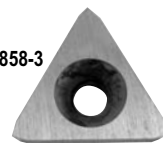

## Carbide Cutter Replacement Tips For Broach Style Surfacers

Fits	Jobber	Order No.
Storm Mill 85, 85B, 85BE, 85C, 85N & 280	\$28.99	SV-85BE
KW-858	32.99	FC-858-3



"Goodson accepts major credit cards, debit cards, bank drafts and personal checks. Call us for more information."

- Bev, Goodson Accounting/Inventory Control Manager - 32 years of service

CYLINDER HEAD  
REBUILDING

CLEANING,  
ASSEMBLY & SAFETY

SHORT BLOCK  
REBUILDING

CRANKSHAFT/  
FLYWHEEL GRINDING

MISCELLANEOUS  
TOOLS & SUPPLIES

BRAKE & TIRE  
CHANGING TOOLS

MEASURING  
TOOLS

V-TWIN & METRIC  
HARD PARTS

# The most complete resurfacing program in the industry ...

## 1. Consistent high-quality abrasives

Each Goodson resurfacer wheel is made to the highest standards of roundness, balance and strength. Extensive quality control, start-to-finish, lets us back our abrasives with our Iron-Clad Guarantee\* of total satisfaction.

## 2. Full inventory at all times

Since we specialize in the distribution of abrasives to machine shops world-wide we always carry an extensive inventory. We rarely put resurfacer wheels on backorder. Call Goodson, we have what you need on our shelves.

## 3. Same day shipping

We usually ship your order the same day that we receive it. If your order is received after 5:00pm central time, or on a weekend or holiday through our website, we will ship it the next business day. Along with our huge inventory, our shipping speed ensures consistently faster delivery when you order from Goodson.

\* Due to the characteristics of abrasive wheels we are only able to guarantee grinding wheels for 1 year from the original purchase date.



## Surface Grinding Coolant

- Synthetic • Water soluble • Non-foaming
- Non-nitrate • Dilute 20:1 • Always use ample coolant to keep your cutting surface cool and to flush away grinding debris

Size	Jobber	Order No.
1 Gal. (3.78 L)	\$ 29.99	SGC-10
5 Gal. (18.93 L)	129.99	SGC-50

## Single-piece Resurfacer Wheels

- Meet or exceed OE standards established for general purpose grinding applications • Silicon-Carbide abrasive • Banding will wear off to expose more abrasive

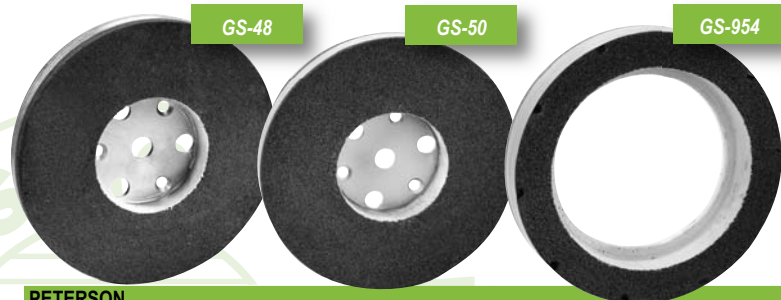

### PETERSON

Machine Model(s)	Size: dia. x height x face width	Grit	Jobber	Order No.
All 14" Dry Grinders	14" x 1½" x 4" Plate	36	\$389.99	GS-48
All 14" Dry Grinders	14" x 1½" x 4" Plate	24	419.99	GS-50
1054	16" x 2" x 2" Inserted Nut	16	409.99	GS-954



### KWIK-WAY

Machine Model(s)	Size: dia. x height x face width	Grit	Jobber	Order No.
545,545H,855	12" x 3" x 1½" (Serrated) Plate	16	\$384.99	GS-545
545B,856,855-5,860	14" x 3" x 1½" (Serrated) Plate	24	519.99	GS-545B
545BL,860A, L & T	16" x 3" x 1½" (Serrated) Plate	24	589.99	GS-545BL

Grinding Wheels are guaranteed for 1 year from original purchase date

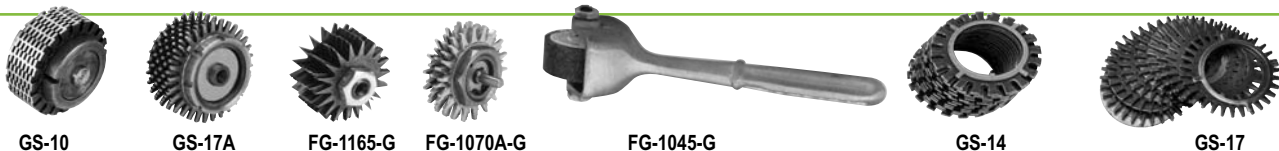

## Grinding Wheel Dressers & Replacement Cutters

Diamond Dresser Tools are available on pages 104-105

Applications	Cutter Assemblies				Replacement Cutters					
	OD	ID	W	Jobber	Order No.	Pieces	Washers	Size	Jobber	Order No.
VN, Lempco, Storm RT-7Y, 17Y	2.500"	1.500"	.0625"	\$84.99	GS-10	14 stars	1 w/locking tangs	1.75" x .058"	\$22.99	GS-14
Peterson (12mm shaft)	2.375"	1.500"	.0938"	87.99	GS-17A	8 stars	5	2" x 1.50" x .028"	22.99	GS-17
							1 w/locking tangs	1.75" x 1.5" x .06"		
WVN SM2000, 4000, 5000, 6000C, 6000A, MG3000, 3850	1.250"	0.313"	.0625"	29.99	FG-1165-G	7 stars	none	1.25" x .313" x .095"	7.99	FG-1161-G
Peterson & DCM	2.375"	1.125"	.125"	69.99	FG-1070A-G	5 stars	1	1.624" dia. x .031"	15.99	FG-1070-G
Hand held				49.99	FG-1045-G	1 stone	none	1.500"x.313"x.625"	13.99	FG-1044-G



# Vacuum Testers

**Goodson**  
exclusive



Vacuum relief valve  
Exhaust port filter keeps the vacuum running smoothly and quietly

DVC-2011 comes complete with pistol grip and a 4.75" vacuum plate. Other plates shown below.

DVC-2011-HK

DVC-475

Optional Hose Kit includes 3 feet of 1/4" Air Line, L-Fitting, Filter, Straight Fitting, Robinair Fitting and Straight Coupler. All parts are also sold separately.

## Replacement Vacuum Tester Plates for Sioux™ 1630K

- Closed cell foam for an exceptional seal
- Replacement foam also available separately
- Several sizes to choose from or ask for a custom size
- Plate lube improves the seal for even better vacuum holding power
- Plate Kit below includes Plate Lube (DVC-PL)

### Sioux-Style Replacement Plates for the 1630K Tester

Size	OE No.	Jobber	Order No.	Incl.
Sioux-Style Fitting Replacement Plate Kit		\$179.99	SVT-7KIT	▼
2" / 50.8mm dia.	1630-2	26.99	SVT-2	x
3" / 76.2mm dia.	1630-3	29.99	SVT-3	x
4.75" / 120.7mm dia.	1630-4	34.99	SVT-475	x
6" / 152.4mm dia.	1630-6	39.99	SVT-6	x
2"x3" / 50.8 x 76.2mm		27.99	SVT-23	x
3"x4" / 76.2 x 101.6mm		31.99	SVT-34	x
Replacement Sioux-Style Fitting		13.99	DVC-SX	

### Accessories & Replacement Parts

Description	Jobber	Order No.
6 Pc. Replacement Foam Set - 1 of each size	\$34.99	FOAM-KIT
Plate Lube - 8 oz. / 236.6 mL	5.99	DVC-PL x
Replacement Line Filter	10.99	DVC-FILTER
Replacement Mat - 11" x 31" x 3/8"	39.99	DVC-1131

## Pistol Grip Vacuum Tester

- Lightweight - only 1.9 lbs. without the plate
- Pulls and holds up to 24 PSI vacuum on as little as 90 PSI
- Quick coupling Robinair fittings
- Easy to reach controls for single-handed operation
- Hard-anodized billet aluminum
- Tester includes one 4.75" vacuum plate

Description	Jobber	Order No.	Incl.
Pistol Grip Vacuum Tester Kit with 4.75" Vacuum Plate	\$599.99	DVC-2011	
<b>Optional Vacuum Plates</b>			
Robinair Fitting Replacement Plate Set	\$129.99	DVC-7KIT	▼
2.00" / 50.8mm Diameter Vacuum Plate	20.99	DVC-2	x
3.00" / 76.2mm Diameter Vacuum Plate	23.99	DVC-3	x
4.75" / 120.7mm Diameter Vacuum Plate	28.99	DVC-475	x
6.00" / 152.4mm Diameter Vacuum Plate	29.99	DVC-6	x
2"x3" / 50.8x76.2mm Vacuum Plate	21.99	DVC-23	x
3"x4" / 76.2x101.6mm Vacuum Plate	26.99	DVC-34	x
<b>Parts &amp; Accessories</b>			
Pressure Gauge	\$37.99	DVC-GAUGE	
Flexible Hose Kit (optional)	36.99	DVC-2011-HK	▼
1/8" NPT "L" Fitting	3.99	CF-2003-L	x
1/8" NPT Female Coupling	12.29	LDP-AR-6	x
Inline Air Filter	10.99	DVC-FILTER	x
1/8" x 1/8" Straight Fitting	5.99	DVC-SF	x
Nipple Coupling	6.99	DVC-1N	x
3' Air Line	lin. ft. price 1.99	CF-2001-AL	x
Robinair Fitting	5.29	DVC-SN	
1/8" NPT Male Coupling	14.99	DVC-1M	
Plate Lube 8 oz. (236.6 mL)	5.99	DVC-PL	

## Heavy Duty Manual Vacuum Tester

- Cover combustion chamber with rigid foam backed plate and pump vacuum
- A steady reading of 25" (63.5cm) indicates proper valve seating
- All metal construction
- 4 3/4" plate & fittings included
- DVC Plates (above) will fit this tester

Description	Jobber	Order No.
Manual Vacuum Tester	\$169.99	DVC-101-HD
Replacement 4.75" Plate	28.99	DVC-475

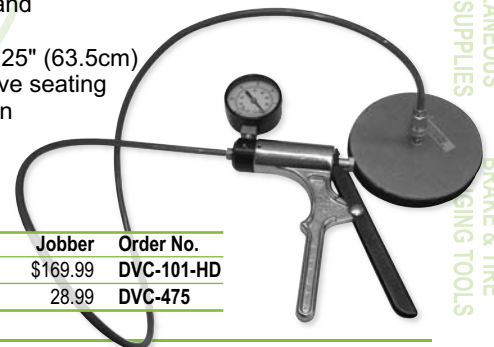

## Vacuum Testing

**tech tips**  
from the techxperts™

Vacuum testing is the fastest method for testing valve to seat integrity. Simply assemble your machined cylinder head and install the spark plugs. Use a reliable vacuum source producing approximately 24 lbs. HG on the vacuum gauge and a closed cell foam test plate with a through fitting to draw down or evacuate the combustion chamber.

Once you've reached 24 lbs. HG on the gauge and close the vacuum to the chamber. Watch the gauge for a drop in vacuum. It should hold steady confirming that you have achieved valve to seat mating.

Coat the face of your closed cell foam test plate with Plate Lube (DVC-PL) to condition the foam. This produces a soft, yielding material that will fill minor head surface blemishes or imperfections.

CYLINDER HEAD  
REBUILDING

CLEANING,  
ASSEMBLY & SAFETY

SHORT BLOCK  
REBUILDING

FLYWHEEL GRINDING

CRANKSHAFT/  
MISCELLANEOUS  
TOOLS & SUPPLIES

BRAKE & TIRE  
SERVICING TOOLS

MEASURING  
TOOLS

V-TWIN & METRIC  
HARD PARTS

From our customers:

"Goodson's Fluorescent Magnetic Powder works great! Cracks glow bright yellow under black light. We find the fluorescent powder much more effective at picking up cracks than any powder that we have used in thirty years of crack detection."  
Steve & Ed Walsh - Steve's Machine Shop Service Liberty, NY, Goodson Customer since 1994

CYLINDER HEAD REBUILDING

CLEANING, ASSEMBLY & SAFETY

SHORT BLOCK REBUILDING

CRANKSHAFT/ FLYWHEEL GRINDING

MISCELLANEOUS TOOLS & SUPPLIES

BRAKE & TIRE CHANGING TOOLS

MEASURING TOOLS

V-TWIN & METRIC HARD PARTS



**Specifications**



**MMP-100 / MMP-100S**

- Physical: 7 7/8" x 9 1/4" x 2 1/8"  
187 x 235 x 54mm
- Max. Span: 12" (304.8mm)  
across poles
- Voltage: 115V (MMP-100)  
230V (MMP-100S)
- Line Current: 4 amp (MMP-100)  
3 amp (MMP-100S)
- Weight: 6.5 lb (2.95 kg)
- Cord: 10' L, 3-wire



**MMP-210 / MMP-210S**

- Physical: 10 1/2" x 11" x 2 3/4"  
266 x 280 x 70mm
- Max. Span: 18" (457mm) across  
poles
- Voltage: 115V (MMP-210)  
230V (MMP-210S)
- Line Current: 8 amp (MMP-210)  
3 amp (MMP-210S)
- Weight: 13 lb (5.9 kg)
- Cord: 10' L, 3-wire

Articulating legs adjust to a wide range of angles, allowing you to test uneven surfaces with ease



**Magnetic Crack Detection Units**

- Articulating legs conform to virtually any surface configuration
- Designed for one-person operation • Lightweight
- No transformer box to drag around • 230V units feature a pigtail on the cord
- Easy to access switches • Full 1-Year Manufacturer's Warranty for Repair
- 50% duty cycle (example: 2 minutes on, 2 minutes off)
- Produce a strong AC magnetic field

Description	Jobber	Order No.
115V Electronic Crack Detector with 10# Pull	\$514.99	<b>MMP-100</b>
115V Heavy Duty Electronic Crack Detector with 22# Pull	649.99	<b>MMP-210</b>
230V Electronic Crack Detector with 10# Pull	524.99	<b>MMP-100S</b>
230V Heavy Duty Electronic Crack Detector with 22# Pull	659.99	<b>MMP-210S</b>

**Non-Fluorescent Magnetic Powder for Dry Method Particle Inspection**

- Works with all dry magnets including Magnaflux® and Parker
- Store in a moisture free environment



**American Made**

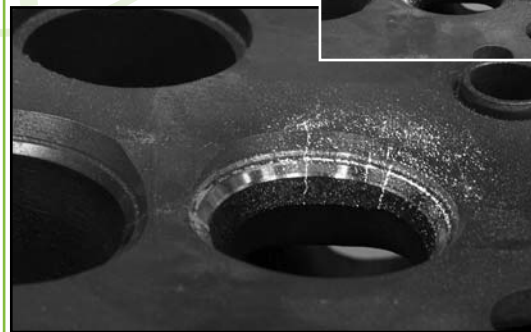
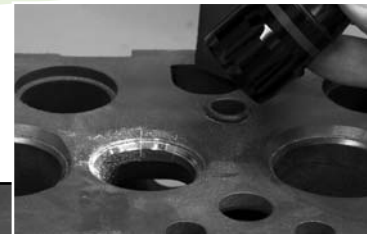

Size	Jobber White	Jobber Yellow	Jobber Red
1 lb.	\$ 9.99 WCD-100-G	\$ 9.99 WCD-101-G	\$ 9.99 WCD-103-G
5 lb.	42.99 WCD-500-G	42.99 WCD-501-G	42.99 WCD-503-G
25 lb.	199.99 WCD-2500-G	199.99 WCD-2501-G	199.99 WCD-2503-G



**Magnetic Powder Applicators**

- A quick & easy method for distributing magnetic powder

Description	Jobber	Order No.
Atomizer Assembly for small areas	\$24.99	<b>MM-301</b>
Applicator Bulb for large areas	19.99	<b>WCD-266-G</b>
Replacement Bulb for Atomizer Jar	12.79	<b>MM-301-1</b>

**Green Fluorescent Magnetic Powder**

- For dry magnetic inspection methods
- Makes crack detection easier
- Cracks glow bright yellow under ultraviolet light but can also be seen under normal lighting conditions

Quantity	Jobber	Order No.
1 lb.	\$ 19.99	<b>FCP-107-G</b>
5 lb.	89.99	<b>FCP-507-G</b>
25 lb.	419.99	<b>FCP-2507-G</b>

# tech tips

from the techxperts™

It is essential that you measure residual magnetism when using magnetic crack inspection. Magnetic fields are measured in gauss and the gauge used to measure it is a magnetic field indicator (MFI-10010 below). To see if you have any residual magnetism in your components, simply hold the field indicator close to the part. If it doesn't read "0", you have magnetism.

**Goodson  
exclusive**



FCD-KIT



FCD-HP-KIT

## Magnetic Crack Inspection Kits

Goodson carries a variety of magnetic crack detection methods including these two kits. We include heavy-duty 110V adjustable-leg magnets that are made right here in America. Kits also include lights, magnetic powder atomizers, and fluorescence enhancing safety glasses. All items are also available separately.

Description	Jobber	Order No.	Incl.
Fluorescent Magnetic Crack Detection Kit	\$749.99	FCD-KIT	▼
High Performance Fluorescent Crack Detection Kit	849.99	FCD-HP-KIT	▼
115V Heavy Duty Electronic Crack Detector	649.99	MMP-210	x x
Magnetic Powder Atomizer Assembly	24.99	MM-301	x x
Magnetic Crack Detection Oil Spray*	29.99	MFA-16*	x
AC Blacklight	69.99	GLO-4	x
Fluorescence Enhancing Glasses	19.99	GLO-9940	x x
Compact LED UV Inspection Light Kit	159.99	GLO-400	x
Fluorescent Magnetic Powder 1 lb.	19.99	FCP-107-G	x x

\*Hazardous Goods Fees Apply When Shipped Air



## Small Parts Demagnetizer

Don't jeopardize your engine work! Heat, friction and magnetic particle inspection can cause magnetism to build up in your engine components. If not removed, it will attract ferrous materials in engine lubrication and may cause premature engine failure. This easy to use table demagnetizer is a fast and easy way to ensure that all residual magnetism is eliminated from engine components. Use with the optional Magnetic Field Indicator (MFI-10010) to be sure all remaining magnetism is eliminated.

Description	Jobber	Order No.
Small Parts Demagnetizer	\$84.99	SPD-46
Magnetic Field Indicator	64.99	MFI-10010



GLO-400

## Compact 100W LED UV Crack Inspection Light

- Power comparable to high-intensity 100-watt lamps
- Inspection range of up to 10 feet (3M)
- Compact design fits easily into tight, cramped spaces
- 100 thousand hour LED service life
- Rugged, corrosion-resistant, anodized aluminum lamp body stands up to years of heavy shop use
- Rechargeable lithium-ion battery (included) provides 4 hours of continuous inspection between charges
- Includes AC charger, fluorescence enhancing glasses and lanyard
- Order No. GLO-400 Jobber \$159.99

# Full Service FAST!



"At Goodson, we're always on the lookout for new or improved tools that make engine rebuilding easier. If you have a tool you think we'd be interested in, give us a call."

- Dave, Goodson National Sales Manager; 20 yrs. of service

CYLINDER HEAD REBUILDING  
CLEANING, ASSEMBLY & SAFETY  
SHORT BLOCK REBUILDING  
CRANKSHAFT/ FLYWHEEL GRINDING  
MISCELLANEOUS TOOLS & SUPPLIES  
BRAKE & TIRE CHANGING TOOLS  
MEASURING TOOLS  
V-TWIN & METRIC HARD PARTS

Identify surface cracks in minutes!

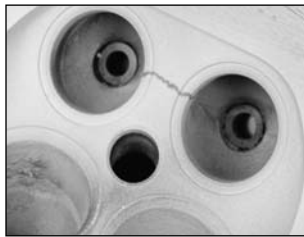

## Alumni-Chek

- Find surface cracks on aluminum & cast iron without electricity or special lights
- Ideal for aluminum, but also works on brass, cast-iron, steel, carbide, and stellite • Even the tiniest cracks show as bright red • Complete kit includes Cleaner, Penetrant, Developer and Shop Towels (also available separately)

Description	Jobber	Order No.	Incl.
Complete Kit	\$46.99	AC-KIT*	▼
Cleaner Aerosol	19.99	AC-1*	x
Penetrant Aerosol	19.99	AC-2*	x
Developer Aerosol	19.99	AC-3*	x
5 Towels	3.99	WST-5	x

Mix or match Cleaner, Penetrant & Developer to make a case of 12 and SAVE 10% OFF Jobber!

\*Hazardous Goods Fees apply when shipped by air



## tech tips

from the techxperts™

**GLO-1:** Spray cleaner evenly on the surface and allow it to dry completely.

**GLO-2:** Spray on Penetrant. Allow to saturate for 5 minutes. Wipe off excess to avoid false readings.

**GLO-3:** Spray on thin layers of developer to build up a uniform powdery film.

**GLO-4:** Flaws and cracks will glow brightly when viewed under the black light.



## GOODSON Glow Blacklight Crack Detection Kit

- Easily detect surface cracks that could easily be missed with just visual inspection
- Cracks & flaws glow brightly under black light after treatment with Cleaner, Penetrant and Developer

Description	Jobber	Order No.	Incl.
Goodson Glow Kit	\$129.99	GLO-KIT*	▼
Cleaner Aerosol	19.99	GLO-1*	x
Penetrant Aerosol	23.99	GLO-2*	x
Developer Aerosol	27.99	GLO-3*	x
110V Blacklight	69.99	GLO-4	x
5 Cloth Towels	3.99	WST-5	x
Replacement Bulb for GLO-4	39.99	GLO-4-B	

Mix or match Cleaner, Penetrant & Developer to make a case of 12 and SAVE 10% OFF Jobber.

\*Hazardous Goods Fees apply when shipped by air



## tech tips

from the techxperts™

Keep all Ultra-Violet and Black Lights a minimum of 18" from magnetic fields to prevent damage to the tungsten element and voiding the warranty.



## Ultra-Violet Light Inspection

- Put into a running engine to find hidden leaks
- Check engines, transmissions and radiators **IN** the vehicle
- Use before disassembly to plan repairs • Use after rebuilding to ensure satisfaction, or to find and fix warranty complaints
- Add dye to oil, coolant or fluid • No pre-cleaning
- Run vehicle briefly to distribute the dye • Inspect with UV light • Finds even the tiniest of leaks

Description	Jobber	Order No.
Light	150W-110VAC light assembly	\$547.99 GLO-300
Replacement	150W-110VAC bulb only (Model 1610)	169.99 GLO-150WB
Bulbs	120W-110VAC bulb only (Model 1210)	169.99 GLO-120WB
Lens	Ultra-violet lens	59.99 GLO-LENS
Dye	Oil Dye for gasoline engines (1 fl. oz.)	10.99 GLO-GED

## Crack Detection Powders and Sprays

- For wet method crack detection
- Mix powder with oil carrier
- Use GLO-300 Light (left) to view results

	Size	Jobber	Order No.
Powder	4 oz.	\$ 49.99	GCR-14A-4
	1 lb.	184.99	GCR-14A
Oil Carrier	5 gal.	134.99	GCR-50



## Magnetic Crack Detection Oil

- Oil impregnated with magnetic powder (GCR-14) to glow under black-light • Low viscosity
- Flows easily into small cracks
- Oil clarity makes cracks easier to see

Description	Jobber	Order No.
Aerosol* 16 oz.	\$ 29.99	MFA-16*
5 gallon /18.93 liter	157.99	MFA-50

\*Hazardous Goods Fees Apply When Shipped Air

## Threaded Crack Repair Plugs

- Iron • Tapered • Threaded plugs
- Cast to rigid specifications

Plug Size	Qty.	Jobber	Order No.
.200" x 1/8"	100	\$104.99	CRP-200
.200" x 1/2"	100	104.99	CRP-201
.235" x 1/8"	100	104.99	CRP-235
.327" x 1/8"	50	104.99	CRP-327



## High Speed Steel Drills

- 118° points for fast chip removal

Plug Size	Jobber	Order No.
.200"	\$6.29	CRD-200
.235"	6.29	CRD-235
.327"	6.29	CRD-327

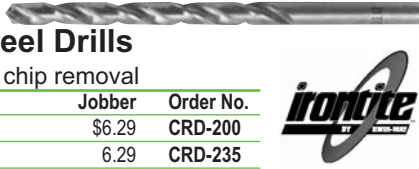

## Tapered Reamers

- High Speed Steel

Plug Size	Jobber	Order No.
.200"		Not Required
.235"	\$ 78.79	CRR-235
.327"	115.49	CRR-327



## Tapered Taps

- High strength steel machined to match plug taper & thread

Plug Size	Jobber	Order No.
.200"	\$66.29	CRT-200
.235"	60.79	CRT-235
.327"	80.49	CRT-327



## Ceramic Motor Seal

- Permanently seals leaking head gaskets, cracked heads and blocks (aluminum or cast iron)
- Coats the engine to inhibit rust formation and salt water corrosion during normal operation
- Seals porous castings in the cooling system
- Stops coolant leaks
- Promotes heat dissipation for added power
- 16 oz./455 mL
- Order No. **CRS-16** Jobber \$18.99

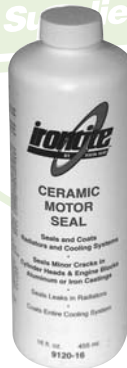

## Rust Inhibitor for Pressure Testing

- Clear fluid inhibits rust and does not discolor or cloud the test tank solution
- Lets you see better to pressure test
- Biocide and anti-rust additives extend tank solution life while preventing corrosion
- Synthetic formula
- Mix 20:1 with water
- Yields 20 gallons
- Order No. **PRI-10** Jobber \$29.99



## .235" Crack Repair Kit

- For the cold-repair process • Includes manual

Description	Jobber	Order No.	Incl.
Complete Repair Kit:	\$367.49	CRK-150	▼
100 - .235" x 1/8" Threaded Iron Plugs	104.99	CRP-235	x
High Strength Steel Drill	6.29	CRD-235	x
High Strength Steel Tapered Reamer	78.79	CRR-235	x
High Strength Steel Tapered Taps (2)	60.79	CRT-235	x
Cut-Off Saw with Blade	25.29	CR-SAW	x
Replacement Saw Blade	9.49	CR-BLADE	x
7.5 oz. Tap Oil	15.79	TAP-O	x
All Weather Seal	17.99	AWS-16	x
16 oz. Ceramic Seal	18.99	CRS-16	x



## Jet Valve Eliminator Kit

- Some Mitsubishi/Chrysler 2.6L heads had jet valves while some didn't
- This kit lets you use a jet valve equipped head in place of one without
- 11mm diameter, 1.0 pitch threaded plugs replace entire valve body assembly
- Easier than welding the holes closed
- Package of 4 converts one 2.6L head
- Order No. **JVE-26** Jobber \$26.99



## Head-Bolt Hole Clean-out Taps

- Clean threaded holes to prevent false torque wrench readings
- Lifts rust, dirt, chips and other debris as you remove the tool
- Use with lube and a socket wrench or slow drill
- Repairs minor damage
- New sizes are ideal for LS Engines



Size	Pitch	Length	Jobber	Order No.
1/2"	13	3 3/8" OAL	\$ 49.99	BCT-1/2
7/16"	14	3 3/8" OAL	49.99	BCT-7/16
10mm	2.0mm	8" Shank	<b>new</b> 129.99	BCT-10X2L
11mm	1.5mm	8" Shank	114.99	BCT-11L
11mm	2.0mm	8" Shank	<b>new</b> 129.99	BCT-11X2L

**PROBLEM:** Due to poor lubrication, the rear bushing on the upper balance shaft of Mitsubishi built Chrysler 2.0L engines galls to the shaft and spins. Repairing the damaged bore is costly and often requires another block.

**SOLUTION:** This kit eliminates both balance shafts so the original block can be reused, saving money and ending future shaft problems. It also reduces total friction and improves oil flow to the head. Some vibration may occur at idle, but engine operation is unaffected by balance shaft removal.



## Balance Shaft Eliminator Kits For Mitsubishi-Built Engines

- Includes 2 bushings (44 & 45mm), oil pump plug & welch plug • Order No. **BSE-20** Jobber \$36.99

CYLINDER HEAD  
REBUILDING

CLEANING,  
ASSEMBLY & SAFETY

SHORT BLOCK  
REBUILDING

CRANKSHAFT/  
FLYWHEEL GRINDING

MISCELLANEOUS  
TOOLS & SUPPLIES

BRAKE & TIRE  
CHANGING TOOLS

MEASURING  
TOOLS

V-TWIN & METRIC  
HARD PARTS

From our customers:



"Our Top Alcohol Dragster cylinder heads have about a zillion studs of various sizes. With the Goodson Stud Remover and Installer, we now make short work out of this very tedious process."

- Dean Dubbin, DFM Awnings (NHRA Top Alcohol Dragster), Goodson customer since 2010

CYLINDER HEAD REBUILDING

CLEANING, ASSEMBLY & SAFETY

SHORT BLOCK REBUILDING

CRANKSHAFT/ FLYWHEEL GRINDING

MISCELLANEOUS TOOLS & SUPPLIES

BRAKE & TIRE CHANGING TOOLS

MEASURING TOOLS

V-TWIN & METRIC HARD PARTS

shown actual size



melted center reveals overheating



## Heat Tabs

- Provides visual evidence of engine overheating
- Special heat sensitive metal centers melt and fall out when engine exceeds the melting point of the tab
- Marine Heat Tabs are sold in packs of 50, all others are 100 per pack
- Attach to heads with Heat Tab Adhesive (below)

Description	Melting Point	Jobber	Order No.
Automotive Heat Tabs	255-260° F / 124-127° C	\$42.99	RHT-100 <b>new</b>
Round Heat Tabs	255-260° F / 124-127° C	52.49	HT-100RD
Diesel Heat Tabs	225-235° F / 107-110° C	52.49	DHT-100
Marine Heat Tabs	187-192° F / 86-89° C	59.99	MHT-50
Heat Tab Adhesive (3 oz./88.7mL tube)		8.99	HTA-3

**tech tips**  
from the techxperts™

## Protect yourself from unjustified warranty claims with a simple Heat Tab

When you attach a heat tab to the engine it provides visual evidence that an engine has been overheated. A special heat sensitive metal has been formed into the center of the tab. When an engine reaches the tab's melting point, this metal will melt and flow out. This is a positive method of determining that a rebuilt engine has been heated beyond normal operating temperature, voiding the warranty.

Attach a Heat Tab to the upper portion of the block or to the cylinder head casting with **HTA-3** Aluminum Paste (above). DO NOT attach to manifolds or shielding.

## Leak Detection Mat

- Commercial-grade Neoprene
- Resists petroleum products, abrasion, swelling, sunlight and aging
- Repair worn mats or make custom leak detection plates
- Measures 3'x4'x $\frac{1}{8}$ " thick (914.4x1219.2x3.175mm)
- Order No. **LDP-34MAT** Jobber \$87.99



## Seal-All™

- Seals pin holes, porosity and small cracks in heads & blocks
- Penetrates and seals
- Out-performs ceramics
- Bonds with existing rust & corrosion to prevent spread
- Heat at 175°-200°F (79.4°-93.3°C) for 4 hours to cure
- Not for use on assembled engines
- 32 oz. (46 mL)
- Order No. **CPS-32** Jobber \$69.99



## Fluid Weld®

- For cast iron or aluminum heads and blocks
  - Use as a sealant for threaded or press-fit parts like valve guides and seats, threaded crack repair plugs, replacement studs, etc.
  - Seals small cracks
  - Non-toxic
  - Non-flammable
  - Not for use on assembled engines
  - Withstands temperatures up to 3000° F
- | Size             | Jobber   | Order No. |
|------------------|----------|-----------|
| 2 oz. (59 mL)    | \$ 44.99 | FW-2      |
| 8.8 oz. (260 mL) | 137.99   | FW-88     |



## All Weather Seal

- Seals intakes & head gasket leaks
- Seals cracks in cylinder heads & engine blocks
- Prevents anti-freeze seepage through gaskets and hoses
- Lubricates water pump seals
- Mixes with all anti-freeze and coolant
- Works in less than 5 minutes
- Fast-acting, non-corrosive, non-clogging
- Can be used with coolant or anti-freeze
- 16 oz./455 mL • Order No. **AWS-16** Jobber \$17.99



For use in a running engine!

## Engine Seal Tabs Seal And Prevent Leaks In Any Cooling System

- Use in a running engine
- For water leaks in cylinder heads, blocks, radiators, water pumps, heater cores, manifolds, etc.
- 3 $\frac{1}{2}$  gram tablets treat up to a 9 quart cooling system
- 20 tabs per pack
- Order No. **EST-10** Jobber \$29.99





Lock the fixture to your mill bed using your standard T-Bolts (not included)

Two towers secure to the mill bed and support the cradle assembly

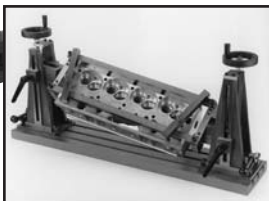

## Vertical Mill Heavy-Duty 360° Roll-Over Fixture

- Uses the Universal Quick-Mount Bar Set (included) to hold the workpiece securely in place
- Position workpieces quickly & accurately
- Locks to your table using your standard T-nuts
- Handles workpieces up to 24" long
- Cradle accommodates inline and canted valves with offset movement up to 15°
- Width adjusts in ¼" increments • Instructions included
- Quick-Mount Bar Set can also be used as a replacement on most popular seat & guide machines

Description	Jobber	Order No.
Roll-Over Fixture with Quick-Mount Bar Set	\$1,999.99	VM-42
Replacement Quick-Mount Bar Set	159.99	QMB-95

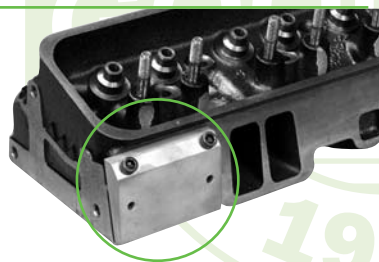

## GM Vortec Adaptor Plate Set For Van Norman & Storm-Vulcan Rotary Broaches

- Required when using the Van Norman VN 530 / 570 or Storm-Vulcan 850 Storm-Mill Rotary Broaches
- Two plate set • Includes fasteners
- Order No. **VN-VOR** Jobber \$99.99



## Chevy Conversion Plate Set

- Convert early model, 6-bolt heads for late model, 7-bolt applications
- Works with stock exhaust systems
- Use the standard exhaust manifold gasket or seal with High-Temp Silicone
- Order No. **CHC-10** Jobber \$26.99

## Installation

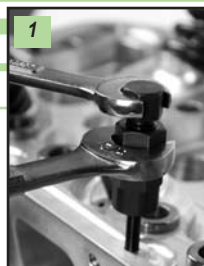

1 - Insert stud into correct size installer.



2 - Hand set the stud into the cylinder head



3 - Use a standard ¾" wrench or socket to tighten stud into place. Each installer is fitted with a steel ball inside to prevent over-tightening.

## Removal



1 - Place the remover over the stud to be removed. Using 2 wrenches, back the stud out of the head.

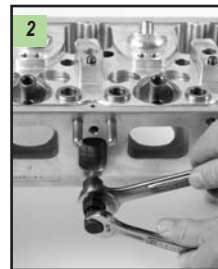

2 - Removers can be used in virtually any position.



## Stud Removal and Installation Tooling

- Size stamped for easy identification • Installers include a steel ball inside to prevent overtightening on the stud
- Removers have a ¾" OD Hex body with a ½" hex jam nut on top • Storage case included with kit
- Available individually or in sets

Description	Jobber	Order No.
Stud Installer Set	\$149.99	ASI-7KIT
¼" Fine	21.99	ASI-250 x
5/16" Fine	21.99	ASI-312 x
3/8" Fine	21.99	ASI-375 x
7/16" Coarse	21.99	ASI-375C x
7/16" Fine	21.99	ASI-437 x
1/2" Fine	21.99	ASI-500 x
9/16" Fine	21.99	ASI-562 x
Stud Remover Set	\$199.99	ASR-7KIT
¼" Fine	29.99	ASR-250 x
5/16" Fine	29.99	ASR-312 x
3/8" Fine	29.99	ASR-375 x
7/16" Coarse	29.99	ASR-375C x
7/16" Fine	29.99	ASR-437 x
1/2" Fine	34.99	ASR-500 x
9/16" Fine	34.99	ASR-562 x

See Dean Dubbin's product testimonial on page 52



## Smog Plugs

- Replace smog plugs damaged during head cleaning process

Application	Thread	Jobber	Order No.
Chevy 2.5L, 4.1L	¾" x 18	\$4.49	EMP-15
Ford 302, 351	5/8" x 11 (outside), 7/8" x 14 (inside)	4.49	EMP-34



"We reward you for prompt payment! You can get a 1% discount on merchandise if payment is made within 15 days of the invoice date. Just check the bottom left corner of your invoice for the prompt payment discount."

- Roger, Goodson Controller, 15 years of service

CYLINDER HEAD  
REBUILDING

CLEANING,  
ASSEMBLY & SAFETY

SHORT BLOCK  
REBUILDING

CRANKSHAFT/  
FLYWHEEL GRINDING

MISCELLANEOUS  
TOOLS & SUPPLIES

BRAKE & TIRE  
CHANGING TOOLS

MEASURING  
TOOLS

V-TWIN & METRIC  
HARD PARTS

## Aluminum Cylinder Head Straightening Fixture

- Straightens aluminum heads warped up to .040", returning them to  $\pm .005$ " of the original • Easy to use • Mehonite fixture is rigid as 3" steel yet weighs less • Stress-relieved then milled to .001"
- Can resurface fixture if necessary • Includes shim stock and all hardware • 29"L for 4-cylinder & most 6-cylinder
- Order No. **HSF-500** Jobber \$299.99

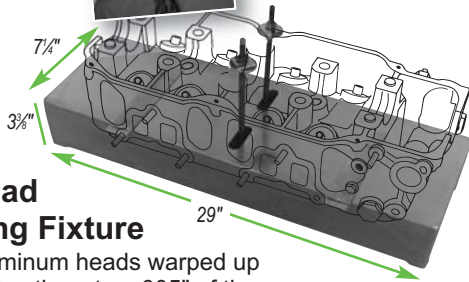

Buy 3 crayons,  
get 10% off jobber

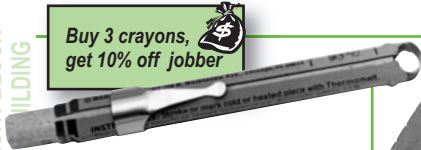

## Temperature Indicating Crayons

- Mark the workpiece before heating
- Crayon melts when temp is reached
- 3 temps to choose from

Melting Point	Jobber	Order No.
450°F/232.22°C	\$17.99	<b>TIC-450</b>
500°F/260.00°C	17.99	<b>TIC-500</b>
600°F/315.56°C	17.99	<b>TIC-600</b>

## Gauntlet Style Heat & Flame Resistant Gloves

- Heavy, lined red terrycloth
- Safe to 450°F / 232.2°C
- 13 1/2" Long
- Order No. **HRF-300** Jobber \$29.99



Pre-drilled mounting flanges to securely mount the oven in position



Interior capacity of 35" x 15" x 15" is large enough to accommodate most heads. Shown with our Head Straightening Fixture (sold separately).



## Electric Benchtop Aluminum Head Straightening Oven

- Reaches temps up to 550°F / 287.8°C making it ideal for straightening aluminum heads and pre-heating for welding
- MIG welded 10 gauge steel housing • Electric heating coils
- 220V, 60 Hz single phase • 2 hour automatic shut-off timer
- Cabinet measures 40"W x 30"H x 21"D
- Interior dimensions: 35"W x 15"H x 15"D
- Use with our straightening fixture above, left
- 1-year warranty on heating element
- Ready to be hard-wired into your shop's electrical service

Description	Jobber	Order No.
Aluminum Head Straightening Oven	\$2,199.99	<b>DHR-34</b>
Heating Element	89.99	<b>DHR-34E</b>
Thermostat Control Unit	169.99	<b>DHR-34T</b>

## Precision Steel Straight Edges

Description	Jobber	Order No.
24" straightedge, 1 precision edge	\$ 74.99	<b>PSE-24</b>
36" straightedge, 1 precision edge	94.99	<b>PSE-100</b>
24" straightedge, 2 precision edges	162.79	<b>DIS-20</b>
35" straightedge, 2 precision edges	176.49	<b>DIS-30</b>

## 26" Round Warp Gauge

- Use with feeler gauges page 55

Description	Jobber	Order No.
3/4" dia. tool steel, 26" long	\$139.99	<b>EWG-100</b>

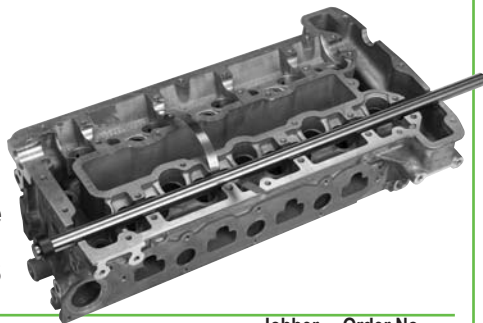

## Brass or Steel Shim Stock Packs

- A handy assortment • 4" x 6" each (120 sq. in.)
- One each of .001", .002", .003", .005", .010" thick

Description	Jobber	Order No.
Brass	\$12.99	<b>SSB-50</b>
Steel	12.99	<b>SSS-51</b>

Use with our Head Straightening Fixture and Oven above



# Miscellaneous Cylinder Head

Buy 5 or more packs of VADs (any combination of sizes), Save 10% off Jobber



## Adjust Clearance Between Valve Stem and Cams with Valve Adjustment Discs



- Ideal for most import engines
- To select the Valve Adjustment Disc for your job consult the Manufacturer's Specifications for the correct diameter and thickness

Diameter	Thicknesses included	4-Packs of Individual Sizes	
		Jobber	Order No.
28mm	2.50, 2.55, 2.60, 2.65, 2.70, 2.75,	\$16.99	VAD-(thick)MM-28
	2.80, 2.85, 2.90, 2.95, 3.00, 3.05,		
	3.10, 3.15, 3.20, 3.25, 3.30		
34mm	2.20, 2.25, 2.30, 2.35, 2.40, 2.45,	16.99	VAD-(thick)MM-TY
	2.50, 2.55, 2.60, 2.65, 2.70,		
	2.75, 2.80, 2.85, 2.90, 2.95, 3.00, 3.05, 3.10, 3.25, 3.30		

VADs are NOT sold by application, but by diameter and thickness. Please consult manufacturer's specifications before ordering.

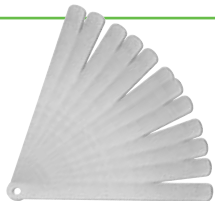

## 12" Feeler Gauges

- Use to measure piston-to-wall clearance when honing, to find ring end gap and to check cylinder heads with a straight-edge
- Also useful for shimming while straightening heads and for machine set-ups

	Jobber	Order No.	
Complete Kit	\$39.99	FE-KIT	▼
Thick .0015"	5.99	FE-0015	x
.0020"	5.99	FE-002	x
.0030"	5.99	FE-003	x
.0040"	5.99	FE-004	x
.0050"	5.99	FE-005	x
.0060"	5.99	FE-006	x
.0070"	5.99	FE-007	x
.0080"	5.99	FE-008	x
.0090"	5.99	FE-009	x
.0100"	5.99	FE-010	x
.0150"	5.99	FE-015	x
.0200"	5.99	FE-020	x

## Universal Gel Lube

- Sprays on as a liquid and forms into a gel within seconds
- Penetrating formula blends with motor oil
- Originally developed for valve spring break-in, but can also be used for cams, lifters, rocker arms, bearings, pistons/wrist pins, cylinders, etc.
- Provides lubrication for engines subjected to prolonged storage before initial start-up
- Aerosol\* • Order No. **GL-8U** Jobber \$17.99
- \* Hazardous Goods Fees Apply If Shipped Air

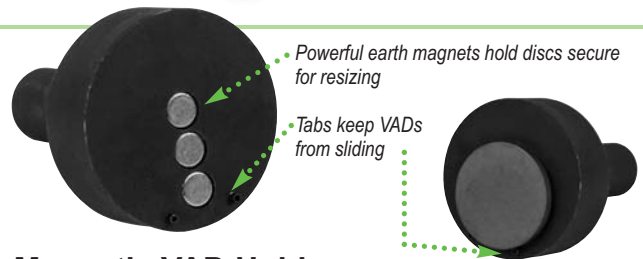

- Powerful earth magnets hold discs secure for resizing
- Tabs keep VADs from sliding

## Magnetic VAD Holder

No more waiting for a special size – take an existing VAD and grind it to the size you need right on your valve refacer. Powerful magnets hold the VAD securely while you resize them. Tabs keep the VADs from sliding off the holder while grinding. Order No. **VDR-UNI** Jobber \$79.99  
Replacement Magnet **VDR-MAG** Jobber \$5.99

## Resize VADs at your shop quickly and easily

**tech tips**  
from the techxperts™

Has this happened to you? You're adjusting the clearance between the valve stem and the cams and the stock Valve Adjustment Disc (VAD) isn't the right thickness. You need a 2.25 in a 28mm diameter and the thinnest ones available are 2.50. What are you going to do?

You could wait to have them resized by your supplier, but hey, you're a machinist! You have all of the tools and abilities right in your shop to modify the VADs you have into the VADs you need.

Place the VAD that you need to resize on your Magnetic VAD Holder (**VDR-UNI**, above). The powerful earth magnets will hold it securely. Using your Valve Grinder's stem end wheel, grind the VAD to the thickness you need. You're now ready to install it in the head. All in a few minutes instead of a few days.



## VAD Adjusting Tools For Toyota

- Reach around the cam to depress the lifter
- Wedge holds the lifter down to free the valve clearance disc
- Reach in to remove and replace the disc
- For most models prior to 2004

Description	Jobber	Order No.
Pliers and Wedge	\$39.99	<b>VBT-40</b>
Wedge only	14.99	<b>VDL-20</b>

## Spray Assembly Lube

- Ideal for prelubricating parts to ease assembly
- Eliminates critical initial run-in of new and rebuilt high-performance engine components
- Spray on bearings, crankshafts, pistons, rings, etc.
- Aerosol\* • Order No. **SAL-11** Jobber \$11.99
- \* Hazardous Goods Fees Apply If Shipped Air



Buy 6 or more cans of GL-8U and SAL-11 (any combination) and save 10% off jobber.



CYLINDER HEAD REBUILDING

CLEANING, ASSEMBLY & SAFETY

SHORT BLOCK REBUILDING

FLYWHEEL GRINDING

CRANKSHAFT/ MISCELLANEOUS TOOLS & SUPPLIES

BRAKE & TIRE CHANGING TOOLS

MEASURING TOOLS

V-TWIN & METRIC HARD PARTS



"When you call Goodson, you speak to a person, not a machine. We work hard to make sure we answer your calls promptly and avoid keeping you on hold."  
- Katie, Goodson Afternoon Receptionist, 1 year of service

S-373P  
Pilot shown installed

CYLINDER HEAD REBUILDING  
CLEANING, ASSEMBLY & SAFETY  
SHORT BLOCK REBUILDING  
CRANKSHAFT/ FLYWHEEL GRINDING  
MISCELLANEOUS TOOLS & SUPPLIES  
BRAKE & TIRE CHANGING TOOLS  
MEASURING TOOLS  
V-TWIN & METRIC HARD PARTS

## Manual Rocker Arm Stud Puller

- Heavy-duty ball bearing action
- Creates less stress and friction
- Fits 5/16" (7.9mm) and 3/8" (9.53mm) threaded studs
- Not recommended for use on thermally cleaned heads

Description	Jobber	Order No.
Complete Stud Puller	\$119.99	SP-600
Drive Nut	23.99	SP-601
Puller Body	49.99	SP-602
5/16" and 3/8" Mandrel	49.99	SP-603
Thrust Bearing	11.99	SP-604



## Rocker Arm Stud Conversion Kit

- Convert pressed-in rocker arm studs to threaded studs
- Remove stud, face stud boss, then drill and tap the stud hole
- Use with a seat and guide machine

Description	Jobber	Order No.	Incl.
Conversion Kit	\$104.99	S-450-KIT	▼
Stud Boss Facer	89.99	S-450-F	x
3/8" Drill Bit	11.79	S-373D	x
7/16" x 14 Thread Tap	19.99	S-437T	x
3/8" Pilot	20.99	S-373P	x
2 Pc. SB V8 Chevy Tap Guide	39.99	S-350G	



## Universal Threaded Stud Extractor

- Use with your pneumatic impact tools & sockets (1 1/16" socket removes, 1 1/16" installs)
- Requires only 3/4" clearance to adjacent studs
- For threaded studs only
- Hardened 3-jaw clamping system
- Internal taper support
- Hollow body allows long studs to extend through the tool
- 1 1/2" dia. x 2 1/2" long • 1/4" - 1/2" range

Description	Jobber	Order No.
Universal Stud Extractor	\$149.99	PSR-500
Replacement Parts		
Jaws	104.99	PSR-JAWS
Spring Set	5.99	PSR-3S
Snap Ring	3.99	PSR-SR



## Torque-Angle Indicator

- When torque is given as degrees of turn past a certain ft./lb., use this gauge to show degrees
- Hold metal base with one hand
- Plastic dial turns as you tighten
- Fits between a socket-driven extension and the socket
- 1/2" square drive
- Order No. **TQR-4554** Jobber \$19.99



## Mercedes .015" Head Saver Shims

- Shim cam towers if more than .015" is removed when resurfacing head
- Restores valve clearance & timing
- For 4, 5 & 6-cylinder Mercedes gas or diesel engines
- Each set shims all cam towers in one head
- Order No. **MHS-40** Jobber \$12.99



## Head Bolt Spot Facer

- Spot face head bolt seat parallel to new deck surface after angle milling
- Allows proper head bolt torquing
- Cutting tip radius matches OE design to avoid stress points and cracks
- .468" shank with flat

Description	Jobber	Order No.
Spot Facer	\$99.99	HBF-15
7/16" Pilot	14.99	GFP-437

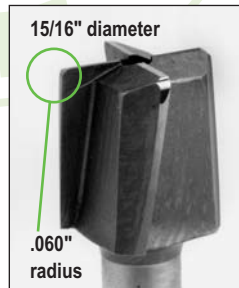

## Rocker Arm Pedestal Shims

- Compensate rocker arm/push rod distance after head/block machining
- Use original rocker arm specs
- .020" thick

Application	Qty.	Jobber	Order No.
Ford 302/351	50	\$12.79	RASF-20-50
Ford 302/351	100	20.99	RASF-20-100
GM 3.1L, V6	50	12.79	RASG-20-50
GM 3.1L, V6	100	20.99	RASG-20-100

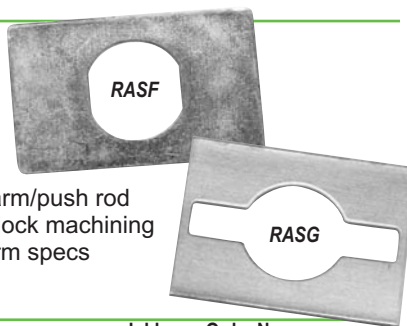

## Two Blade Spot Facer

- 1 1/4" OD Spot Facer located on 3/8" stud
- Removes unneeded material for easier removal and installation of screw-in studs
- Replaceable carbide blades

Description	Jobber	Order No.	Incl.
Stud Boss Facer	\$129.99	SBF-5587	▼
Stud Boss Facer Tip (each) for SBF-5587 only	19.99	SBF-5587T	x
Stud Boss Facer Screw (each)	5.99	SBF-5587S	x
Replacement Stud Boss Facer 3/8" Pilot (optional)	27.99	SBF-5587P	

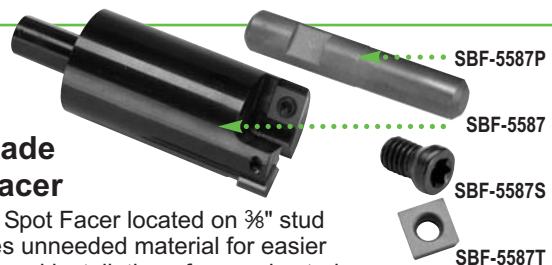

More Stud Boss Facers on page 34

# Head Holders and Stands

## Economy Cylinder Head Holder

- Holds head with either side up
- Tapered pins fit any size head bolt hole and loosen with a twist
- Ideal for guide sizing with ample clearance to remove arbors and reamers
- All steel construction
- Two piece set
- Order No. **HH-100-G** Jobber \$27.99

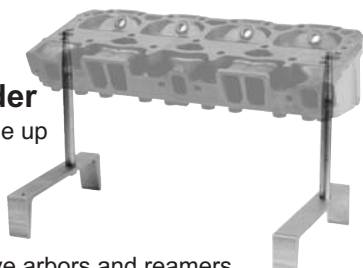

## Ultra-Sturdy Cylinder Head Holder

- 360° stand holds head securely in position
- Tie-rod to prevent tipping
- Slip-resistant neoprene covered rails
- Fits domestic, foreign, truck & motorcycle heads
- 3-piece set
- Order No. **HH-450** Jobber \$99.99

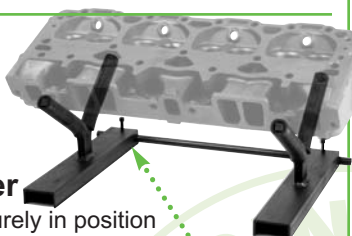

Set screws hold the two pieces firmly in place

## Universal Cylinder Head Holder

- Accommodates all types of cylinder heads
- Sturdy, durable, lightweight aluminum construction
- Slip-resistant neoprene covered rails
- Place heads quickly into any position and rotate them easily through 360°
- Requires no bolts, clamps or adaptors
- 2 piece set • Order No. **HH-200** Jobber \$119.99

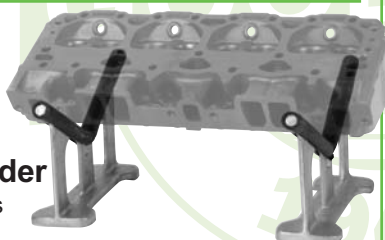

## Professional Measuring & Inspection Stand

- Length adjusts up to 23"
- Rotate work to view or measure
- Solid aluminum frame with self lubricating, corrosion and chemical-resistant wear surfaces
- Order No. **PMIS-30** Jobber \$124.99

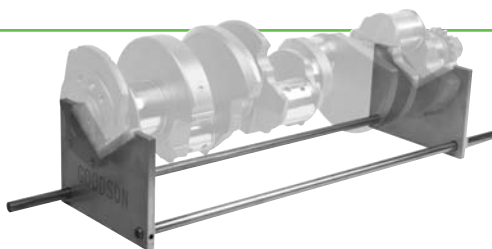

**Goodson**  
EXCLUSIVE

## Steel Double Harley Head Plate

This Double Head Plate takes the universal design of our **HHP-6** Head Plate one step further to accommodate two heads at the same time. Due to its unique mounting system, it fits Shovel, Evolution, Twin Cam, V-Rod, Sportster and Pan heads. The plate is heavy enough for cutting and installing guides and seats. It is designed to be used on a seat and guide machine or Bridgeport-type Mill, including CNC machines. Mounting instructions (with diagrams) for all head types are included. Blackened steel construction. Order No. **HHP-26** Jobber \$749.99



**PRICE CUT**

**Goodson**  
EXCLUSIVE

## Steel Harley® Head Plate and Head Stand

- Fits Shovel, Evolution, Twin-Cam, V-Rod, Sportster and Pan heads
- Rigid enough for cutting and installing guides and seats
- Adjustable positive stops for leveling and machining
- Use on seat and guide machine and/or head resurfacer
- Includes 2 risers
- Instructions include easy-to-read diagrams for mounting Harley® heads
- Blackened steel

Plate swivels a full 45° either way and is lockable anywhere in between



Description	Jobber	Order No.	Incl.
Complete Unit	\$699.99	<b>HHS-600</b>	▼
Head Stand	399.99	<b>HHS-601</b>	x
Head Plate	389.99	<b>HHP-6</b>	x

## Intake Scribe Ring Kit

- For porting Evo & V-Twin engines (98-07)
- Kit includes 2 flanges, 1 sealing ring and 1 scribe ring
- Easy as 1-2-3
- 1-Bolt to intake port, 2-Scribe around ring, 3-Port to scribe marks
- Optional D-Ring for exhaust port scribing on Evo & V-Twins (98 - 04)

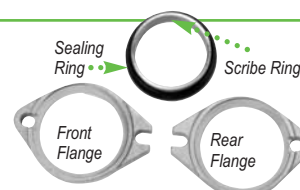

Description	Jobber	Order No.
Intake Scribe Ring Kit	\$64.99	<b>HSR-1650KIT</b>
D-Ring for Exhaust Port Scribing	19.99	<b>HSR-1625D</b>

CYLINDER HEAD REBUILDING  
CLEANING, ASSEMBLY & SAFETY  
SHORT BLOCK REBUILDING  
FLYWHEEL GRINDING  
CRANKSHAFT/ MISCELLANEOUS TOOLS & SUPPLIES  
BRAKE & TIRE CHANGING TOOLS  
MEASURING TOOLS  
V-TWIN & METRIC HARD PARTS



"Hablamos español. Para su conveniencia tenemos representantes bilingües que le puedan ayudar con su orden." - Veronica, Ventas y Servicio, 1 año de servicio

CYLINDER HEAD REBUILDING  
CLEANING, ASSEMBLY & SAFETY  
SHORT BLOCK REBUILDING  
CRANKSHAFT/ FLYWHEEL GRINDING  
MISCELLANEOUS TOOLS & SUPPLIES  
BRAKE & TIRE CHANGING TOOLS  
MEASURING TOOLS  
V-TWIN & METRIC HARD PARTS

**Aluminum Oxide Cloth Utility Shop Rolls**

- 1" x 50 yards
- Easy to use ... just unroll and tear to length
- Use with butterfly mandrels at right

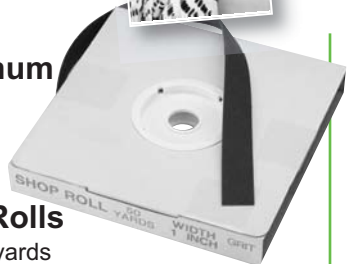

Grit	Jobber	Order No.
60	\$20.99	UR-1-60
80	23.29	UR-1-80
100	20.99	UR-1-100
120	20.99	UR-1-120
180	20.99	UR-1-180

**Crocus Cloth**

- Must be used with Lapping Oil
- Great for final touch-ups on cranks, rod pins, valve stems, cams, etc.
- Use with slotted mandrels at right



Description	Jobber	Order No.
1" x 50 yd. Roll	\$38.99	UR-1-CROCUS
8 oz. Lapping Oil	17.99	LP-LO-8

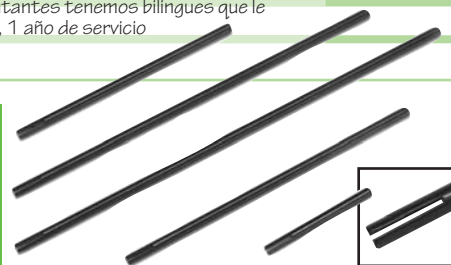

**Slotted Butterfly Mandrels**

- Use with roll abrasives such as those at left
- Several lengths available

Length	Jobber	Order No.
3"	\$ 5.29	BM-3
6"	9.99	BM-6
8"	10.49	BM-8
10"	13.79	BM-10
12"	16.79	BM-12

**Replacement Abrasive Packs and Mandrels**

**Abrasive Grinding Discs (Quick Change)**



Box of 50	Dia.	Grit	Jobber	Order No.
1 1/2"	80	\$26.29	AGD-15-80	
2"	80	25.29	AGD-2-80	

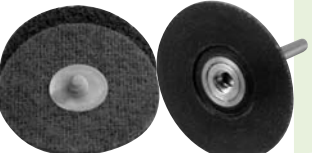

**Replaceable Roll Lock Discs**  
10 per pack. Kit include holder & 1 pad.

Desc.	Jobber	Order No.	Incl.
2" Kit	\$15.99	RLH-2KIT	▼
3" Kit	17.99	RLH-3KIT	▼

Dia.	Jobber	Order No.
2" Medium	\$10.49	RSCD-2M
Coarse	12.99	RSCD-2C
3" Medium	16.79	RSCD-3M
Coarse	20.99	RSCD-3C

Disc Holder	Jobber	Order No.
2" Dia.	\$14.99	RLH-2
3" Dia.	16.99	RLH-3

**Straight Cartridge Rolls**

1 1/2" long, 1/8" hole.  
Box of 50

Dia.	Grit	Jobber	Order No.
1/4"	40	\$24.29	SCR-250-40
80	24.29	SCR-250-80	
120	19.99	SCR-250-120	
3/8"	40	24.29	SCR-375-40
80	24.29	SCR-375-80	
120	24.29	SCR-375-120	
3/2"	40	29.49	SCR-500-40
60	29.49	SCR-500-60	
80	29.49	SCR-500-80	
100	29.49	SCR-500-100	
120	29.49	SCR-500-120	
3/4"	40	57.79	SCR-750-40
80	57.79	SCR-750-80	
120	57.79	SCR-750-120	

**Straight Cartridge Rolls**

1" long, 1/8" hole.  
Box of 50

Dia.	Grit	Jobber	Order No.
1/4"	60	\$18.99	SCR-1-250-60
80	16.79	SCR-1-250-80	

**Half-Tapered Cartridge Rolls**

1 1/2" long, 1/8" hole. Box of 50

Dia.	Grit	Jobber	Order No.
3/8"	40	\$36.79	HTR-375-40
80	37.79	HTR-375-80	
120	39.99	HTR-375-120	
3/2"	40	36.79	HTR-375-320
1/2"	40	37.79	HTR-500-40
80	39.99	HTR-500-80	

**Full-Tapered Cartridge Rolls**

1 1/2" long, 1/8" hole. Box of 50

Dia.	Grit	Jobber	Order No.
3/8"	40	\$26.29	FTR-375-40
80	27.79	FTR-375-80	
120	27.79	FTR-375-120	
3/2"	29.49	FTR-375-320	
1/2"	40	31.49	FTR-500-40
60	29.49	FTR-500-60	
80	30.49	FTR-500-80	
100	41.99	FTR-500-100	
120	30.99	FTR-500-120	
5/8"	40	41.99	FTR-625-40
80	41.99	FTR-625-80	

**Cross Buffs®**

Box of 10

Dia.	Grit	Jobber	Order No.
<b>2-Ply</b>			
3/4"	V. Fine	\$31.49	CB-75VF
	Med.	31.49	CB-75M
1"	V. Fine	31.49	CB-1VF
	Med.	31.49	CB-1M
1 1/2"	V. Fine	31.49	CB-15VF
	Med.	31.49	CB-15M
<b>3-Ply</b>			
1 1/4"	V. Fine	\$41.99	CB-125VF-HD
	Med.	41.99	CB-125M-HD
1 1/2"	V. Fine	41.99	CB-15VF-HD
	Med.	41.99	CB-15M-HD

**Cross Buff® / Flap Wheel**

Mandrel	Jobber	Order No.
4" Mandrel	\$11.99	CB-MANDREL
Set Screw (3)	5.99	CB-SCREW

**Machining Aid**

- Designed for aluminum
- For porting & polishing with cartridge rolls, rotary files, emery cloth or Cross Buffs®
- Safe for cast iron
- 32 oz./946.4mL
- Order No. **PF-32**
- Jobber \$41.99



**Roll Mandrels**

Use with straight and tapered cartridge rolls • 1/8" pilot x 1/4" dia.

Length	Jobber	Order No.
2 3/4"	\$ 8.79	CR-275
4"	9.79	CR-40
6"	10.99	CR-60
8"	13.29	CRM-8H
10"	13.29	CRM-10H
12"	13.29	CRM-12H

**Mirrored Safety Glasses**

- Wrap-around design
- Tinted lenses provide sun glare protection • Universal bridge • Polycarbonate lenses • Do not use as welders helpers
- Order No. **PGL-21**
- Jobber \$4.99



**Abrasive Flapwheels**

1" wide, 1/4" x 20 threaded, 1 each.

Dia.	Grit	Jobber	Order No.
1 5/8"	80	\$11.99	APK-7
2"	80	11.99	APK-8
2 1/2"	80	11.99	APK-9
1"	120	7.99	AFW-1-120
2"	120	8.99	AFW-2-120
3"	120	9.99	AFW-3-120

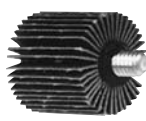

**NOTE: Extreme caution must be used when porting & polishing. Be sure to wear safety glasses.**

# Professional Porting & Polishing Tools



## 35 Pc. Porting & Polishing Abrasives Kit

A great starter kit! This kit includes a sampling of our most popular abrasives including Abrasive Rolls (Spiral and Straight), Flap Wheels, Mounted Abrasive Points, Abrasive Roll Material, Mandrels and instructions.

Description	Jobber	Order No.	Incl.
<b>35 Piece Abrasive Kit</b>	\$62.99	APK-100	▼
<b>Replacement Abrasives</b>	<b>Grit</b>	<b>Qty.</b>	
Full-Taper Spiral Roll, 1/2" x 1 1/2" x 1/8"	80	50	\$54.99 <b>APK-1</b> x
Full-Taper Spiral Roll, 5/8" x 2" x 1/8"	80	50	63.99 <b>APK-2</b> x
Cartridge Roll, 5/8" x 1 1/2" x 1/8"	80	50	44.99 <b>APK-3</b> x
Flap Wheel, 1" x 1" x 1/4"	120	5	36.79 <b>APK-4</b> x
Mounted Wheel, 1/4" shank	60	1	7.99 <b>GM-12</b> x
Roll Mandrel, 1/4" dia., 4" long		1	9.79 <b>CR-40</b> x
Flap Wheel Mandrel, 1/4" x 4"		1	11.99 <b>CB-MANDREL</b> x
Slotted Butterfly Mandrel 3"		1	5.29 <b>CR-30</b> x

## Deluxe Porting Kit

- Complete kit includes: 2 Flapwheels, 4 Cross Buffs®, 7 Full Tapered Cartridge Rolls, 7 Half-Tapered Cartridge Rolls, 21 Straight Cartridge Rolls, 2 Mounted Points, 2 Cartridge Mandrels and 1 Cross Buff® Mandrel with set screws
- Replacement abrasives, pg. 58
- Includes plastic storage case
- Order No. **DPK-100** Jobber \$94.49



## Small Engine Porting Kit

- Complete kit includes: 12 Straight Cartridge Rolls, 8 full Tapered Cartridge Rolls, 4 Half-Tapered Cartridge Rolls, 8 Cross Buffs®, 2 abrasive rolls, 2 Flapwheels, 1 Cross Buff® Mandrel with 2 Set Screws and 2 Roll Mandrels
- Includes plastic storage case
- Replacement abrasives, pg. 58
- Order No. **SEPK-5** Jobber \$65.29

small engine powersports

## Silicon-Carbide Abrasive Rolls with Integral 4" Mandrels

- 4" integral mandrel and solid abrasive core allows you to use up the entire roll before replacing it
- Available in 1/2" and 5/8" diameters • 5 per pack



Dia.	Grit	Jobber	Order No.	Dia.	Grit	Jobber	Order No.
1/2"	60	\$26.29	<b>LSCR-500-60</b>	5/8" dia.	60	\$26.29	<b>LSCR-625-60</b>
	80	29.49	<b>LSCR-500-80</b>		80	29.49	<b>LSCR-625-80</b>

## Quick Change Mandrels & Abrasive Sleeves

- 5 sleeves per pack • 1" x 1"
- Mandrel has 1/4" shaft



Description	Grit	Jobber	Order No.
Mandrel		\$8.99	<b>GMS-101</b>
Sleeves	40	8.99	<b>GMS-140</b>
	60	8.99	<b>GMS-160</b>

## Intake Port Reshaping Kit

- Superior formula uses 2-part epoxy • Won't shrink when dry • Can be milled or machined • Withstands temperatures up to 500°F/ 260°C • Kit includes epoxy, gloves and mixing sticks
- Yields 16 oz./453.6g of material
- Order No. **PRK-99** Jobber \$36.99



from the techxperts™  
Epoxy components are the consistency of a thick paste and must be kneaded together.



## 110V Electric Die Grinder

- 1/4" collet • 8' cord • 110V • 2.5 amp • 25,000 RPM
- Includes 2 collet wrenches
- **Optional Speed Control** lets you vary from 200 to 25,000 RPM • 6' cord • 110V • 15 amp

Description	Jobber	Order No.
25,000 RPM Die Grinder	\$219.99	<b>GEO-600</b>
Variable Speed Control	44.99	<b>GEO-SC</b>



**NOTE:** Extreme caution must be used when porting & polishing. Be sure to wear safety glasses.

CYLINDER HEAD REBUILDING  
CLEANING, ASSEMBLY & SAFETY  
SHORT BLOCK REBUILDING  
FLYWHEEL GRINDING  
CRANKSHAFT/ FLYWHEEL GRINDING  
MISCELLANEOUS TOOLS & SUPPLIES  
BRAKE & TIRE CHANGING TOOLS  
MEASURING TOOLS  
V-TWIN & METRIC HARD PARTS

"When rebuilding several motors at a time, your organizer trays are very important. We love the thought given in the products and how parts remain in important order!"

- George Bernacchi, 88 Tire Shop, via Facebook

CYLINDER HEAD REBUILDING



## Double Cut Carbide Burr Set

- 1/8" diameter shank
- Includes custom wooden storage case and 9 burrs
- 1/4" burrs on 1/8" heat treated steel 1 1/4" long shanks
- Order No. **FR-9KIT** Jobber \$149.99

FR-34-C



FR-45-C



## 1/4" Shank Carbide Rotary Double Cut Files

Dia.	Length	Shank	Jobber	Order No.
1/2"	1 1/8"	1.1"	\$39.99	<b>FR-34-C</b>
3/8"	1"	1.0"	34.99	<b>FR-45-C</b>

CLEANING, ASSEMBLY & SAFETY

SHORT BLOCK REBUILDING

CRANKSHAFT/ FLYWHEEL GRINDING

MISCELLANEOUS TOOLS & SUPPLIES

BRAKE & TIRE CHANGING TOOLS

MEASURING TOOLS

V-TWIN & METRIC HARD PARTS

## Short Long



## Open Fluted Rotary Files for Aluminum

Choose between 2 shank lengths – 1 1/2" and 6" in several sizes. All of the files feature a 1/4" diameter shank

Dia.	Length	Jobber	Order No.	Incl.
<b>1 1/2" Long Shank Kit</b> \$184.99 <b>AFR-KIT</b> ▼				
<b>A</b>	1/2"	1"	49.99	<b>AFR-34</b> x
<b>B</b>	3/4"	1 1/8"	49.99	<b>AFR-45</b> x
<b>C</b>	1/2"	1 1/2"	49.99	<b>AFR-55</b> x
<b>D</b>	3/8"	1"	49.99	<b>AFR-93</b> x
<b>E</b>	3/8"	1 1/8"	49.99	<b>AFR-121</b> x

Dia.	Length	Jobber	Order No.	Incl.
<b>6" Long Shank Kit</b> \$299.99 <b>LAFR-KIT</b> ▼				
<b>A</b>	1/2"	1"	64.99	<b>LAFR-34</b> x
<b>B</b>	3/8"	3/4"	39.99	<b>LAFR-45</b> x
<b>C</b>	1/2"	1 1/8"	57.99	<b>LAFR-55</b> x
<b>D</b>	3/8"	1 1/2"	59.99	<b>LAFR-70</b> x
<b>E</b>	1/2"	1"	59.99	<b>LAFR-93</b> x
<b>F</b>	3/8"	1 1/8"	79.99	<b>LAFR-121</b> x

Save almost 30% when you buy the kit!

## 6" Long Shank Double Cut Carbide Rotary Files

• 1/4" diameter shank

Dia.	Length	Jobber	Order No.	Incl.
<b>Complete 5 Pc. Kit</b> \$199.99 <b>LFR-KIT</b> ▼				
<b>A</b>	1/2"	1 1/8"	49.99	<b>LFR-34C</b> x
<b>B</b>	3/4"	1 1/2"	49.99	<b>LFR-45C</b> x
<b>C</b>	1/2"	1 1/2"	49.99	<b>LFR-55C</b> x
<b>D</b>	1/2"	1 1/8"	49.99	<b>LFR-46C</b> x
<b>E</b>	1/2"	1 1/8"	49.99	<b>LFR-141C</b> x



Order 5 or more Rotary Files, Burrs or Mounted Points (mix & match) and save 10% off jobber

## Carbide Single Cut Rotary Files for Aluminum

- 1/8" heat treated steel shanks
- For all non-ferrous metals
- 1 1/2" shank length (nominal)

Dia.	Cut Length	Jobber	Order No.
1/4"	1/2"	\$16.99	<b>FRA-51F</b>
1/4"	1/2"	16.99	<b>FRA-51C</b>
1/4"	1/2"	16.99	<b>FRA-51A</b>
1/4"	1/4"	16.99	<b>FRA-51E</b>



## 1/4" Shank Mounted Points

- Aluminum-Oxide abrasive is ideal for roughing cast iron • 1 1/2" shank length

Dia.	Length	Grit	Jobber	Order No.
<b>A</b>	3/4"	2 1/2"	60	\$7.99 <b>GM-1</b>
<b>B</b>	3/8"	2 3/4"	60	7.99 <b>GM-3</b>
<b>C</b>	3/8"	1"	60	7.99 <b>GM-11</b>
<b>D</b>	1 1/16"	1 1/4"	60	7.99 <b>GM-12</b>
<b>E</b>	1 1/4"	1 1/2"	60	7.99 <b>GM-4</b>
<b>F</b>	3/4"	1 1/8"	60	7.99 <b>GM-5</b>
<b>G</b>	1/4"	1 1/8"	60	7.99 <b>GM-15</b>
<b>H</b>	3/8"	1"	60	7.99 <b>GM-23</b>
<b>I</b>	1"	1"	60	7.99 <b>GM-25</b>
<b>J</b>	5/8"	3/8"	60	7.99 <b>GM-26</b>
<b>K</b>	1 1/8"	1"	60	7.99 <b>GM-31</b>
<b>L</b>	1"	1"	60	7.99 <b>GM-38</b>
<b>M</b>	3/4"	3/8"	40	7.99 <b>GM-40</b>
<b>N</b>	1 1/2"	1 1/8"	60	7.99 <b>GM-236</b>



## 1/4" Carbide Rotary Files

- Cryogenically treated • Nose design reduces back-gouging
- 1/4" shank • Shanks 4" long except MRT-56C at 6" long

Dia.	Lgth	Jobber	Order No.
<b>A</b>	.375" 1.000"	\$44.99	<b>MSH-34C</b>
<b>B</b>	.437" .970"	57.99	<b>MRT-44C</b>
<b>C</b>	.437" .875"	44.99	<b>MSE-44C</b>
<b>D</b>	.500" .975"	57.99	<b>MRT-54C</b>

Dia.	Lgth	Jobber	Order No.
<b>E</b>	.500" 1.000"	\$57.99	<b>MRT-56C</b>
<b>F</b>	.500" .880"	44.99	<b>MSE-54C</b>
<b>G</b>	.500" 1.000"	44.99	<b>MSF-54C</b>
<b>H</b>	.500" 1.245"	49.99	<b>MSH-54C</b>



**Parts Trays ... the more you buy, the more you save!**

Order 4-9 save 10% off jobber, 10 or more save 20% off jobber  
Mix or Match to make quantities



## Dual Overhead Cam Cylinder Head Organizer Tray

- Store valves, springs, retainers, keepers, valve lash adjusters & camshafts
- Virtually unbreakable
- Oil and solvent resistant
- Keep valve lash adjusters from getting mixed up and changing the valve adjustment
- 23¼" x 26½" x 2"
- Order No. **DOHC-1** Jobber \$47.29



*Dimensional weight & surcharges may apply*



## Stackable Cylinder Head Organizer Trays

- Store valves, springs, retainers and keepers in order of assembly • Impervious to oil and most solvents
- Measures 28" x 12½" x 3"H
- Order No. **SHO-8** Jobber \$54.99

*Dimensional weight & surcharges may apply*

## Valve Train Tray For 4, 6 or 8-Cylinder OHV Engines

- Heavy duty construction
- Keeps push rods, rockers, lifters, etc. in order
- Unbreakable
- 64 compartments
- Measures 11½"W x 13½"D x 1½" H
- Order No. **VTO-80** Jobber \$46.99



*Dimensional weight & surcharges may apply*



## Bifocal Magnifying Safety Glasses

Diopter	Jobber	Order No.	Diopter	Jobber	Order No.
1.00	\$16.99	<b>BSG-100</b>	2.00	\$16.99	<b>BSG-200</b>
1.25	16.99	<b>BSG-125</b>	2.25	16.99	<b>BSG-225</b>
1.50	16.99	<b>BSG-150</b>	2.50	16.99	<b>BSG-250</b>
1.75	16.99	<b>BSG-175</b>	3.00	16.99	<b>BSG-300</b>

Top tray features 1" deep lip to keep parts from rolling off

Solid steel hangers hold piston rods and crankshafts

Heavy duty casters make moving the engine and cart easy

## Engine Storage Cart

- An efficient space-saver
- Heavy-duty casters
- Holds all engine parts off the floor from tear-down to reassembly in less than 4 square feet
- Move the whole engine easily
- Some assembly required
- Order No. **EC-200** Jobber \$369.99

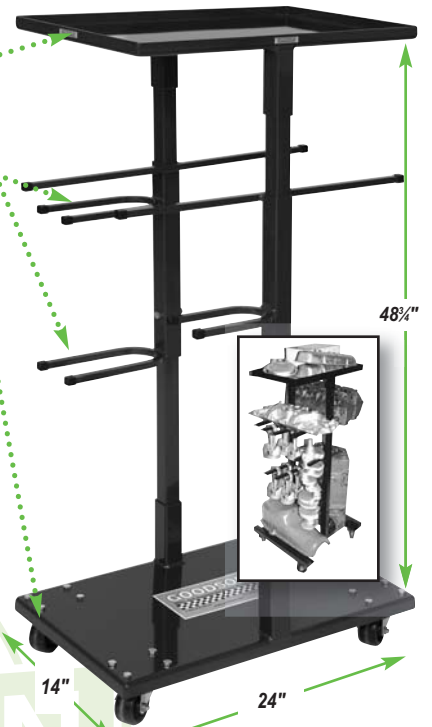

CYLINDER HEAD REBUILDING

CLEANING, ASSEMBLY & SAFETY

SHORT BLOCK REBUILDING

CRANKSHAFT/ FLYWHEEL GRINDING

MISCELLANEOUS TOOLS & SUPPLIES

BRAKE & TIRE CHANGING TOOLS

MEASURING TOOLS

V-TWIN & METRIC HARD PARTS

## Ford/Chevy Block Organizer Tray

- Store pistons, rods, lifters, push rods & camshafts
- Formed compartments keep engine components securely in place



Fits	Size	Jobber	Order No.
Small Block	24¼"x25½"x1½"D	\$31.79	<b>IEO-80</b>
Big Block	30¼"x28½"x1¼"D	39.99	<b>IEO-90</b>

*Dimensional weight & surcharges may apply*



Quantity discount does not apply

## Harley® Head Organizer Tray

- Virtually unbreakable molded plastic • Oil and solvent resistant • Trays stack for easy storage
- Measures 27½" x 14¼" x 3"
- Order No. **HHO-2** Jobber \$29.99

*Dimensional weight & surcharges may apply*



CYLINDER HEAD REBUILDING  
CLEANING, ASSEMBLY & SAFETY  
SHORT BLOCK REBUILDING  
CRANKSHAFT/ FLYWHEEL GRINDING  
MISCELLANEOUS TOOLS & SUPPLIES  
BRAKE & TIRE CHANGING TOOLS  
MEASURING TOOLS  
V-TWIN & METRIC HARD PARTS



### End Brushes 1/4" shank

Dia. / Wire gauge / Type	Jobber	Order No.
<b>Standard Duty</b>		
1/2" .020" crimped	\$ 7.99	<b>GBC-4</b>
3/4" .020" crimped	9.79	<b>GBC-6</b>
1" .020" crimped	11.79	<b>GBC-10</b>
1 1/2" .020" crimped	9.99	<b>GBC-14</b>
1 3/4" .012" crimped	11.79	<b>NH-16</b>
2 3/4" .012" crimped	14.99	<b>NH-26</b>
1 3/4" .014" galv. for alum.	9.99	<b>ANH-16</b>
2 3/4" .014" galv. for alum.	9.99	<b>ANH-26</b>
<b>Ultra Duty (listed left to right)</b>		
1/2" .014" crimped	\$ 7.99	<b>GBC-4A</b>
1 1/8" .020" knotted	13.99	<b>GBC-12</b>
1 1/8" .020" knotted	14.99	<b>GBC-12HD</b>
3/4" .020" knotted	10.99	<b>NH-6</b>

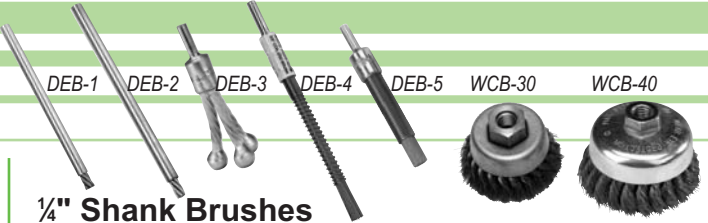

### 1/4" Shank Brushes

Deep Well End Brush as brush wears cut back to expose new wire			
Dia.	Wire Gauge	Grade	Jobber Order No.
1/4"	.012", 6" long	Economy	\$11.79 <b>DEB-1</b>
3/8"	.017", 6" long	Economy	15.79 <b>DEB-2</b>
Flare Brush use to remove carbon from engine ports			
1/2" ball, 3/16" cable		Ultra-duty	\$47.29 <b>DEB-3</b>
Port Brush as brush wears cut back spring for new wire			
1/4"	.014", 4" long	Standard	\$20.99 <b>DEB-4</b>
1/2"	.020", 2 1/2" long	Ultra-duty	20.99 <b>DEB-5</b>
Cup Brush 5/8"-11 NC - fits standard 4 1/2" angle grinder			
3"	.014" twisted	Ultra-duty	\$24.99 <b>WCB-30</b>
4"	.014" twisted	Ultra-duty	32.79 <b>WCB-40</b>

### Engine Prep Brushes

Application	Jobber	Order No.
For small feed hole in block 1/4" x 2" x 10", nylon	\$5.49	<b>OB-1</b>
For cams 5/16" x 2 1/2" x 12", nylon	5.49	<b>OB-2</b>
Like OB-2 but more flexible 5/16" x 2 1/2" x 12", nylon	5.49	<b>OB-2A</b>
For oil return lines 3/8" x 2 1/2" x 12", nylon	5.49	<b>OB-3</b>
For diesel injector 1 3/4" brush, stainless	7.99	<b>DIB-1</b>
For lifter bores 1" x 3" x 14", nylon	8.49	<b>LBB-100</b>

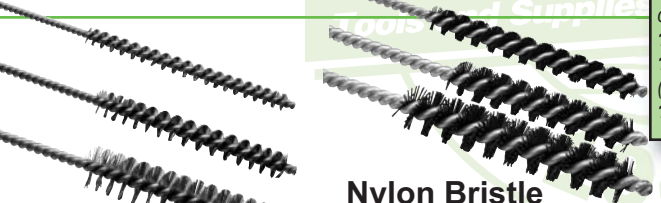

### Nylon Bristle Oil Gallery Brushes

Desc.	Jobber	Order No.	Incl.
<b>5-pc. Kit \$27.99 OGB-KIT</b>			
3/8" x 3" x 34"	6.49	<b>OGB-38</b>	x
1/2" x 2 1/2" x 34"	6.79	<b>OGB-42</b>	x
5/8" x 3" x 34"	6.79	<b>OGB-5</b>	x
3/4" x 3" x 34"	7.49	<b>OGB-7</b>	x
3/4" x 3" x 40"	8.99	<b>OGB-8</b>	x

### Steel Wire Oil Gallery Brushes

Desc.	Jobber	Order No.	Incl.
<b>3-pc. Kit \$16.99 OGB-SK</b>			
1/4" x 3" x 24"	7.49	<b>OGB-1</b>	x
3/8" x 3" x 24"	8.49	<b>OGB-2</b>	x
5/8" x 3" x 24"	9.49	<b>OGB-3</b>	x

**PRICE CUT**

### Scratch Brush

- 4 x 19 row
- 13 3/4" long
- Wood handle
- Steel bristles
- Order No. **HB-49**

Jobber \$2.99

### Manual Guide Cleaning Brush

- OAL: 8 3/4"
- Order No. **WCB-44**

Jobber \$3.29

### Round Fiber Parts Brush

- 11" long
- Nylon bristles
- Plastic Handle
- Order No. **PCB-348**

Jobber \$7.99

Order 5 or more brushes, (any combination) take 10% off jobber, 15 or more brushes, (any combination) 15% off jobber

### Bore Washing Brushes

Dia.	Length	Jobber	Order No.
2"	36"	\$18.99	<b>CBB-200</b>
2 1/4"	36"	19.99	<b>CBB-225</b>
2 1/2"	36"	20.99	<b>CBB-250</b>
2 3/4"	18 1/2"	23.29	<b>CWB-27W</b>
3 1/2"	18 1/2"	23.29	<b>CWB-35</b>
4"	18 1/2"	23.29	<b>CWB-40</b>
4 1/2"	18 1/2"	24.29	<b>CWB-45</b>
5"	18 1/2"	25.29	<b>CWB-50</b>

### Flow Through Parts Washing Brush

- 24" long hose slides over discharge nozzle on parts washer
- Order No. **PWB-FLO-1**

Jobber \$24.99



### Pushrod Brush

- Clean the inside diameter of your pushrods with this brush
- Will fit pushrods as small as .080" ID
- 12" overall length
- Order No. **PRB-80**

Jobber \$12.99

### tech tips

from the techxperts™

It's important to clean the insides of your pushrods when rebuilding an engine. Not cleaning the ID of the pushrods is like putting your dirty clothes on after a bath; you risk contaminating all of the work you've done. You need the pushrod brush because the ID is so small it's unlikely that your hot tank will be able to get the gunk out.

### Valve Guide Brushes

Size	Steel Brushes		Nylon Brushes	
	OAL	Order No.	OAL	Order No.
5/16" x 2 1/2"	9 1/2"	<b>GVP-1</b>	12"	<b>GVP-1N</b>
1 1/32" x 2 1/2"	9 1/2"	<b>GVP-2</b>	12"	<b>GVP-2N</b>
3/8" x 2 1/2"	9 1/2"	<b>GVP-3</b>	12"	<b>GVP-3N</b>
7/16" x 2 1/2"	9 1/2"	<b>GVP-4</b>	12"	<b>GVP-4N</b>
1/2" x 2 1/2"	—	—	10 1/2"	<b>GVP-5N</b>
9/16" x 2 1/2"	—	—	10 1/2"	<b>GVP-6N</b>
3mm x 1 1/4"	8"	<b>GVP-7S</b>	8"	<b>GVP-7N</b>
4mm x 1 1/4"	8"	<b>GVP-8S</b>	8"	<b>GVP-8N</b>
5mm x 1 1/4"	8"	<b>GVP-9S</b>	8"	<b>GVP-9N</b>
6mm x 1 1/4"	8"	<b>GVP-10S</b>	8"	<b>GVP-10N</b>
7mm x 1 1/4"	8"	<b>GVP-11S</b>	8"	<b>GVP-11N</b>
Jobber		\$6.79 ea.		\$6.79 ea.





## Radial Wire Brushes

### Crimped ... Standard & Heavy-Duty

This shape is specially designed to flex, giving longer life. The crimp also lets wires nestle together to support one another for more aggressive cleaning.

### Twisted ... Super Duty

Tougher than crimped, strands are twisted  $\frac{3}{4}$  of the length for stiffness with flexible ends that stay tight in use. These brushes are designed to be used at higher RPMs.

### Knotted ... Ultra Duty

Strands are twisted full length for best stiffness and fastest cleaning. Knots have more strands to resist breakage and outlast typical knotted brushes by a wide margin.

Order 5 or more brushes, (any combination) take 10% off jobber, 15 or more brushes, (any combination) 15% off jobber



#### Radial Wire Brushes

- American made oil tempered high carbon steel wire
- High density for faster cleaning and longer life
- Excellent balance •  $\frac{1}{2}$ "- $\frac{5}{8}$ " arbor

Size	Wire	Duty	Jobber	Order No.
6"x $\frac{1}{4}$ "	.014" Crimped	Std.	\$14.99	ADA-6
7"x $\frac{7}{8}$ "	.014" Crimped	Heavy	41.99	DA-7
6"x $\frac{9}{16}$ "	.016" Twisted	Super	21.99	TS-6
8"x $\frac{3}{4}$ "	.016" Twisted	Super	49.99	TS-8
6"x $\frac{7}{16}$ "	.023" Knotted	Ultra	23.99	QTC-6

An \$84 value when purchased separately



BG-KIT

### Engine Rebuild Brush Kit

- Includes the brushes you'll need for an average engine job
- A great starting place, then add more brushes as you need them
- Replacement brushes available

Description	Jobber	Order No.
Standard Brush Kit - 10 Pc. Kit	\$54.99	BG-KIT
4" Nylon Cylinder Washing Brush	23.29	CWB-40
$\frac{1}{2}$ " Nylon Valve Guide Brush	6.79	GVP-2N
$\frac{3}{8}$ " Nylon Valve Guide Brush	6.79	GVP-3N
Lifter Bore Brush	8.49	LBB-100
Small Nylon Feed Hole Brush	5.49	OB-1
Block Oil Return Line Brush	5.49	OB-2
$\frac{3}{8}$ " Oil Gallery Brush	6.49	OGB-38
$\frac{1}{2}$ " Oil Gallery Brush	6.79	OGB-42
$\frac{5}{8}$ " Oil Gallery Brush	6.79	OGB-5
Round Fiber Parts Brush	7.99	PCB-348

### Roloc Bristle Discs

- Effective on cast iron, yet safe for aluminum
- Abrasive grains embedded in plastic bristles that break down exposing new grain

#### Roloc Bristle Discs

Size	Color	Grit	Max. RPM	Jobber	Order No.
2"	Green	50	25,000	\$11.79	RBD-2G
	Yellow	80	25,000	11.79	RBD-2Y
	White	120	25,000	11.79	RBD-2W
3"	Green	50	18,000	18.79	RBD-3G
	Yellow	80	18,000	18.79	RBD-3Y

#### Holders

Size	Description	Jobber	Order No.
2"	Roloc-Type Holder	\$14.99	RLH-2
3"	Roloc-Type Holder	16.99	RLH-3



Now available in  $\frac{5}{8}$ " Wide Model

### Super Scraper™

- Remove gaskets, carbon, rust, paint, etc.
- Precision-ground • Solid carbide-tipped • Double-edged blade
- Lasts longer than plain steel • Nickel-chrome •  $\frac{1}{8}$ " thick steel shank • For all metals including aluminum

Width	Jobber	Order No.
$\frac{3}{8}$ "	\$24.99	SS-4U625
$1\frac{1}{4}$ "	29.99	SS-4U
2"	41.99	SS-4U2

Buy one of each size and save 10% off jobber!



### Pneumatic Scraper

- Faster and easier than scraping by hand
- Beveled, 1" steel blade • Removes gaskets with 2500,  $\frac{3}{64}$ " strokes per minute • Resharpenable blade

Description	Jobber	Order No.
Complete Tool	\$99.99	AGS-310
Replacement Blade	15.79	AGS-310B

See Pages 128-129 for Keepers

See Page 127 & 132 for Valve Stems



### Keeper-Keeper

- Screws closed tightly
- $\frac{1}{4}$ " holes
- Ideal for tumbling keepers
- Solvent resistant PVC
- Order No. **VK-15**
- Jobber \$15.99

### Valve Stem Protectors

- Protects against parts tumbler damage
- Slips on and off easily
- 16 per package
- Order No. **VSP-16**
- Jobber \$12.99



**Full Service  
FAST!!**



"We believe that every customer is important. If you need one of our tools or supplies overnight or have a last minute change on your order you can count on Goodson. You'll always receive the kind of courteous, personal attention that shows how much we appreciate you doing business with us."  
- Jarrad, Goodson Shipping Department, 1 year of service

CYLINDER HEAD  
REBUILDING

CLEANING,  
ASSEMBLY & SAFETY

SHORT BLOCK  
REBUILDING

CRANKSHAFT/  
FLYWHEEL GRINDING

MISCELLANEOUS  
TOOLS & SUPPLIES

BRAKE & TIRE  
CHANGING TOOLS

MEASURING  
TOOLS

V-TWIN & METRIC  
HARD PARTS

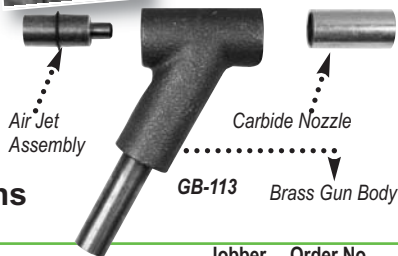

### Glass Bead Guns

- Solid brass body

Description	Jobber	Order No.
<b>Complete Gun For Smaller Machines</b>	\$104.99	<b>GB-113</b>
Fits Trinco, Econoline, etc. Includes Gun Body, Nozzle and Air Jet Assembly		
Replacement Parts	Jobber	Order No.
Gun body only	\$59.99	<b>GB-111</b>
Carbide nozzle 19.05mm OD, 7.94mm ID	48.99	<b>GB-204</b>
Air jet assembly 3.97mm ID, 25 CFM	19.99	<b>GB-330</b>

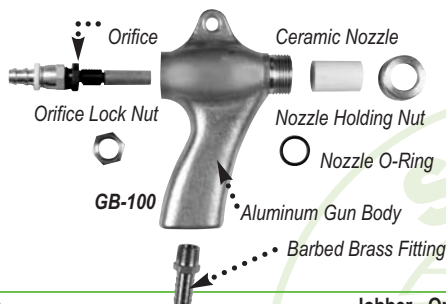

Description	Jobber	Order No.		
<b>Complete Gun For Larger Machines</b>	\$139.99	<b>GB-100</b>		
Fits Zero, Blast-It-All, Winona Van Norman, etc. Includes ceramic nozzle (GB-75) .313" / 7.94mm ID standard				
Replacement Parts	Jobber	Order No.		
Gun body only	\$83.49	<b>GB-101</b>		
Barbed Brass fitting	8.49	<b>GB-04</b>		
Nozzle holding nut (not included in kit)	14.99	<b>GB-54</b>		
Rebuild Kits	Jobber	Order No.	Includes	
.250" ID	\$59.99	<b>GB-4-OK</b>		
.313" ID	59.99	<b>GB-5-OK</b>		
.375" ID	59.99	<b>GB-6-OK</b>		
.437" ID	59.99	<b>GB-7-OK</b>		
Ceramic Nozzles				
.250" ID	22.99	<b>GB-74</b>	x	
7/8" OD x 1 3/8"	.313" ID	22.99	<b>GB-75</b>	x
	.375" ID	22.99	<b>GB-76</b>	x
	.437" ID	22.99	<b>GB-77</b>	x
Replacement Orifices				
	44.99	<b>GB-64</b>	x	
	44.99	<b>GB-65</b>	x	
	44.99	<b>GB-66</b>	x	
	44.99	<b>GB-67</b>	x	
Lock Nut	8.79	<b>GB-52</b>	x x x x	
O-Ring	6.49	<b>GB-53</b>	x x x x	

### Trigger-Control Glass Bead Gun

- Uses 9 CFM of compressed air
- Replacement gun
- Gun includes replaceable ceramic nozzle
- Nozzle diameter: 3/16" (4.76mm)
- For most economy bench-top glass bead cabinets
- Fits most cabinets with 1/2" (12.7mm) ID media supply line, threaded for 1/4" (6.35mm) air line fitting



Description	Jobber	Order No.
Trigger-Control Glass Bead Gun	\$99.99	<b>GB-9</b>
Replacement Nozzles (3 pack)	41.29	<b>GB-9-NOZ</b>



### Glass Bead Gloves

- 30" overall length • For ports up to 10" diameter
- Durable cloth-lined Neoprene glove with nylon sleeve
- Sleeve design makes attaching glove to your machine, faster and easier • Clamp sold separately

Port Size	Description	Jobber	Order No.
Up to 8" (20.32 cm)	<b>Single:</b> left-hand glove	\$37.99	<b>GB-654-G</b>
	<b>Single:</b> right-hand glove	37.99	<b>GB-655-G</b>
	<b>Pair:</b> one right-hand & one left-hand	62.99	<b>GB-660-G</b>
	<b>Pair+:</b> one right-hand, two left-hand	82.99	<b>GB-663-G</b>
Up to 10" (25.4 cm)	<b>Single:</b> left-hand glove	48.99	<b>GB-754-G</b>
	<b>Single:</b> right-hand glove	48.99	<b>GB-755-G</b>
	<b>Pair:</b> one right-hand & one left-hand	79.99	<b>GB-770-G</b>
	<b>8" and 10" Replacement Clamp:</b> fits both port sizes	7.89	<b>GB-CLAMP</b>

**SAFETY TIP: NEVER point the Glass Bead Gun at the cabinet window**

### Glass Beads

- Clean parts thoroughly without removing material
  - 50 lb. bag • Size #8
  - Safe for ferrous & non-ferrous materials
  - Order No. **GB-CM**
- Jobber \$49.99

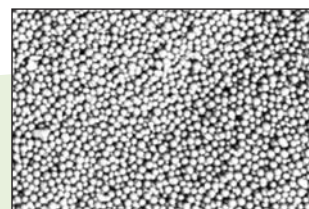

### Glass Bead Cabinet Window Film

- Protects the inside of glass bead cabinet windows
  - Save time and money – replace the film rather than the glass • 24" x 10' roll
  - Order No. **GB-FILM**
- Jobber \$18.99

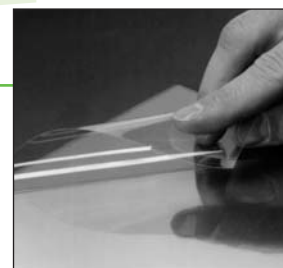

### tech tips

from the techxperts™  
For best results, attach film to cabinet window with ordinary double-faced tape (not included)

BG-150

### Hydro-Air Guns

- Hold the BG-150 by the air supply hose
- The grip stays cool even when spraying hot water • BG-100 Trigger Action gun uses water and air pressure to deliver a powerful stream of "cold steam"
- BG-100 includes siphon tube, extension nozzle & flushing adaptor and connects to openings 3/4" to 1 1/2" in diameter

Description	Jobber	Order No.
Hydro-Air Gun	\$ 94.79	<b>BG-150</b>
Trigger-Action Hydro-Air Gun	139.99	<b>BG-100</b>
Replacement Nozzle for BG-100	27.99	<b>BG-NOZZLE</b>

## Cleaning Media

### For Part Tumblers

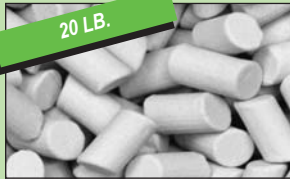

**Ceramic Diagonals (20 lb.)**  
For soft materials such as brass and aluminum.  $\frac{5}{16}$ " dia.,  $\frac{5}{8}$ " long  
Order No. **PTM-20CR** \$69.99



**Steel Ballcones (20 lb.)**  
Ideal for Springs.  
.385" ball in .475" cone  
Order No. **PTM-20BC** \$149.99



**Steel Diagonals (20 lb.)**  
Ideal for valves.  
 $\frac{3}{8}$ " dia.,  $\frac{5}{8}$ " long  
Order No. **PTM-20D** \$149.99

### For Airless Blasters

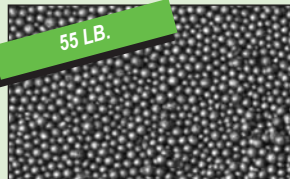

**Steel Shot, 170 grade (55 lb.)**  
Ideal for cleaning cast iron heads.  
Diameter varies from .017" to .024".  
Order No. **SS-CM** \$49.99

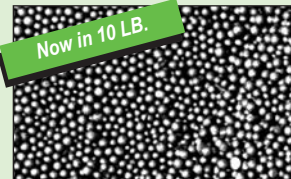

**Stainless Steel Shot, Conditioned.**  
Clean aluminum heads to look like new.  
Restores bright aluminum finish. Lasts longer than plain carbon steel shot.  
Diameter varies from .006" to .016".  
10 lb. Order No. **SS-CS10** \$69.99

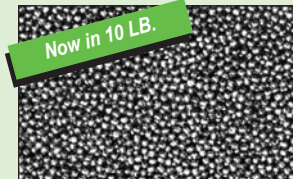

**Stainless Steel Cut Wire Shot**  
Unconditioned. Clean cast iron or aluminum heads before and normalize after welding. Helps prevent surface corrosion after blasting. .020" Diameter.  
10 lb. Order No. **SS-CW10** \$109.99



**The more you buy, the more you save!**

Order 6 or more pairs of HTG gloves (any combination) & save 10% off jobber!

### Hot Tank Gloves

- Not for solvent use
- Sold in pairs
- Shoulder length features eyelets & strings at tops to prevent slipping

Description	Jobber	Order No.
Gauntlet Length (12" long)	\$23.99	<b>HTG-200</b>
Elbow Length (18 $\frac{1}{2}$ " long)	33.99	<b>HTG-200E</b>
Shoulder Length (34 $\frac{1}{2}$ " long)	47.99	<b>HTG-200L</b>



### Full Length Neoprene Shop Apron

- Protects from caustics, steam, grease and oil
- Bib-style • 35" x 45"
- Order No. **HTA-300**  
Jobber \$29.99

Shown with Shoulder Length Hot Tank Gloves (above)



### Cloth Shop Apron

- Bib-style apron
- Heavy duty black fabric
- Several handy pockets
- Embroidered Goodson Racing logo
- Machine Washable
- Order No. **CA-100**  
Jobber \$26.29



### Mirrored Safety Glasses

- Wrap-around design provides protection against moderate impact hazards such as metal chips, sparks and particles
- Tinted lenses provide sun glare protection
- Universal bridge • Polycarbonate lenses
- Do not use as welders helpers
- Order No. **PGL-21** Jobber \$4.99



### Parts Tumbler Solution

- Dilute 30:1 with water
- For best results, dry parts with compressed air • 1 gallon
- Order No. **PT-SOL**  
Jobber \$13.99



### Parts Tumbler Rebuild Kit For Sioux™ 710 Parts Tumbler

- Replaces discontinued Sioux™ parts

Description	Jobber	Order No.
Rebuild Kit	\$249.99	<b>SX-710-KIT</b>
Steel Gear	57.79	<b>271</b>
Fiber Gear	57.79	<b>19275</b>



### Parts Tumbler Basket

- Fits Goodson, K.I., Axe, RMC, and Peterson
- 8" x 12" x 12"
- Order No. **PT-BASKET**  
Jobber \$274.99

CYLINDER HEAD REBUILDING  
CLEANING, ASSEMBLY & SAFETY  
SHORT BLOCK REBUILDING  
FLYWHEEL GRINDING  
CRANKSHAFT/ MISCELLANEOUS  
TOOLS & SUPPLIES  
BRAKE & TIRE CHANGING TOOLS  
MEASURING TOOLS  
V-TWIN & METRIC HARD PARTS

CYLINDER HEAD REBUILDING  
CLEANING, ASSEMBLY & SAFETY  
SHORT BLOCK REBUILDING  
CRANKSHAFT/ FLYWHEEL GRINDING  
MISCELLANEOUS TOOLS & SUPPLIES  
BRAKE & TIRE CHANGING TOOLS  
MEASURING TOOLS  
V-TWIN & METRIC HARD PARTS



### Cosmoline®

- Brush directly from can onto freshly-machined engine components
- Protects iron, steel and aluminum
- Soften with mineral oil to dip small parts

Quantity	Jobber	Order No.
2 lbs.	\$ 31.99	RPC-2A
35 lbs.	379.99	RPC-35A



### Rust Proofing Oil

- Apply full strength • Creates a protective film • Washes off with standard solvents
- Brush or spray on using the Sure Shot Sprayer (below)
- 1 Gallon / 3.78 L
- Order No. **RPO-10**
- Jobber \$89.99

Order 6 or more cans (any combination), save 10% off jobber



### Rust Shield

- Short-term**
- Non-sticky
  - Lasts several weeks
  - Wipes off with just a towel
- Long-term**
- Formula is thicker and protects much longer but requires a solvent to remove
- | Formula    | Jobber  | Order No. |
|------------|---------|-----------|
| Short Term | \$12.99 | RS-16*    |
| Long Term  | 16.79   | RS-16-OD* |
- \*Hazardous Fees Apply If Shipped Air



### Rust Shield for Shop Equipment

- Stops rust without causing rancidity • Apply to machine parts such as ways
- Mixes with coolant – no need to remove before machining • 1 Gallon / 3.78 L
- Order No. **RS-128**
- Jobber \$27.99

### Silver Anodized 24 oz. Sure Shot® Sprayer

- Pressurize it with shop air – 80-150 psi
- No hoses or cords to limit movement
- Spray nozzle adjusts from stream to spray
- Can be used with most oil, solvent and water based materials
- Not for paint



Description	Jobber	Order No.
Sure Shot Sprayer	\$109.99	PS-2014
Replacement Nozzle Washer	1.49	PS-2014NW
Replacement Tank-Body O-Ring	10.79	PS-2014OR

ACH-400



ACH-600



### Adjustable Coolant Hoses

- Universal hoses hold any shape
- Ideal for all crankgrinders, honing machines, flywheel grinders and surface grinding machines
- Snap together hose lets you make any length
- Chemical resistant

Description	Jobber	Order No.
1/4" Hose Kit	\$16.99	ACH-400
Includes 18" long hose, 1/4" & 1/8" NPT fittings, 1/8", 3/8" & 1/2" round nozzles		
Fits most parts washers, wet-type seat grinders, and valve refacers		
1/2" Hose Kit	17.99	ACH-600
Includes 16 1/2" long hose, 1/2" & 1/4" NPT fittings, 1/4", 3/8" & 1/2" round nozzles		
Fits most cylinder hones and flywheel grinders		
1" flare nozzle for 1/4" hoses	\$ 7.99	ACH-407
1 1/4" flare nozzle for 1/2" hoses	8.99	ACH-807
2 1/2" flare nozzle for 1/2" hoses	9.99	ACH-809
1/4" ID hose, 11" long	11.99	ACH-401
1/2" ID hose, 11" long	11.99	ACH-801
1/2" NPT connector for 1/4" ID	6.99	ACH-406
3/8" NPT connector for 1/2" ID	6.99	ACH-804
1/2" NPT connector for 1/2" ID	6.99	ACH-805

### Sludge Filter Bag

- Fits any machine with a coolant sump
- Replace costly OE filters with this economical, universal sock
- Adds filtration to machines that don't have enough • 8" x 24" polyester knit sock
- Order No. **SB-1** Jobber \$8.99



## Coolant Pumps

### 170 Gal. Per Hour Pump

- HP: 1/125
- Capacity: 170 gal/hr. at 1" depth • Hi-temp Seals
- Voltage: 115
- Size: 4" x 3 3/4" x 2 3/4"
- Order No. **COP-166**
- Jobber \$112.99



### 1200 Gal. Per Hour Pump

- HP: 1/6
- Capacity: 1200 gal/hr. at 1" depth
- Voltage: 115
- Size: 7 3/4" x 6 1/8" x 4 5/16"
- Order No. **COP-1833**
- Jobber \$154.99



### Universal Coolant Magnet

- Ideal for Honing Tanks, Flywheel Grinders, Crankshaft Grinders, and more
- Prevents metal swarf from passing into the coolant tank
- Cut or shape to fit machine bases and return ways
- Measures 3"x48"
- Order No. **UCM-348**
- Jobber \$23.29



**new**



## Defoaming Agent Stops Foaming In Solvents And Coolants

- For jet washers, air-agitated hot tanks and coolant sumps
- Highly concentrated – start with 1 ounce in 50 gallons

Size	Jobber	Order No.
8 oz. / 236.6mL	\$11.79	D-FOAM-10
1 gallon / 3.79 L	34.79	D-FOAM-128

## Multi-Purpose Parts Degreasing Detergent

- Highly versatile detergent cleans a variety of things in and around your shop - floors, machines, parts, countertops, benchtops and more
- **Not for use in Jet Wash**

Size	Jobber	Order No.
1 Gallon	\$24.99	PD-10
5 Gallons	99.99	PD-50



## Pro Jet Spray Cleaning Powder

- Heavy-duty • Non-caustic
- Penetrates to emulsify encrusted dirt, grease and oil on cast iron & aluminum
- Won't foam excessively
- Additives prevent scale build-up in jet spray components
- Use to maximum 165° F/ 73.9° C
- Mix ratio: 4 oz. per gallon of water
- 50 lb. / 22.68 kg pail
- Order No. **PJS-50** Jobber \$109.99



## Micro Biostat

- Controls bacteria and fungus in coolant reservoirs
- Treat at 1 oz. per 5 gallons of capacity
- Operate machine for 30 minutes then empty the reservoir
- Refill with coolant and treat 1 oz. per 10 gallons
- Re-treat every 10 days to 2 weeks as needed so it can't happen again
- 20 oz. bottle
- Order No. **GBP-20** Jobber \$32.99

## Concentrated Hot Tank Detergent Powders

### For Ferrous Parts

- Strong alkaline • Removes dirt, heavy oil & grease, carbon, light rust & paint
- 25 lbs. • Mix ½ lb. to 1 gal.
- Order No. **D-CI25** Jobber \$104.99

### For Non-Ferrous Parts

- Safe on aluminum & sensitive metals, rubber & plastic parts • Removes heavy grease & oil • 50 lb. pail • Mix ratio: ¼ lb. to 1 gal. • Order No. **D-AL50** Jobber \$136.49



## Ultrasonic Detergents

- Safe to use with ferrous metals and aluminum
- Medium Duty can also be used on plastics
- For ultrasonic immersion tanks
- Medium Duty includes rust preventive
- Exceptional ultrasonic cleaning
- 5 gallon pail



Description	Mix Ratio	Jobber	Order No.
Medium Duty	1:20	\$127.99	USD-MD50
Heavy Duty	1:10	109.99	USD-HD50

### Replacement Cartridge Filters for Ultrasonic Cleaners (2" x 9"L)

Filtration	Jobber	Order No.
30 microns	\$13.99	USF-30
50 microns	13.99	USF-50



## pH Test Strips

- Easy to use • 100 tests per package
- Use the handy guide on the box to determine pH between 0 and 14
- Order No. **HT-PH** Jobber \$39.99

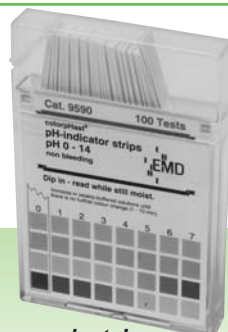

## tech tips

from the techxperts™

### Pay attention to the mix ratio on cleaning products!

It's important that you start mixing on the weak side and work your way up. An overly strong concentration is just as ineffective as an overly weak mixture. Use pH Test Strips to check the concentration.

# Full Service FAST!



"I make sure that all Goodson products are packaged properly and include instructions or important information that is useful to our customers."  
 - Jill, Goodson Receiving Department - 12 years of service

CYLINDER HEAD  
REBUILDING

## Organize, Clean And Store Small Parts With GOODSON

### Small Parts Baskets

- Galvanized, welded 1/4" mesh
- Withstands most solvents
- Not for use in caustics



### Small Basket with Lid

- 2 1/4" dia. x 7" L
- Order No. **PWB-2** Jobber \$10.99



### Medium Basket with Lid

- 4 1/2" dia. x 7" L
- Order No. **PWB-4** Jobber \$12.99

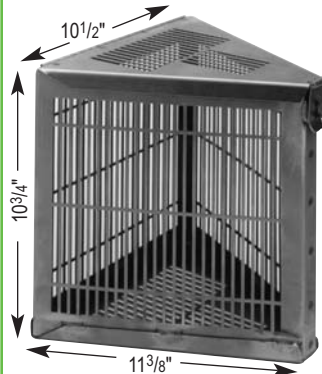

## Jet Wash Parts Basket Makes a 24" Circle

- Triangle-shaped • Sit side by side on Jet Wash table • Fit more baskets in the machine to clean faster
- Order No. **JWB-6** Jobber \$104.99

Buy a set of six and save 10% off jobber

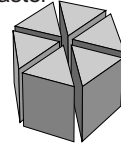

Six baskets fit in 24" diameter

CLEANING,  
ASSEMBLY & SAFETY



### Single Basket with Handle

- 8" dia. x 9" L
- Lid & clip sold separately
- Order No. **PWB-10** Jobber \$13.79



### Single Basket with Lid, Clip & Handle

- 8" dia. x 9" L
- Order No. **PWB-15** Jobber \$22.99



### Double Basket with Clip

- 9" dia. • 16" L
- Hinged on one side
- Order No. **PWB-25** Jobber \$23.99



### Lid & Clip

- For PWB-10
- Order No. **PWB-10L** Jobber \$8.99

### Clip Only

- Order No. **PWB-15C** Jobber \$2.99

SHORT BLOCK  
REBUILDING

CRANKSHAFT/  
FLYWHEEL GRINDING

MISCELLANEOUS  
TOOLS & SUPPLIES

BRAKE & TIRE  
CHANGING TOOLS

MEASURING  
TOOLS

V-TWIN & METRIC  
HARD PARTS



## Gauntlet Style Heat & Flame Resistant Gloves

- Heavy, lined red terrycloth
- 13 1/2" Long
- Safe to 450°F / 232.2°C
- Order No. **HRF-300** Jobber \$29.99



## Mirrored Safety Glasses

- Tinted lenses provide sun glare protection
- Universal bridge
- Polycarbonate lenses
- Do not use as welders helpers
- Order No. **PGL-21** Jobber \$4.99

## Nitrile Parts Washing Gloves



### Lined

- Nitrile exterior • Flock lined
- Won't swell • 13" long
- Safe for solvents

Size	Jobber	Order No.
Large	\$7.99	<b>PWG-SOL-L</b>
X-Large	9.99	<b>PWG-SOL-XL</b>



### Unlined Gloves

- Industrial quality textured Nitrile • 12" Long
- Fit either hand

Size	Qty.	Jobber	Order No.
Large	50	\$15.99	<b>PNGL-L</b>
X-Large	50	15.99	<b>PNGL-XL</b>

Buy 2 or more boxes and save 10% off jobber



## Machine Washable Cotton Shop Towels

- 15"/381mm square
- Highly absorbent
- Hundreds of uses
- Color may vary



Quantity	Jobber	Order No.
5 Pack	\$ 3.99	<b>WST-5</b>
50 Pack	16.99	<b>WST-50</b>

## Disposable Assembly Wipes

- Snow-white
- Shows dirt easily
- Pop-up box • 9" x 17"
- Ideal for a multitude of uses at the shop, at the track, even at home!



Quantity	Jobber	Order No.
100	\$19.99	<b>AW-100</b>
220	<b>YOUR BEST VALUE!</b>	24.29 <b>AW-250</b>

# Parts Organization & Storage

## Parts Tags & Marker

- Won't tear or wash off
- Tough enough to go through a jet wash or hot tank
- Heavy wire ties
- Includes 2 permanent markers
- Tag dimensions: 3½"L x 5/8"W with 5/32" hole for wire tie



Description	Jobber	Order No.
1000 Parts tags, with 2 markers	\$53.99	IDT-1000
Permanent Marker only	1.99	IDT-MARKER

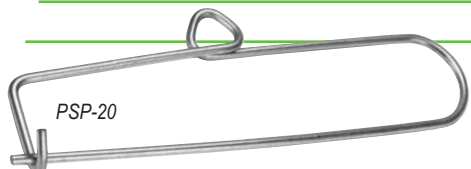

## Organizer Safety Pins Keep Part Sets Together

**Parts Safety Pin** • Organize valve springs, rods, etc., from disassembly to cleaning to reassembly  
**Rod & Cap Mini Pin** • Keep connecting rods & rod caps together to prevent mix-ups

Buy 12 or more (any combination) and save 10% off jobber

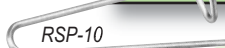

Description	Jobber	Order No.
Parts Safety Pin (3¾" x 12")	\$7.99	PSP-20
Rod & Cap Mini Pin (¾" x 4")	4.99	RSP-10

## Shrink Wrap

- Easy-to-use
- High-clarity film
- Keep machined surfaces clean
- Protects from dirt, dust and moisture
- No need to stock several bag sizes

Size	Jobber	Order No.
5" x 1000' w/ Extended Core	\$13.99	SW-5
18" x 1500' with 3" core	34.99	SW-18



## Heavy Duty Steel Stamps

- For hard materials
- Order in sets or individually
- For a single stamp, state character desired after Order No. Example: SCH-1/4(A)  
Single Character stamp, ¼" size, Letter "A"



Number Sets		Jobber	Order No.
Char. Size	Shank Size		
1/8"	5/16"	\$44.99	SFH-1/8
3/16"	3/8"	49.99	SFH-3/16
Single Characters			
3/16"	3/8"	\$8.99	SCH-3/16
1/4"	7/16"	8.99	SCH-1/4

Special and custom orders are available, call 1-800-533-8010

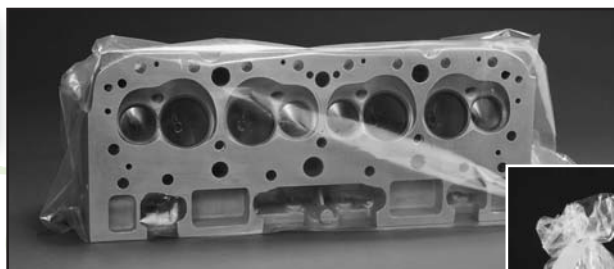

## Engine & Parts Storage Bags

- Rugged, 3-mil thickness resists tearing
- Engine bags feature 4-mil thickness for extra strength
- Protects your professional work

- Waterproof • Protect finished work from damage • 4 sizes fit most common rebuilt assemblies • Jumbo engine bags are extra-strong and big enough to accommodate complete engines • Jumbo head bags fit the largest cylinder heads
- Ideal for storing heads, cranks, blocks, etc.

Size	Description	Quantity	Jobber	Order No.
8" x 4" x 20"	Utility bag	roll of 250	\$ 49.99	BC-8
16" x 37"	Heads, cranks, misc.	box of 100	62.99	BC-15
17" x 44"	Jumbo head bag	roll of 100	69.99	BC-17
27" x 18" x 36"	Box-style for blocks	box of 50	69.99	BE-20
44" x 52"	Jumbo engine bag	roll of 50	129.99	BE-44

Order 6 or more cans (any combination), save 10% off jobber

## Short Term Rust Shield

- Non-sticky
- Lasts several weeks
- Wipes off with just a towel
- Order No. RS-16  
Jobber \$12.99



## Long Term Rust Shield

- Formula is thicker and protects much longer but requires a solvent to remove
- Order No. RS-16-OD  
Jobber \$16.79

Hazardous Goods Fees Apply When Shipped By Air

CYLINDER HEAD REBUILDING  
 CLEANING, ASSEMBLY & SAFETY  
 SHORT BLOCK REBUILDING  
 CRANKSHAFT/ FLYWHEEL GRINDING  
 MISCELLANEOUS TOOLS & SUPPLIES  
 BRAKE & TIRE CHANGING TOOLS  
 MEASURING TOOLS  
 V-TWIN & METRIC HARD PARTS

## Last Blast & Hi-Temp Last Blast



**The more you buy, the more you save**

**Order a case of 12 and save 15% off jobber**

Mix and match colors to make a case.



### Last Blast Spray Paint

- Quick-dry formula lets you handle parts in minutes
- Pigment won't smudge
- Resists abrasion, corrosion and most solvents
- Paint heads, blocks and parts just like OE
- Withstands heat up to 250°F/121.1°C
- **Last Blast** restores a "fresh from the bead-blast" look to all types of cast iron
- **Aluminum Last Blast** makes aluminum heads and parts look new
- **Color Last Blast** in popular, factory colors

Color	Jobber	Order No.
Cast Iron Gray	\$6.49	LB-1*
Aluminum Gray	6.49	ALB-1*
GM Black (Gloss)	6.99	CLB-58*
Ford/Chrys. Red	6.99	CLB-59*
Ford Blue	6.99	CLB-60*
Chevy Orange	6.99	CLB-61*

\*Hazardous Goods Fees Apply When Shipped Air

### Hi-Temp Last Blast

- Hard, chemical-resistant finish
- Withstands continuous heat up to 1200°F/648.9°C
- Won't deteriorate like ordinary paints
- For blocks, manifolds, or any external parts subjected to high heat
- Dries tack-free in 10 min., then heat at 450°F/232.2°C for 1 hour to create a professional, durable finish

Color	Jobber	Order No.
Cast Iron Gray	\$7.79	LB-1-HT*
Aluminum Gray	6.99	ALB-1-HT*
Black (Matte)	6.99	CLB-58-HT*

\*Hazardous Goods Fees Apply When Shipped Air



**Buy 5,  
(any combination)  
save 10%  
off jobber**



### Metal Markers

- No shaking needed
- Quick drying
- Withstands oil, grease and surface contact
- Won't lose its brilliance or legibility

Color	Order No.
Orange	MM-STD
Black	MM-010
Yellow	MM-030
White	MM-050
Green	MM-060
Red	MM-070
Blue	MM-080

Jobber \$5.99

### High-Performance Hylomar® Gasket Maker & Thread Sealer

- Maintains seal integrity up to 600°F / 315.5°C
- Polyol-based compound turns from a gel into flexible putty within minutes of application
- Non-hardening formula is impervious to oil, gasoline, glycol and other engine fluids
- Oxygen-sensor safe
- Seals gaps .01" or less
- 100 gram tube
- Order No. **HBS-1**  
Jobber \$19.99



### 2" Dispensing Pliers for Flexible Tubes

- Maximizes the use of all the material in the tube due to its effective means of application
- Dispenses even the thickest sealant through a very small opening, permitting better application control
- Reduces both cleanup time and the possibility of skin contact or other problems caused by excess material squeeze-out
- Order No. **EB-416** Jobber \$19.29



### Protect Your Assembled Heads and Block with Jumbo Engine Bags

- 4 mil thickness
- 44" x 52"
- 50 per roll
- Order No. **BE-44**  
Jobber \$129.99





# Assembly & Break-In

Buy 12 or more and SAVE 10% off jobber!



## Press Fit Lube

- A light coat eases press fit
- Ideal for valve guides, piston pins, cylinder sleeves, etc.
- Eliminates the scoring, gouging and galling of parts during press fitting
- 6 oz. (177.4mL) • Aerosol\*
- Order No. **PFL-200** Jobber \$11.99

\*Hazardous Goods Fees Apply When Shipped Air

CYLINDER HEAD  
REBUILDING

CLEANING,  
ASSEMBLY & SAFETY

## First Lube Engine Assembly Lube

- Prevent dry engine start-ups after long-term storage
- Clings and forms a slick wall between moving parts
- Withstands start-up pressure
- Compatible with all motor oils



Size	Jobber	Order No.
8 oz./236.6 mL	\$ 6.99	FL-10
1 gal./3.78 L	37.99	FL-128

SHORT BLOCK  
REBUILDING

CRANKSHAFT/  
FLYWHEEL GRINDING

MISCELLANEOUS  
TOOLS & SUPPLIES

BRAKE & TIRE  
CHANGING TOOLS

MEASURING  
TOOLS

V-TWIN & METRIC  
HARD PARTS



## Press Fit Lubricant

- A light coat eases assembly
- Multiple applications
- Eliminates scoring gouging and galling of parts during press fitting

Description	Jobber	Order No.
Aerosol 4.8 oz. (136g)	\$ 17.99	B-200*
Brush Applicator 200 mL	25.99	B-200L

\*Hazardous Goods Fees Apply When Shipped Air



## Cam-Shield® Camshaft Assembly Paste

- Provides anti-wear protection for camshafts during break-in
- 2500 parts per million of Zinc
- Use with mechanical and hydraulic camshafts & lifters
- For racing, street, classic, agricultural, diesel and marine camshafts

Size	Jobber	Order No.
5/8 oz. Packet	\$ 4.79	CSAP-625
4 oz. Brush Top Jar	17.99	CSAP-4



## Blood Friction Master® Engine Assembly Lube

- Contains a low friction additive for dry start-ups
- Forms a slick wall between moving parts
- Clings until dissolved by oil
- Withstands start-up pressure
- Compatible with all motor oils
- Ideal for high performance

Size	Jobber	Order No.
8 oz./236.6 mL w/brush	\$ 13.99	AL-22-8
1 gal./3.78 L w/pump	133.99	AL-22-10



## Extreme Pressure Lube

- Withstands pressures up to 50,000 PSI
- Highly refined petroleum product
- Contains no lead, graphite or minerals
- Won't corrode fine surfaces or emulsify with cooling liquids
- Surfaces stay lubed and protected
- In a grease form • 4 fl. oz.
- Order No. **EPL-4** Jobber \$7.99



## Disposable Assembly Wipes

- Snow-white
- Shows dirt easily
- Pop-up box
- 9" x 17"
- Ideal for a multitude of uses at the shop, at the track, even at home!



Quantity	Jobber	Order No.
100	\$19.99	AW-100
220	<b>YOUR BEST VALUE!</b>	24.29
		<b>AW-250</b>

## Spray Assembly Lube

- Ideal for prelubricating parts to ease assembly
- Eliminates critical initial run-in of new and rebuilt high-performance engine components
- Spray on bearings, crankshafts, pistons, rings, etc.
- Aerosol\* • Order No. **SAL-11** Jobber \$11.99

\* Hazardous Goods Fees Apply If Shipped Air

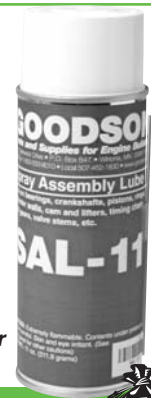

Buy 6 cans or more and SAVE 10% off jobber!





"We offer every customer the opportunity to open a Goodson account for faster, easier ordering and to save you money on C.O.D. shipments. Call today for details!"

- Diane, Goodson Customer File Maintenance - 14 years of service

Order 3 or more Flex-Hones®  
(mix & match) and save 10% off jobber



**Valve Guide Flex-Hones®**

• Kit includes the most popular sizes for valve guide work

Size	mm	OAL	Order No.	400 Grit Diamond		320 Grit Silicon-Carbide		240 Grit Silicon-Carbide	
				Jobber	Order No.	Jobber	Order No.	Jobber	Order No.
<b>6 Pc. Valve Guide Kit</b>				\$84.99	<b>VGFD-KIT</b>		▼		
5/32"	4.0	6"	VGFD-4MM					VGFD-4MM	
1/64"	4.5	6"	VGFD-4.5MM					VGFD-4.5MM	
13/64"	5.0	8"	VGFD-5MM			VGFD-5MM-320		VGFD-5MM	
7/32"	5.5	8"	VGFD-5.5MM			VGFD-5.5MM-320		VGFD-5.5MM	
1/4"	6.4	8"	VGFD-6.4MM			VGFD-6.4MM-320		VGFD-6.4MM	x
9/32"	7.0	8"	VGFD-7MM					VGFD-7MM	x
5/16"	8.0	8"	VGFD-8MM					VGFD-8MM	x
11/32"	9.0	8"	VGFD-9MM					VGFD-9MM	x
3/8"	10.0	8"	VGFD-10MM					VGFD-10MM	x
7/16"	11.0	8"	VGFD-11MM			VGFD-11MM-320		VGFD-11MM	x
15/32"	12.0	8"	VGFD-12MM					VGFD-12MM	
1/2"	12.7	8"				VGFD-12.7MM			
33/64"	13.0	8"	VGFD-13MM					VGFD-13MM	
9/16"	14.0	8"	VGFD-14MM					VGFD-14MM	
19/32"	15.0	8"	VGFD-15MM					VGFD-15MM	
				Jobber \$39.79	Jobber \$25.29	Jobber \$20.99			

**Flex-Hones® For any type and size of cylinder**

- Abrasive globules each have independent suspension
- Self-centering • Self-aligning • Self-compensating for wear
- Applications are interchangeable, select bore size
- Right Hand rotation only
- **Brake Rotor Flex-Hones®**, pg. 114 • **Plateau Soft Hones**, pg. 81
- **Honing Oil**, pg. 73

**Silicon-Carbide**

Ideal for all materials including cast iron, bronze, phosphor bronze and aluminum.

**Aluminum-Oxide**

Ideal for hard surfaces such as Nicasil and hardened steel

**Diamond**

Ideal for heat treated steel, high nickel stainless steel, chromes or plated bores, MMX aluminum alloys, ceramics and carbide

**Right Hand Rotation Only!** *tech tips*  
For best results, always use *from the Technicians* with an ample flow of honing oil.

**Ordering the right size Flex-Hone®**

Order by actual cylinder ID. All Flex-Hones® are produced oversize. If your cylinder ID is non-standard, order the next larger size. For example, for a cylinder that has been machined to 3 3/8" diameter, order a 3 1/2" cylinder hone. The "flex" that's built into the Flex-Hone® will adjust to the size difference. **NOTE:** If purchasing the 120 Grit Heavy Duty Flex-Hones®, order on cylinder size.

Size	mm	Silicon-Carbide						Aluminum Oxide								
		120 Grit Standard		120 Grit Heavy-Duty		180 Grit Standard		180 Grit - Long		320 Grit Standard		240 Grit Standard				
OAL	Jobber	Order No.	OAL	Jobber	Order No.	OAL	Jobber	Order No.	OAL	Jobber	Order No.	OAL	Jobber	Order No.		
5/8"	15.9			8"	\$17.29	BH-625										
3/4"	19.1			8"	17.99	BH-750										
13/16"	20.6			8"	21.79	BH-820										
7/8"	22.2			8"	18.29	BH-875										
1"	25.4			8"	19.29	BH-1000										
1 1/8"	28.6			8"	20.29	BH-1125										
1 1/4"	31.8			8"	21.79	BH-1250										
1 3/8"	34.9			8"	22.49	BH-1375										
1 1/2"	38.1			8"	23.99	BH-1500			8"	36.29	BG-150320					
1 5/8"	41.3			8"	23.99	BH-1625			8"	36.79	BG-162320					
1 3/4"	44.5			8"	24.99	BH-1750	17 1/2"	\$44.29	CBF-175	8"	37.49	BG-175320				
2"	50.8	8"	\$25.99	BG-210	8"	25.99	BH-2000	17 1/2"	44.79	CBF-200	8"	38.99	BG-200320			
2 1/4"	57.2	8"	27.79	BG-225	8"	28.29	BH-2250	17 1/2"	46.79	CBF-225	8"	42.49	BG-225320	8"	\$35.29	BA-225240
2 3/8"	60.2													8"	37.29	BA-237240
2 1/2"	63.5	8"	30.29	BG-250	8"	30.29	BH-2500	17 1/2"	48.79	CBF-250				8"	37.79	BA-250240
2 5/8"	66.5													8"	40.49	BA-262240
2 3/4"	69.8	8"	33.49	BG-275			8"	33.49	BH-2750	17 1/2"	60.99	CBF-275		8"	42.49	BA-275240
3"	76.2	8"	38.79	BG-300	13 1/2"	\$63.49	BGD-300			8"	58.29	BG-300320	8"	49.49	BA-300240	
3 1/4"	82.6	13 1/2"	43.79	BG-325	13 1/2"	65.49	BGD-325			13 1/2"	65.79	BG-325320	13 1/2"	55.79	BA-325240	
3 1/2"	88.9	13 1/2"	47.29	BG-350	13 1/2"	67.79	BGD-350			13 1/2"	69.89	BG-350320	13 1/2"	59.29	BA-350240	
3 3/4"	95.3	13 1/2"	50.29	BG-375	13 1/2"	72.29	BGD-375			13 1/2"	75.29	BG-375320	13 1/2"	63.79	BA-375240	
4"	101.6															
4 1/8"	104.8	13 1/2"	53.49	BG-418	13 1/2"	76.99	BGD-400									
4 1/4"	107.9															
4 3/8"	114.3	13 1/2"	67.79	BG-438						13 1/2"	80.29	BG-418320	13 1/2"	67.99	BA-418240	
4 1/2"	114.3									13 1/2"	99.99	BG-438320				
4 5/8"	117.5	13 1/2"	69.99	BG-462						13 1/2"	104.99	BG-462320	13 1/2"	75.79	BA-462240	
5"	127.0				17 1/2"	99.79	BGD-500									
5 1/2"	139.7				17 1/2"	115.49	BGD-550									
6"	152.4				17 1/2"	118.49	BGD-600									
6 1/2"	165.1				17 1/2"	127.79	BGD-650									
7"	177.8				17 1/2"	139.29	BGD-700									
7 1/2"	190.5				17 1/2"	152.99	BGD-750									
8"	203.2				17 1/2"	162.79	BGD-800									

**Heavy Duty 320 Grit Flex-Hones®**  
• Silicon-Carbide • Order on size

Size	OAL	Jobber	Order No.
4"	13 1/2"	\$118.79	BGD-400320
4 1/4"	13 1/2"	131.29	BGD-425320
4 1/2"	13 1/2"	132.49	BGD-450320

CYLINDER HEAD REBUILDING  
CLEANING, ASSEMBLY & SAFETY  
SHORT BLOCK REBUILDING  
CRANKSHAFT/ FLYWHEEL GRINDING  
MISCELLANEOUS TOOLS & SUPPLIES  
BRAKE & TIRE CHANGING TOOLS  
MEASURING TOOLS  
V-TWIN & METRIC HARD PARTS

# Index

- 3-D Fast Cut™**  
3-D Fast Cut™ Starter Kits .....4, 5  
Ball Head Drive Adaptors .....4, 5  
Bounce Springs.....4, 5  
Bowl Profiler .....10  
Counterbore Cutters .....6 - 9  
Lift Clip .....4, 10  
Micro Ball Head Tooling .....5, 7  
Pilots .....1 - 3, 5  
Setting Micrometers .....5  
Tool Setting Fixture .....4, 5  
Universal Spring Pad Cutters.....10, 40  
Valve Seat Cutter Blades .....6 - 9  
Valve Seat Cutter Tool Holder.....4, 5  
Valve Seat Removal Tooling .....5
- A**
- Abrasive Belt Dresser** .....100
- Abrasives**  
Aluminum Oxide Cloth Shop Rolls .....58  
Belts .....45, 98, 99  
Bench Grinder Wheels .....106  
Cartridge Rolls .....58  
Cam Grinding Wheels.....93  
CBN Inserts.....43  
Chamfering Cones .....40, 79  
Crankshaft Grinding .....94 - 95  
Crankshaft Polishing Belts .....98 -100  
Crocus Cloth .....58  
Cross Buffs® .....58  
Cylinder Head Resurfacing .....44 - 46  
Cylinder Honing .....72, 76-81  
Diamond Honing .....26  
Diesel Super Abrasive Insert.....43  
Discs .....58  
Flapwheels.....58  
Flex-Hones®.....28, 72, 93, 114  
Flywheel.....102 - 103  
Grinding Discs .....58  
Honing .....72, 76 - 81  
Hyper-Finish Diamond Honing.....26  
Mounted Points .....60  
PCD Inserts.....43  
Rod & Cap Grinding Wheels.....83  
Rod Honing / Pin Fitting .....82, 83  
Sleeves.....59, 113  
Valve Refacing .....22 - 23  
Valve Seat.....16 - 18
- Air Tools** .....15, 19, 29, 30, 36, 37, 63, 64
- Align Honing** .....81
- Alumni-Chek** .....50
- Ammco**  
Brake Lathe Arbor .....113  
Brake Lathe Cutting Tips .....111  
Honing Stone Sets .....79  
Replacement Parts .....110, 113 - 115
- Aprons** .....65
- Assembly Lubes** .....55, 71
- AV&V Brand Hard Parts** .....125 - 133
- B**
- Bags**  
Storage .....44, 69  
Sludge.....66
- Balance Shaft Eliminator Kits** .....51
- Balancing Scales**.....97
- Ball Head Seat Cutter Driver** .....4, 5
- Ball Hones** .....28, 72, 93, 114
- Baskets**.....65, 68
- Beehive Springs** .....129
- Beeswax** .....90
- Belt Dressers** .....100
- Belts**  
Black & Decker Valve Refacer Belt .....108  
Crankshaft Polishing .....98 -100  
Cylinder Head Resurfacing .....45  
Kwik-Way Valve Grinder Belts.....108  
Oil Pump Belts .....82, 109  
Rod Honing Belts (for Sunnen) .....82, 109  
Sioux Replacement Belts .....107  
Sunnen® Honing Machine Belts .....108
- Bench Grinder Wheels** .....106
- Bit Sharpener** .....9
- Black & Decker**  
Adaptor for Sioux Stones .....21  
Belts for Valve Refacer .....108  
Replacement Collet .....108  
Stone Holders & Accessories .....21  
Valve Refacer Wheels .....22  
Valve Seat Stones .....18
- Black Lights** .....49
- Blood Friction Master®** .....71
- Bluing Fluid** .....11, 15
- Bore Gauges and Stands**.....122, 124
- Boring Bar Cutters & Accessories** .....74 75
- Bounce Springs**.....NP-3, 4, 5, 20, 21
- Bowl Profiler Tooling & Blades** .....10
- Brake Flex-Hones®** .....114
- Brake Lathe Arbors** .....113
- Brake Lathe Cutting Tips** .....110, 115
- Brake Lathe Replacement Parts**.....113 - 117
- Brake Lathe Silencer Bands** .....112
- Brake Lathe Tip Holders**.....110, 115
- Brake Lubes** .....116
- Brass Shim Stock**.....54
- Break-In Lubes** .....71
- Bronze Liners & Tooling**.....32, 33
- Bronze Reaming Oil** .....34, 73, 130
- Bronze-Wall®, Bronze-Wall 2®** .....31
- Brushes** .....62, 63, 90, 93, 107
- Burets and Stands** .....42
- Burr Buster** .....106
- Burrs** .....60
- Bushing Press Kit** .....84
- C**
- CamShield®** .....71
- Calipers** .....120
- Camshaft Work**  
Cam Bearing Tools .....92, 93  
Cam Bore Washing Brushes.....62, 93  
Cam Wheels .....93
- Carbide**  
Brake Tips.....111, 115  
Burrs .....60  
Pilots .....2  
Reamers .....25, 130  
Resurfacing Tips .....45  
Rotary Files .....60  
Sizing Balls .....30 - 32  
Spot Facers / Top Cutters .....34
- Cartridge Rolls** .....58, 59
- CBN Cutter Inserts** .....43
- CBN Flywheel Stones** .....102
- CC-ing Equipment** .....42
- Centering Cones, 60°** .....32
- Ceramlub™** .....115
- Chamfer Tool** .....27, 33, 82
- Chamfering Cones** .....40, 79
- Chevrolet**  
Conversion Plate .....53  
Smog Plugs.....53  
Starter Drill Jig.....92
- Cleaning Supplies**  
Cleaning Media .....65  
Aprons.....65  
Baskets .....65, 68  
Brushes .....62, 63, 90, 93  
De-foaming Agent .....67  
Detergents .....67  
Glass Beads.....64  
Gloves.....65, 68  
Parts Tumbler Solution.....65  
Pro-Jet Spray Cleaning Powder.....67  
Safety Gear .....61, 65, 68  
Scrapers.....63  
Shop Towels .....66, 71  
Sludge Filter Bag .....66  
Ultrasonic Detergents & Filters .....67
- Clover Lapping Compound** .....15
- Collets**  
Black & Decker .....108  
Dowel Puller.....102  
Expanding Pilots .....2, 3
- Concentricity Gauges** .....11, 23
- Connecting Rod Heaters** .....88
- Coolants, Lubricants & Oils**  
Adjustable Coolant Hoses .....66  
All-Purpose Grinding Coolant .....73  
Belt Resurfacer Coolant .....45, 73  
Bronze Reaming Oil .....34, 73, 130  
Cosmoline® .....66  
Crank & Cam Grinding Coolant .....73, 95  
Cutting and Tapping Fluid .....11, 73  
Cylinder Honing Oil .....73, 79  
Diamond Honing Oil .....26, 73  
Extreme Pressure Lube .....71  
First Lube and Blood Friction Master® .....71  
Flywheel Grinding Coolant .....73, 103  
Flywheel Grinder Table Lubricant .....73  
Gasket Maker / Thread Sealer .....70  
High Performance Resurfacing Spray .....43, 73  
High Performance Valve Grinding Aid .....22, 73  
Hoses .....66  
Hylomar® .....70  
Knurlube .....34, 73  
Lap Oil .....9, 58, 73, 753  
Magnetic Crack Detection Oil.....50  
Micro Biostat .....67  
Minnesota Fast Freeze.....11, 14, 86  
Multi-Duty Grinding Coolant .....73  
Porting & Polishing Machining Aid .....68  
Plate Lube .....47  
Press Fit Lubricant .....30, 71, 86  
Pumps.....66  
Rod Honing Oil .....73, 82  
Rust Inhibitor for Pressure Tester.....51  
Rust Proofing Oil.....66, 73  
Rust Shield.....44, 66, 69  
Seat Cutting Fluid.....11, 73  
Spray Assembly Lube .....55, 71  
Surface Grinding Coolant .....46, 73  
Tap Oil .....51, 73  
Universal Coolant Magnet .....66

# Index

## Coolants, Lubricants & Oils (cont.)

Universal Gel Lube .....	40, 55
Valve Grinding Oil .....	22, 73
Valve Seat Machining Aid.....	11
Way Oil .....	73
Titanium Valve Grinding Aid.....	22, 73

## Core Drills / Reamers .....

.....	24
-------	----

## Cosmoline® .....

.....	66
-------	----

## Counterbore Cutter Drive Adaptors & Kit .....

.....	13
-------	----

## Counterbore Cutters .....

.....	6-10, 13, 14
-------	--------------

## Cross-Buffs® .....

.....	58
-------	----

## Crack Detection and Repair

Additives .....	50, 51
Alumni-Chek .....	50
Applicators .....	48
Black Light Crack Detection Kit.....	49
Engine Seal Tabs .....	52
Fluid Weld® .....	52
Goodson Glow .....	50
Heat Tabs .....	52
Magnetic Crack Detection Oil.....	50
Magnetic Powder .....	48
Magnetic Field Indicator .....	49
Parker Magnetic Crack Detection Unit.....	48, 49
Powder .....	48
Magnetic Crack Detection Kits .....	48, 49
Repair Kit .....	51
Seal-All™ .....	52
Small Parts Demagnetizer .....	49
Threaded Plugs .....	51
Ultra-Violet Light Inspection Kit .....	50

## Crankshaft

Balancing .....	97
Bearing Scraper .....	92
Crank Grinding Coolant .....	73, 95
Crank Grinding Wheels .....	94, 95
Crank Welding Rods .....	100
Dial Indicator, Starrett.....	97, 120
Diamond Dresser Tools.....	93, 105
Display Inspection Stand .....	57, 98, 135
Eliptibur Tool .....	101
Grinding Coolant .....	73, 95
Grinding Wheel Sizes .....	94, 95
Hardness Tester .....	93, 96
Harmonic Dampener Installer .....	101
Journal Radius Gauge .....	97
Peening Tool .....	96
Plastigage .....	96
Polishing Accessories .....	100
Polishing Belts .....	98, 99, 100
Polishers .....	100
Polisher Motor .....	100
Reluctor Ring Installation Tool .....	101
Steady Rest Shoes .....	97
Steel Stamps .....	100
Stroke Checker .....	96
Stroker Mimic™.....	96
V-Blocks .....	96

## Crocus Cloth.....

.....	58
-------	----

## Cummins Tooling .....

.....	24, 29, 30, 35
-------	----------------

## Cutter Drivers & Adaptors .....

.....	13
-------	----

## Cutting & Tapping Fluid .....

.....	11, 73
-------	--------

## Cylinder Block Work

Automotive Dowel Puller & Collets.....	102
Bore Washing Brushes .....	62, 93
Deck Bridge Combination Tool.....	123
Frost Plug Tools .....	91
Lifting Sling .....	92

## Cylinder Block Work (cont.)

Oil Gallery Brushes .....	62, 90
Oil Gallery Plugs & Tools .....	90
Pin Pal Puller .....	102

## Cylinder Head CC-ing Equipment .....

.....	42
-------	----

## Cylinder Head Resurfacing

Belt Resurfacer Coolant.....	45, 73
CBN Cutter Inserts .....	43
Dressers .....	46
Grind Aid .....	44
PCD Inserts for Aluminum .....	43
Rotary Broach Tool Bit .....	45
Segments .....	44
Surfacing Belts .....	45
Surfacing Wheels .....	46

## Cylinder Honing

Ammco .....	79
Chamfering Cones and Mandrels .....	79
Goodson .....	76 - 78
Hone Stop Collar .....	79
Honing Oil .....	73, 79
Keyway Honing Stones .....	78
Lisle® .....	76, 79
Nicasil .....	80
Portable Cylinder Honers .....	NP-7, 76
Small Diameter Honing Sets .....	76
Stones .....	76 - 81
Sunnen® .....	76 - 78, 80 - 81

## D

### D-Foam .....

.....	67
-------	----

### Dampener Installer .....

.....	101
-------	-----

### Deburring Tools .....

.....	87, 106
-------	---------

### Deck Bridge Combination Tool .....

.....	123
-------	-----

### Deck Plug Kit .....

.....	92
-------	----

### Degree Wheel.....

.....	92
-------	----

### Demagnetizer .....

.....	49
-------	----

### Depth Gauges .....

.....	102
-------	-----

### Detergents.....

.....	67
-------	----

### Dial Indicators.....

.....	97, 120
-------	---------

### Dial Bore Gauge Setting Fixtures .....

.....	122, 124
-------	----------

### Dial Bore Gauges .....

.....	122, 124
-------	----------

### Dial Caliper Gauges .....

.....	120
-------	-----

### Diamond Dresser Tools .....

.....	83, 104, 105
-------	--------------

### Diamond File Set .....

.....	9
-------	---

### Diamond Flex-Hones® .....

.....	72
-------	----

### Diamond Guide Hone Tools .....

.....	26
-------	----

### Diamond Honing Oil .....

.....	26, 73
-------	--------

### Diamond Laps & Accessories .....

.....	75
-------	----

### Die Grinding Stones.....

.....	59, 60
-------	--------

### Die Grinders.....

.....	59
-------	----

## Diesel

Core Drills & Reamers .....	24
Guide Tooling .....	24, 26-28
Heat Tabs .....	52
Seat Installers .....	14
Spring Compressor .....	36
Super Abrasive .....	43
Valve Guides .....	24, 30
Valve Guide Tooling .....	24 - 33
Valve Seals .....	24, 35
Valve Seat Cutter Blades .....	6 - 9

### Dingleberry Hones .....

.....	28, 72, 93
-------	------------

### Disposable Assembly Wipes .....

.....	68, 71
-------	--------

### DOHC Organizer Tray.....

.....	61
-------	----

### DOHC Timing Chain Tensioner .....

.....	75
-------	----

### Double Angle Valve Seat Wheels .....

.....	18
-------	----

## Dowel Puller & Collets .....

.....	102
-------	-----

## Dressers

Abrasive Dresser.....	100
CBN Dressing Stick.....	102
Crankwheel Diamond Dressers .....	104, 105
Diamond Stone Dresser .....	83
Flywheel Dressers .....	102
Hand-Held Dressing Sticks .....	96
Premium Diamond Dressers.....	104, 105
Resurfacer Grinding Wheel Dressers .....	46
Cutter Assemblies .....	46, 102
Star Dressers .....	46, 102
Valve Seat Wheel Dressing Stands .....	NP-4, 20

## Drive Adaptors .....

.....	4, 13
-------	-------

## DVDs .....

.....	109
-------	-----

## Dykem® .....

.....	11, 15
-------	--------

## E

### Economy Head Holder .....

.....	57
-------	----

### Electric Head Straightening Oven .....

.....	54
-------	----

### Eliptibur Tool .....

.....	101
-------	-----

### Engine Pre-Lube Supplies .....

.....	71, 89
-------	--------

### Engine Balancing Supplies .....

.....	97
-------	----

### Engine Cart .....

.....	61
-------	----

### Engine Seal Tabs .....

.....	52
-------	----

### Epoxy, Porting .....

.....	59
-------	----

### Expanding Pilots .....

.....	2, 3
-------	------

### Extreme Pressure Lube .....

.....	71
-------	----

## F

### False Guides .....

.....	30, 126
-------	---------

### Fast Freeze .....

.....	11, 14, 86
-------	------------

### Feeler Gauges .....

.....	55, 123
-------	---------

### File, Diamond .....

.....	9
-------	---

### Filter Bag .....

.....	66
-------	----

### Filter Paper & Mats.....

.....	80
-------	----

### First Lube .....

.....	71
-------	----

### Flapwheels .....

.....	58, 59
-------	--------

### Flex-Hones® .....

.....	28, 72, 93, 114
-------	-----------------

### Fluid Weld® .....

.....	52
-------	----

### Flywheel Grinding

Bolt Adaptors .....	101
CBN Flywheel Stones & Dressing Stick.....	102
Coolant.....	73, 103
Dowel Puller & Collets.....	102
Depth Gauge .....	102
Dressers .....	102
Grinding Stones .....	102, 103
Mounting Adaptor .....	103

### Flywheel Saver Shims .....

.....	101
-------	-----

### Flywheel Step Gauge .....

.....	102
-------	-----

## Ford

Core Drills & Reamers .....	24
Flywheel Saver Shims .....	101
Smog Plugs.....	53
Torque Plates.....	75
Valve Guides .....	30

### Frost Plug Tools .....

.....	91
-------	----

## G

### Gasket Maker .....

.....	70
-------	----

### Gas Porting Tools.....

.....	86
-------	----

### Gauges .....

.....	20, 23, 33, 40, 121 - 124
-------	---------------------------

### Gel Lube .....

.....	40, 55
-------	--------

## General Motors (GM)

Cam Bolt Locking Plate.....	92
Flywheel Saver Shims .....	101
Vortec Adaptor Plate Set .....	53

<b>General Motors (cont.)</b>			
Vortec Seals	34, 35		
Vortec Seal Cutter	35		
<b>Glass Beading Supplies</b>	64		
<b>Glasses, Safety</b>	61, 65, 68		
<b>Gloves</b>			
Glass Bead	64		
Heat & Flame Resistant	54, 68		
Hot Tank Gloves	65		
Nitrile	68		
Parts Washing Gloves	68		
<b>Grind Aid</b>	44, 100		
<b>Grinding Stones &amp; Wheels (see Abrasives)</b>			
<b>Guide Knurling</b>			
Knurling Arbors	34		
Knurltube	34, 73		
OD Knurling Tool	27, 34		
<b>Guide Installers</b>	29, 30		
<b>Guide Liners</b>	33		
<b>Guide Tooling, Diesel</b>	24, 29		
<b>Guides</b>	30, 126, 131		
<b>H</b>			
<b>Hardness Tester</b>	93, 96		
<b>Harley-Davidson® (see V-Twin)</b>			
<b>Harmonic Dampener Installer</b>	101		
<b>Head Bolt Spot Facer</b>	34, 56		
<b>Head Holders</b>	57, 135		
<b>Head Saver Shims</b>	56		
<b>Head Stands</b>	57, 135		
<b>Head Straightening Fixture</b>	54		
<b>Head Straightening Oven</b>	54		
<b>Head-Bolt Hole Cleaners</b>	NP-, 51		
<b>Heat Tabs</b>	52		
<b>Heavy Metal</b>	97		
<b>Height Gauges</b>	20, 40, 123		
<b>High Performance</b>			
Cam Wheels	93		
CC-ing Equipment	42		
Gasket Maker & Thread Sealer	70		
Resurfacing Spray	43, 73		
Valve Grinding Aid	22, 73		
Valve Seat Cutter Blades	6 - 9		
Valve Spring Booster Shims	42		
Valve Spring Compressors	36 - 39		
Valve Spring Testers	NP-8, 41		
Valve Train Checking Springs	41		
<b>Hi-Temp Last Blast</b>	70		
<b>Hone Plates</b>	75, 134		
<b>Hone Stop Assembly</b>	79		
<b>Honing Oil</b>	73, 79, 91		
<b>Honing Stones</b>			
Cylinder Honing	76 - 81		
Pin Honing	83		
Rod Honing	82 - 83		
Valve Guide	26, 28		
<b>Hoses</b>	66, 118, 123		
<b>Hot Tank Detergents</b>	67		
<b>How-To Manuals &amp; Videos</b>	109		
<b>Hylomar® Gasket Maker &amp; Solvent</b>	70		
<b>Hyper Finish Diamond Guide Sizing</b>	26		
<b>I</b>			
<b>ID Tags</b>	69		
<b>IDL</b>			
Core Drills & Reamers	24		
Valve Refacer Wheels	22		
<b>Indexable Counterbore Cutters</b>	14		
<b>Indicators</b>	20, 40, 41, 97, 120, 123		
<b>Infinite Flow Cutting Tips (IFT)</b>	6		
<b>Instructional Manuals &amp; Videos</b>	109		
<b>Internal Calipers</b>	122		
<b>Iron-tite</b>	51, 52		
<b>J</b>			
<b>Jet Spray Cleaner</b>	67		
<b>Jet Valve Eliminator Kit</b>	51		
<b>Jet Washer Parts Baskets</b>	68		
<b>K</b>			
<b>Keeper-Keeper</b>	39, 63		
<b>Keeper Tools</b>	38 - 39, 134		
<b>Keyway Honing Stones</b>	78		
<b>Knurling</b>	34		
<b>KO Lee Type Pilots</b>	3		
<b>KO Lee Valve Refacer Wheels</b>	23		
<b>Kwik-Way</b>			
Belts	45, 109		
Boring Bar Cutters	74, 75		
Core Drills & Reamers	24		
Drive Adaptor	19, 21		
Expanding Pilots	2, 3		
Heavy Duty Dressing Stand	NP-4		
Rebuild Kit for KW Holders	NP-4, NP-5, 21, 109		
Resurfacer Wheel Segments	44		
Single-piece Resurfacer Wheels	46		
Solid Tapered Pilots	1, 2		
Stone Holders	NP-4, NP-5, 21		
Valve Refacer Wheels	22		
Valve Seat Grinder Motor Units	NP-2 - NP-5, 19		
Valve Seat Stones	16, 18		
<b>L</b>			
<b>Lap, Diamond</b>	9, 75		
<b>Lapping Compound</b>	15		
<b>Lapping Oil</b>	9, 58, 73, 75		
<b>Lapping Tools &amp; Compound</b>	15		
<b>Last Blast Paint</b>	70		
<b>Layout Fluid</b>	11, 15		
<b>Leak-Down Tester</b>	123		
<b>Letter Stamps</b>	69, 100		
<b>Levels &amp; Vials</b>	42, 43		
<b>Lifter Bore Tools</b>	91		
<b>Lifting Sling</b>	92		
<b>Lights</b>			
Black Lights	49, 50		
Inspection Lights	106		
LED Lights	106		
Light Bulbs	50		
Work Light	113		
<b>Liners, Guide</b>	33		
<b>Lisle® Honing Stone Sets</b>	76, 79		
<b>Litmus Paper</b>	67		
<b>Lubricants</b>			
Blood Friction Master®	71		
Brake Lubes	116		
Break-In Lube	71		
Cam-Shield® Assembly Lube	71		
Extreme Pressure Lube	71		
First Lube	71		
Flywheel Grinder Table Lubricant	73		
Way Oil	73		
<b>M</b>			
<b>Magnetic Bolt Washer Removers</b>	42		
<b>Magnetic Crack Detection</b>	48 - 50		
<b>Magnetic VAD Holder</b>	55		
<b>Magnetic Valve Spring Shim Removers</b>	42		
<b>Mallory</b>	97		
<b>Mandrels</b>			
Align Hone	81		
Butterfly Mandrels	58		
Cross Buff / Flap Wheel Mandrel	58, 59		
Diamond Sizing System	26		
Honing	NP-7, 76		
Rod Honing Mandrels	82, 83		
Roll Mandrels	58, 59		
<b>Manual Ring Grinders</b>	87		
<b>Manual Spring Compressors</b>	37 - 39, 134		
<b>Manual Vacuum Testers</b>	47		
<b>Manual Valve Guide Drivers</b>	29		
<b>Markers</b>	69, 70		
<b>Measuring Tools</b>			
Bore Gauges	122, 124		
Calipers	120		
Crankshaft Dial Indicator	97, 120		
Dial Indicators	20, 40, 41, 97, 120, 123		
Feeler Gauges	55, 123		
Flywheel Depth Gauge	102		
Leak Down Tester	123		
Micrometers	121		
Rod Bolt Stretch Gauges	124		
Setting Micrometers	5		
Small Hole Gauge Set	33, 124		
Straight Edges	54, 123		
Stroke Checker	96		
Telescoping Gauge Set	123		
Valve Seat Run-Out Gauge	11, 121		
Valve Seat Height Gauge	20, 123		
Valve Stem Concentricity Gauge	23		
Valve Stem Height Gauges	40		
Warp Alignment Gauge	54, 123		
<b>Metal Markers</b>	70		
<b>Micrometers</b>	121		
<b>Micro Biostat</b>	67		
<b>Minnesota Fast Freeze</b>	11, 14, 84		
<b>Mitutoyo®</b>			
Dial Bore Gauge	122		
Hole Gauge Set	33		
Split Ball Bore Gauge	33, 124		
<b>Mondello Seat Cutter Blades</b>	6		
<b>Motors</b>			
Brake Lathe	113, 117		
Crankshaft Polisher	100		
Seat Grinding	NP-2, NP-3, NP-4, NP-5, 19		
<b>Mounted Points</b>	59, 60		
<b>N</b>			
<b>Neway</b>			
Valve Seat Cutters	12		
Easy Turn Wrench	13		
Pilots	1 - 3		
Replacement Cutter Blades and Screws	12		
Solid Tapered Pilots	1		
<b>Nicasil Honing Stones</b>	80		
<b>Number Stamps</b>	69, 100		
<b>O</b>			
<b>O-Ring (Belt) for Kwik-Way</b>	109		
<b>O-Ring Cutters &amp; Accessories</b>	75		
<b>O-Ring Wire</b>	75		
<b>Off Road Motorcycle Parts</b>	131 - 133		
<b>Oil Filter Tools</b>	90		
<b>Oil Gallery Brushes</b>	62, 90		

# Index

Oil Gallery Tools	90
Oil Gallery Wax	90
Oil Pre-lube Tank	89
Oil Pump Belts	82, 108
Organizers	61, 134
Oven, Electric Rod Heater	88
Oven, Head Straightening	54
Oversize Bronze-Liners	33
Oversize Valve Guides	30, 126, 131
Oversize Valve Seat Inserts	14, 125

## P

<b>Paint</b>	
Last Blast Spray Paint	70
Markers	70
<b>Parts Cleaning</b>	
Airless Blaster Media	65
Baskets	65, 68
Brushes	62, 63, 90, 93
Detergent Powders	67
Glass Bead Tools & Supplies	64
Gloves	64, 65, 68
Hydro-Air Guns	64
Keeper-Keeper	39, 63
Multi-Purpose Parts Degreaser	67
Parts Tumbler Solution	65
Pro-Jet Spray Cleaning Powder	67
Roloc Bristle Discs	63
Super Scraper™	63
Tumbler Cleaning Media	65
Ultrasonic Detergents & Filters	67
Valve Stem Protectors	63
<b>Parts Storage &amp; Organizers</b>	
Baskets	65, 68
DOHC Cylinder Head Tray	61
Engine Cart	61
FT-RACK	7
Keeper-Keeper	39, 63
Organizer Trays	61, 134
Parts Tags & Marker	69
Plastic Bags	44, 69, 0
Safety Pins	69
Seat Cutter Blade Rack	7
Shrink Wrap	68
<b>Parts Tumbler Media</b>	65
<b>Parts Tumbler Rebuild Kit</b>	65, 106
<b>Pastelub™ Hi-Temp Brake Lube</b>	116
<b>Peening Tool</b>	96
<b>Peterson</b>	
Boring Bar Cutters	74
Core Drills & Reamers	24
Crankshaft Grinding Wheels	95
Cylinder Head Resurfacing Belts	45
Resurfacer Wheel Segments	44
Single-piece Resurfacer Wheels	46
<b>pH Test Strips</b>	67
<b>Pilots</b>	
Expanding	2, 3
Extended Length Top Solid-Tapered	3
Live	2
Micro	1, 2, 5
Serdi-Style	2
Solid-Tapered Steel	1
Split	3
Tapered Carbide	2
<b>Pin Bushing Press Kit</b>	84

<b>Piston Installing Tools</b>	
Deadblow Hammer	86
Electric Rod Heater	88
Gas-Fired Rod Heater	88
Piston Pin Installing Fixture	89
Ring Compressing Pliers	86
Rod Clamping Vise	89
<b>Piston Pin Removal Fixture</b>	85
<b>Piston Ring Filers</b>	87
<b>Plastigage</b>	96
<b>Plateau Honers</b>	28, 78, 81
<b>Plugs</b>	
Crack Repair	51
Deck Kit	92
Frost Plug Tools	91
Oil Gallery	90
Smog Plugs	53
<b>Pneumatic Tools</b>	
Air Hammer	29
Lapping Tool	5
Scraper	63
Valve Guide Drivers	29, 30
Valve Seat Grinder Driver	19
Valve Spring Compressors	36, 37
<b>Polishing Belts &amp; Rouge</b>	98 - 100
<b>Portable Cylinder Honers</b>	NP-7, 76
<b>Porting &amp; Polishing</b>	
Abrasives Kits	59
Abrasives Rolls with Integral Mandrels	59
Aluminum Oxide Cloth Shop Rolls	58
Butterfly Mandrels	58, 59
Carbide Burr Set	60
Crocus Cloth	58
Cross-Buffs®	58
Die Grinders	59
Epoxy	59
Flapwheels	58, 59
Mandrels	58, 59
Mounted Wheels	60
Port Reshaping Kit	59
Porting Kits	59
Porting & Polishing Machining Aid	58
Replacement Abrasives and Mandrels	58
Rotary Files	60
<b>Powered Ring Filer</b>	87
<b>Pre-Lube Tank</b>	89
<b>Premium Tapered Reamers</b>	106
<b>Pre-Oiler</b>	89
<b>Press Fit Lubricant</b>	30, 71, 86
<b>Press Kit, Tapered Pin</b>	84
<b>Pressure Lube</b>	71
<b>Pressure Tester Rust Inhibitor</b>	51
<b>Pro Jet Spray Cleaning Powder</b>	67
<b>Prussian Blue</b>	11, 15
<b>Pucks (VADs)</b>	55
<b>Pullers</b>	14, 35, 56, 102
<b>Pumps</b>	66

## Q

<b>Quick Mount Bar Set</b>	53, 108
----------------------------	---------

## R

<b>Radial Wire Brushes</b>	63
<b>Reamers</b>	
Bronze	25
Bronze Liner	32
Bronzwall	31
Carbide Valve Guide	25, 130

<b>Reamers (cont.)</b>	
Cobalt	25
Core	24
Diesel	24
High Speed Steel for Cast Iron	25
Piloted Core Reamers	24
Small Diameter	25, 130
Tapered	106
Titanium Coated Cobalt	25
<b>Reaming Oil</b>	34, 73, 130
<b>Rebuilding Kits</b>	
Parts Tumbler	65, 106
Spring Compressor	39
Stone Holder	NP-4, NP-5, 21, 109
<b>Reluctor Ring Installation Tool</b>	101
<b>Replacement Belt for B&amp;D Valve Refacer</b>	108
<b>Resurfacing Belts</b>	45
<b>Resurfacing Wheel Segments</b>	44
<b>Resurfacing Wheels</b>	46
<b>Resurfacing Coolant</b>	45, 46, 73
<b>Resurfacing Dressers</b>	46
<b>Resurfacing Spray</b>	43, 73
<b>Ring Band Compressors</b>	86
<b>Ring Expanders</b>	87
<b>Ring Grinders</b>	87
<b>Rocker Arm Tools</b>	56
<b>Rockwell Hardness Tester</b>	93, 96
<b>Rod and Cap Grinding Wheels</b>	83
<b>Rod Balancing Stand</b>	97
<b>Rod Bolt Boots</b>	89
<b>Rod Bolt Installing Block</b>	89
<b>Rod Bolt Stretch Gauge</b>	124
<b>Rod Clamping Vise</b>	89
<b>Rod Heaters</b>	88
<b>Rod Hone Filter Mat</b>	80
<b>Rod Honing Oil</b>	73, 82, 91
<b>Rod Honing Stones &amp; Guide Shoes</b>	82, 83
<b>Rod Hone Mandrels</b>	82, 83
<b>Roll Over Fixture</b>	53
<b>Roloc Bristle Discs</b>	63
<b>Rotary Broach Tool Bits</b>	45
<b>Rotary Files</b>	60
<b>Rottler</b>	
Boring Bar Cutters	74
Diamond Honing Stones	NP-6
Diamond Lap	75
Honing Stones	NP-6
Sleeve Cutters	74
Valve Refacer Wheels	23
<b>Rust Protection</b>	44, 66, 69

## S

<b>Safety Glasses</b>	58, 61, 65, 68, 96
<b>Safety Pins</b>	69
<b>Scales</b>	97
<b>Scrapers</b>	63
<b>Screws</b>	
Ball Head	4, 5
Boring Bar	74
Carbide Cutter	4, 5, 10
Catspaw	74
Cross Buff Mandrel	58
Feed Screws	113, 114, 115
Neway	12
<b>Scribe Tools</b>	11, 57, 135
<b>Seal-All™</b>	52
<b>Seals</b>	24, 35, 125
<b>Seal Cutters</b>	34, 130

Seal Pullers .....	35	Stones (cont.)		Trays, Organizing .....	61, 134
Seal Setters .....	35, 125	Honing .....	NP-6, 76 - 81	Tumbling Media .....	65
Seal Cutters .....	4 - 10, 12 - 14, 35, 40, 130	Porting & Polishing .....	60	<b>U</b>	
Seal Cutting Fluid .....	11, 73	Refacing .....	22, 23	Ultra-Finish Plateau Honing Tools .....	28, 78, 81
Seal Drivers .....	14	Resurfacing .....	44, 46	Ultrasonic Detergents & Filters .....	67
Seat Grinding (see Valve Seat Grinding)		Rod Honing .....	82, 83	Universal Checking Standards .....	121
Seat Removers .....	5, 14	Valve Seat .....	NP-2, NP-3, 16 - 18	Universal Dressing Stand .....	20
Segments .....	44	<b>Stroker Mimic™</b> .....	96	Universal Gel Lube .....	40, 55
Serdi Style Pilots .....	2	<b>Stud Extractor</b> .....	56	Universal Spring Pad Cutter .....	10, 40
Serdi-Style Bodies & Drivers .....	4, 13	<b>Stud Pullers</b> .....	56	Utility Rolls .....	58
Shim Stock .....	54	<b>Stud Stretchers</b> .....	43	<b>V</b>	
Shims, Flywheel Saver .....	101	<b>Sunnen®</b>		V-Twin	
<b>Shot</b>		Align Hone Mandrels .....	81	Double Head Plate .....	57, 135
Ceramic .....	65	Belts for Rod Honing Machines .....	82, 108	Decking Jig .....	NP-7
Glass .....	64	Cap Grinding Wheels .....	83	Harley Adaptor for Guide Driver .....	30
Steel .....	65	Core Drills & Reamers .....	24	Head Plate & Stand .....	57, 135
<b>Shop Towels</b> .....	68, 71	Cylinder Honing Stones .....	76 - 81	On-the-Engine Spring Compressor .....	39, 128
<b>Shrink Wrap</b> .....	69	Dial Bore Gauges .....	124	Organizer Tray .....	61, 134
<b>Silencer Brake Spray</b> .....	116	Guide Shoes .....	82, 83	Torque Plates .....	134
<b>Silencers, Brake Lathe</b> .....	112	Honing Head for Rod Machines .....	82	Valve Guides .....	126
<b>Sioux™ Replacement Parts</b> .....	21, 65, 106, 107	Lifter Bore Hones .....	91	Valve Guide Reamers .....	25, 130
<b>Sioux-Style</b>		<b>Sunnen® (cont.)</b>		Valve Seals .....	125
Drive Adaptor .....	19, 21	Main Bore Align Hone Mandrels .....	81	Valve Seat Cutter Blades .....	6 - 9
Drivers .....	NP-5, 19	Mandrel Drivers .....	81	Valve Seat Inserts .....	125
Pilots .....	1 - 3	Master Holder & Stone Supports .....	77	Valve Springs .....	128, 129
Stone Holders .....	NP-3, 18, 21	Oil Pump Belts .....	82, 108	Valves .....	127
Vacuum Plates .....	47, 107	Plateau Honing Tools, Ultra-Finish .....	78	<b>Vacuum Plates</b> .....	47, 107
Valve Refacer Wheels .....	23	Portable Cylinder Hones .....	76	<b>Vacuum Testers</b> .....	47
Valve Seat Grinding Kit .....	NP-3	Press-Fit Lubricant .....	86	<b>VADs</b> .....	55
Valve Seat Stone Removers .....	20	Replacement Parts for CV-616 .....	108	<b>Valve Adjustment Tools &amp; Discs</b> .....	55
Valve Seat Wheels .....	NP-3, 17 - 18	Rod Chamfer Cutters .....	82	<b>Valve Grinding</b>	
<b>Sizing Balls</b> .....	31 - 33	Rod Honing Stones & Guide Shoes .....	82, 83	Adaptor for ½" Chucks .....	23
<b>Sling, Lifting</b> .....	92	Truing Sleeves .....	28, 83, 91	Black & Decker Valve Refacer Collets .....	108
<b>Sludge Filter Bag (Sock)</b> .....	66	Valve Guide Hone Set .....	28	Bluing Fluid .....	11, 15
<b>Smog Plugs</b> .....	53	Valve Refacer Wheels .....	23	Diamond Dresser Tools .....	105
<b>Snap-on</b>		<b>Super Scraper™</b> .....	63	Machine Parts .....	107 - 109
Replacement Brake Lathe Cutting Tips .....	111	<b>Sure Shot® Sprayer</b> .....	66	Valve Grinding Aid .....	22, 73
Valve Refacer Wheels .....	23	<b>Surfacing</b>		Valve Grinding Oil .....	22, 73
Valve Seat Stones .....	18	Belts .....	45	Valve Refacer Wheels .....	22, 23
<b>Spark Plug Thread Chaser</b> .....	106	CBN Inserts .....	43	Valve Stem Concentricity Gauge .....	23
<b>Spot Facers</b> .....	34, 56	Coolants .....	45, 46	<b>Valve Guide</b>	
<b>Split Ball Bore Gauge</b> .....	33, 124	PCD Inserts .....	43	Bronze-Liners .....	32, 33
<b>Spray Assembly Lube</b> .....	55, 71	Segments .....	44	Bronze-Wall® & Bronze-Wall 2® .....	31
<b>Spring Compressors</b> .....	36 - 39, 128, 134	Wheels .....	46	Brushes .....	62
<b>Spring Compressor Rebuild Kit</b> .....	39	<b>Swedge Cutting Tool</b> .....	114	Core Drill / Reamer .....	24
<b>Spring Pad Cutters</b> .....	10, 40, 40	<b>Switches</b> .....	107, 109, 113, 117	Diamond Hone Set .....	26
<b>Spring Seat Cutting Tool</b> .....	34	<b>T</b>		Drivers .....	29, 30
<b>Spring Testers</b> .....	41	<b>Tapered Reamers (For Tie Rods, Ball Joints)</b> .....	106	Flex-Hones® .....	28, 72
<b>Stamps, Steel</b> .....	69, 100	<b>Tap Cleaner</b> .....	51	Gauge Set .....	33, 124
<b>Starrett</b>		<b>Tapered Pin Bushing Kit</b> .....	84	Guides .....	30, 126, 131
Crankgrinder Dial Indicator .....	97, 120	<b>Tapping Fluid</b> .....	51, 73	Hone Set .....	26, 28
Levels .....	43	<b>Taps</b>		Knurling Tools .....	34
<b>Steady Rest Shoes</b> .....	97, 108	Bronze-Wall .....	31	OD Chamfer Tool .....	27
<b>Steel Shim Stock</b> .....	54	Crack Repair .....	51	OD Knurling Tool .....	34
<b>Step Gauge</b> .....	102	Head Bolt .....	NP-7, 51	Plateau Hones .....	28, 81
<b>Stone Holders</b> .....	NP-2, NP-3, NP-4, NP-5, 18, 21	<b>Telescoping Gauge Set</b> .....	123	Reamers .....	25, 130
<b>Storage Bags</b> .....	44, 69, 70	<b>Temperature Indicator Crayons</b> .....	54, 88	Small Hole Gauge Set .....	31
<b>Storage Cart</b> .....	61	<b>Tensioner Stop Block</b> .....	75	Spot Facer .....	34, 56
<b>Storm-Vulcan</b>		<b>Thin Wall Bronze Liners</b> .....	33	Top Collars .....	27
Boring Bar Cutters .....	74	<b>Thread Chaser</b> .....	106	Top Cutters .....	34, 56
Crankshaft Grinding Wheels .....	95	<b>Timing Chain Tensioner</b> .....	75	Valve Guide Brushes .....	62
Resurfacer Wheel Segments .....	44	<b>Titanium Coated Cutting Tips</b> .....	111	<b>Valve Guides</b> .....	30, 126, 131
Resurfacing Carbide Cutter Tips .....	45	<b>Tooling Stands</b> .....	21, 122	<b>Valve Lapping Tools &amp; Supplies</b> .....	15
<b>Straight Edges</b> .....	54, 123	<b>Top Cutters</b> .....	34, 56		
<b>Stones</b>		<b>Torque-Angle Indicator</b> .....	56, 93		
Camshaft .....	93	<b>Torque Plates</b> .....	75, 134		
Crankwheel .....	95				
Flywheel .....	102, 103				

# Index

<b>Valve Refacing</b>	
Diamond Dressers .....	105
Wheels .....	22, 23
<b>Valve Seals</b> .....	24, 35, 125
<b>Valve Seal Work</b>	
Cutters .....	35, 130
Pullers .....	35
Seal Setters .....	35, 125
<b>Valve Seat</b>	
Basic Valve Seat Grinding Kits .....	NP-2, NP-3
Bounce Springs .....	20
Cutter Blades .....	6 - 10, 12
Cutter Drivers .....	4, 5, 13
Cutting Fluid .....	11, 73
Cutting System .....	4, 5, 10, 12
Dressers .....	105
Drivers .....	14
Inserts .....	14, 125
Layout Fluids .....	11, 15
Machining Aid .....	11
Minnesota Fast Freeze .....	11, 14, 86
Neway Seat Cutting System .....	12, 13
Nickel-Chrome Valve Seats .....	14
Removers .....	5, 14
Run-Out Gauges .....	11, 121
Stone Holders .....	NP-2, NP-3, NP-4, NP-5, 18, 21
Valve & Seat Scribe .....	11
Valve Seat Wheels .....	16 - 18, 21
<b>Valve Seat Cutter Blades</b> .....	6 - 9, 12
<b>Valve Seat Counterbore Cutters</b> .....	13, 14
<b>Valve Seat Insert Driver</b> .....	14
<b>Valve Seat Wheels</b> .....	NP-2, NP-3, 16 - 18, 21
<b>Valve Spring</b>	
Adaptors .....	37 - 39
Booster Shims .....	42
Calibrated Springs .....	41
Compressors .....	36 - 39, 128, 134
Diesel Valve Spring Compressor .....	36
Inserts .....	42
Keeper Installation Tools .....	39
Manual Valve Spring Bench .....	37
Pneumatic Compressor Retrofit Unit .....	36
Pneumatic Valve Spring Press .....	36
Rebuild Kit .....	39
Seat Cutters .....	6 - 10, 40
Spring & Retainer Kits .....	128 - 129
Testers .....	NP-8, 41
Valve Spring Inserts .....	42
Valve Spring Shim Remover .....	42
<b>Valve Stem</b>	
Concentricity Gauge .....	23
Dial Indicated Valve Stem Height Gauge .....	40
Protectors .....	63
<b>Valve Stem Oil Seals</b> .....	24, 35, 125
<b>Valve Seal Setter</b> .....	35, 125
<b>Valve Seal Drivers</b> .....	35, 125
<b>Valve Seal Pullers</b> .....	35
<b>Valves</b> .....	127, 132
<b>Van Norman</b>	
Boring Bar Cutters & Parts .....	74, 75
Core Drills & Reamers .....	24
Crankshaft Grinding Wheels .....	95
Flywheel Cutter .....	101
Replacement Brake Lathe Cutting Tips .....	111
Resurfacer Segments .....	44
Single-piece Resurfacer Wheels .....	46
Valve Refacer Wheels .....	23

<b>Vertical Mill Roll-Over Fixture</b> .....	53
<b>Vials</b> .....	42, 43
<b>Valve Seals</b> .....	24, 35, 129
<b>Vortec Tools</b> .....	35, 53

<b>W</b>	
<b>Warp Gauge</b> .....	54, 123
<b>Way Oil</b> .....	73
<b>Wear Sleeves</b> .....	13
<b>Welding Rods</b> .....	100
<b>Wire Wheels &amp; Brushes</b> .....	62, 63
<b>Wrist Pin Bushing Press Kit</b> .....	84

# Powersports Index

<b>A</b>	
<b>AV&amp;V® Brand Hard Parts</b> .....	125 - 133
<b>B</b>	
<b>Beehive Valve Springs</b> .....	128
<b>Black Tulip® Valves</b> .....	127, 132
<b>C</b>	
<b>Chrome Tulip Valves</b> .....	127, 132
<b>Carbide Valve Guide Reamers</b> .....	25, 130
<b>Compression Release Valves</b> .....	130
<b>Cylinder Hone</b> .....	76
<b>D</b>	
<b>Degree Wheel</b> .....	92
<b>F</b>	
<b>Flex-Hones®</b> .....	72
<b>H</b>	
<b>Hard Parts</b> .....	125 - 133
<b>Head Organizer Tray</b> .....	134
<b>Head Plate &amp; Stand</b> .....	135
<b>K</b>	
<b>Keyway Honing Stone Sets</b> .....	78
<b>M</b>	
<b>Manual Valve Spring Compressors</b> .....	37 - 39, 134
<b>Micro Ball Head Tooling</b> .....	5
<b>Micro Valve Seat Wheels</b> .....	17
<b>N</b>	
<b>Neway Valve Seat Cutting System</b> .....	12
<b>O</b>	
<b>OE-Style Seals &amp; Drivers</b> .....	35, 125
<b>On-The-Engine Spring Compressor</b> .....	39, 128
<b>P</b>	
<b>Pilots</b> .....	1 - 3, 5
<b>Porting Kits</b> .....	59
<b>Powered Valve Guide Driver Adaptor</b> .....	30
<b>R</b>	
<b>Reamers</b> .....	25, 130
<b>S</b>	
<b>Small Diameter Portable Honing Set</b> .....	76
<b>Spring Seat Cutting Tool for Pan/Shovel</b> .....	130
<b>T</b>	
<b>Torque Plates</b> .....	134
<b>V</b>	
<b>Valve Guides</b> .....	126, 130, 131
<b>Valve Seal Cutter</b> .....	130
<b>Valve Seals</b> .....	35, 125
<b>Valve Seat Cutter Blades</b> .....	6 - 9
<b>Valve Seat Inserts</b> .....	125
<b>Valve Spring Compressors</b> .....	36 - 39, 128, 134
<b>Valve Spring Shims</b> .....	128, 133
<b>Valve Train Hard Parts</b> .....	125 - 133
<b>Valves</b> .....	127, 132

# Replacement Parts

## Black & Decker

Chuck Belt .....	108
Seat Stones .....	18
Stone Holders .....	21
Valve Refacer Collets .....	108

## Kwik-Way

Belts .....	109
Seat Stones .....	16, 18
Stone Holders .....	21
Stone Holder Rebuild Kits .....	NP-4, NP-5, 21, 109
Valve Refacer Parts .....	109

## Sioux™

Belts .....	107
Driver Parts .....	107
Parts Tumbler Rebuild Kit .....	65, 106
Stone Holders .....	21
Wheel Dresser .....	107
Vacuum Tester Gauge & Plates .....	107
Valve Grinder Parts .....	107
Valve Refacer Parts .....	107

## Sunnen®

CV-616 Honing Machine Belts & Gears .....	108
Rod Honing Machine Belts .....	82, 108
Valve Refacer Steady Rest Shoes .....	108



# Brake & Tire Changer Index

## A

Abrasive Sleeves .....	113
Accu-Turn Replacement Parts.....	117
<b>Accu-Turn</b>	
Duck Heads .....	118, 119
Duck Head Inserts.....	NP-6, 119
Mount / Demount Heads.....	118, 119
Replacement Cutting Tips .....	111
Rim Protectors .....	NP-6, 119
<b>All Tool Tips</b> .....	111
<b>Ammco Replacement Parts</b> .....	113, 114, 115
<b>Ammco Style Drum Silencers</b> .....	112
<b>Ammco Tips</b> .....	111
<b>Arbor Nuts</b> .....	113
<b>Arbors</b> .....	113
<b>Automotive Brake Lathe</b>	
Mounting Adaptors .....	116, 117

## B

Balancer Cones .....	118
Backing Plates .....	116, 117
Bean Tips.....	111
Bean Replacement Parts .....	115
Bear Tips.....	111
Bell Clamps .....	116, 117
Bits .....	111
Brake Lubes .....	116
Brake Lathe Chatter Eliminators .....	112
Brake Lathe Cutting Tips .....	111
Brake Lathe Tip Holders .....	110
Brass Wear Inserts .....	115
Brazed Carbide Cutting Tools .....	112

## C

Captured Rotor Adaptor.....	117
Carbide Brake Lathe Tips .....	111
Centering Cones .....	116, 117
Centering Springs .....	117
Ceramlub™ .....	116
Chain Silencer.....	112
Clamp On Silencers.....	112
<b>Coats</b>	
Hold Down Cone .....	118
Inflator Hoses .....	118
Jaw Protectors.....	119
Mount / Demount Heads .....	119
Rim Protectors.....	119
<b>Cross Feed Dust Boots</b> .....	114
<b>Cross Feed Shear Gear</b> .....	114, 115

## D

Double Duty Tip Holders .....	110, 115
Double Tapered Centering Cones.....	116
Drive Pulleys & Belts.....	114
Drum Feed Screws & Nuts .....	113, 115, 116
Duck Heads .....	NP-6, 118, 119
Duck Head Inserts .....	NP-6, 119
Dust Boots .....	114

## E

Expansion Assemblies .....	115
----------------------------	-----

## F

Ford F-150 Mounting Adaptor .....	117
Feed Motor .....	117
Flex-Hones® .....	114
Flexible Arbor Spacers.....	113
FMC Replacement Parts .....	115
FMC Tips.....	111
Friction Silencers .....	112

## H

Hardspot Cutters .....	112
Hoffman Tips .....	111
Hold Down Cone .....	118
Honed Edge Tips .....	111
Horvath Tips .....	111
Hunter Tips .....	111

## I

Inflator Hoses .....	118
----------------------	-----

## J

Jaw Protectors .....	NP-6, 119
----------------------	-----------

## K

Kwik-Way Tips .....	111
---------------------	-----

## L

Late Model Rotor Adaptor.....	117
Lead Screw Bushing .....	115
Locking Knob .....	114, 115

## M

Magnetic Strap Silencers.....	112
Mount / Demount Heads.....	118, 119

## N

Neoprene Brake Lathe Silencer .....	112
Neoprene Spindle Boot .....	114

## P

Pastelub™ .....	116
Performance Tips .....	111
Pro-Cut Tips .....	111

## Q

Quick Chuck Mounting Adaptor Set .....	116
--	-----

## R

Right Angle Drive Assembly.....	113
Rim Protectors.....	NP-6, 119
Rotor Adaptors .....	117
Rotor Feed Screws.....	113, 115, 117
Rotor Silencers .....	112
Round Brake Lathe Tips .....	111
RTI Tips .....	111
Rubber Spindle Boots .....	114
Rubber Strap Silencers.....	112

## S

Screw Feed Dust Boots .....	114
Seals .....	115
Serpentine Drive Belts .....	114
Silencer Brake Spray.....	116
Silencer Bands.....	112
Snap-On Tips .....	111
Spacers.....	113
Spindle Boots .....	114
Springs.....	113, 117
Swedge Cutting Tool .....	114
Switches .....	113, 117

## T

Tip Holders.....	110
Tips.....	111
Tire Changer Hoses .....	118
Tire Changer Mounting Heads.....	NP-6, 118, 119
Titanium Coated Tips .....	111
Tooling Hold Down Pieces .....	115
Truck Adaptor Sets .....	117

## V

Van Norman & Rels Tips .....	111
Variable Speed Motor .....	117
VBG Tips .....	111

## W

Way Assembly .....	117
Wear Inserts .....	115
Wheel Balancer Cones.....	118

# Policies

## Pricing:

Prices are subject to change without notice. There is no minimum order. Orders are billed at the prices in effect at the time of shipping. Discounts are not available on Sunnen® products.

## Shipping:

Goodson ships orders the same day they are received. Orders received after hours, on weekends or holidays are shipped the next business day. You have several choices of shipping speed. Cost of shipping is based on total weight or package dimensions and the distance from our warehouse. Many changes have recently been implemented by shipping companies. Goodson is working with these companies to ensure you receive your orders promptly without additional cost.

■ **STANDARD:** Unless otherwise requested, we ship items up to 150 lbs. and up to 130" in combined width, length and height by US Postal Service, UPS or FedEx services. Items over the weight or size limit must go by common carrier.

■ **EXPRESS:** We can ship most items by air to arrive in your choice of 1, 2 or 3 days. Please note that Goodson is not responsible for weather related delays.



Upon receipt of your order, please inspect all cartons immediately for damaged or missing products before signing for the merchandise. Any packages received in a damaged condition should be rejected and/or noted at the time of receipt. The customer assumes all risk of lost or damaged products in transit and likewise, assumes responsibility for filing a claim with the carrier. Any damage must be reported within 5 days of receipt (delays in reporting damage will prevent the carrier from accepting responsibility for damage and you will then be held responsible for the merchandise). Goodson will assist you in any way we can to help with your claim to the carrier.

In the event that items are missing from your shipment, please contact Goodson within 3 business days. Contact Goodson at **1-800-533-8010**.

## Freight:

For orders shipped ground within the USA, you may deduct the freight charges on any jobber net invoice of \$800 or more if you pay within 30 days. However, Glass Beads, Steel Shot, Tumbler Media, Machines, Equipment, Bulk Liquids and Crankwheels are not included (shipped F.O.B. Winona, MN). Hazardous Materials, Dangerous Goods and Dimensional Shipping fees may apply on certain items. Please call to inquire.



## Terms:

- 1) A 1% discount is given on merchandise if payment is made within 15 days from invoice date. This discount applies to the merchandise amount only (not the total amount) on the invoice (not a statement). The discount amount is shown in the lower left hand corner of the invoice. This discount does not apply to statement payments and does not apply to credit card orders.
- 2) Invoices not paid in full within 30 days from the statement date are subject to a finance charge of 1.5% per month (18% per year).

## Credit & Debit Card Orders:

Goodson accepts MasterCard, Visa, American Express and Discover Card. For your security, credit card numbers are **NOT** kept on file. Credit card orders do not qualify for the 1% quick-pay discount.

## Check Acceptance:

In the unlikely event that your check is returned for insufficient or held funds, we will debit your checking account electronically for the face amount of the check plus the service fee allowed by your state's law. This allows us to resolve the problem without turning you over to a collection agency and harming your credit rating. The transaction will appear on your bank statement and no one will have to contact you about payment.

## Returns:

You may return any item, except special orders, within 60 days. We will do our best to correct any problems or to send a replacement. If an item was damaged through mis-use or modification, Goodson will not accept it as a return. Credits will only be issued after it is determined that the part is resellable or it is deemed defective.

To return an item, please follow these easy steps:

1. Enclose a note explaining why you're returning the product. Be sure to include your name and account number (you'll find this on your invoice)
2. Ship the item freight prepaid within 60 days from invoice date to  
**Goodson Tools & Supplies for Engine Builders**  
**ATTN: Returns**  
**156 Galewski Drive**  
**Winona, MN 55987**

For best results, please ship return merchandise by a trackable shipping method. Keep your receipt as it may be necessary to track the package if it is lost in transit. A 10% restocking fee applies on all returns unless the problem was the fault of Goodson. If so, the restocking fee is waived and shipping costs are reimbursed.

**ABRASIVES WARRANTY:** Abrasives have a shelf-life, therefore, all abrasives are warranted against manufacturing defects for 1 year from the date of original purchase.

## Privacy Policy:

All information that Goodson collects from its customers through purchases, credit applications or other transactions is kept private and is not disclosed to anyone except as permitted by law. Goodson will not sell or trade this information to anyone. Goodson will limit employee access to customers' private information to only those employees who need to know the information to provide products and services to you. Goodson maintains internal safeguards to protect our customer's non-public information. Please see our website [www.goodson.com/Privacy\\_policy/](http://www.goodson.com/Privacy_policy/) for details.

## International Sales:

All items shipped F.O.B. Winona, MN, USA. To find a distributor near you, visit [www.goodson.com](http://www.goodson.com).



Goodson currently has distributors in:

- Austria • Australia • Belgium • Canada • Chile • Colombia • Costa Rica
- Ecuador • El Salvador • Finland • France • Germany • Guatemala
- Honduras • Ireland • Italy • Mexico • Netherlands • New Zealand
- Norway • Poland • Puerto Rico • Spain • Suriname • Sweden
- Switzerland • Taiwan • Turkey • United Kingdom • Venezuela

## Resharpener & Resetting:

Goodson offers Resetting & Resharpener services for the following:  
• Diamond Dressers • Brake Lathe Cutting Tips • CBN & PCD Resurfacing Cutters • Rotary Broach Tool Bits for Van Norman  
Get more information and pricing by calling **1-800-533-8010**.





## Coolants and Lubricants

We don't stock one type of coolant and claim that it suits all types of grinding, nor do we carry one type of oil and try to sell it for every application. Each of our many types of coolants, lubricants and oils is formulated to deliver better results and longevity in its specific use. All of our coolants prolong the life of grinding wheels, retard corrosion and rancidity. Colors may vary.

### All-Purpose Grinding Coolant

A synthetic water soluble coolant that "Licks Rust". Dilute 30:1

Size	Yield	Jobber	Order No.
1 gallon	30 gallons	\$ 29.99	<b>CGC-1288</b>
5 gallons	150 gallons	144.99	<b>CGC-5288</b>

### Crank & Cam Grinding Coolant

Synthetic, non-nitrate, high lubricity coolant. Dilute 20:1

Size	Yield	Jobber	Order No.
1 gallon	20 gallons	\$ 33.99	<b>CGC-10</b>
5 gallons	100 gallons	149.99	<b>CGC-50</b>

### Multi-Duty Grinding Coolant

Medium-duty, low foaming, synthetic coolant with rust inhibitors. Safe for ferrous and non-ferrous metals alike. No nitrates, phenols, chlorine or sulfur. Dilute 30:1

Size	Yield	Jobber	Order No.
1 gallon	30 gallons	\$ 37.99	<b>GPC-10</b>
5 gallons	150 gallons	179.99	<b>GPC-50</b>

### Belt-Resurfacing Coolant

For all belt-type resurfacers with or without down-pressure. Dilute 30:1

Size	Yield	Jobber	Order No.
1 gallon	30 gallons	\$ 27.99	<b>SGB-10</b>
5 gallon	150 gallons	137.99	<b>SGB-50</b>

### Resurfacing Coolant

Non-foaming, non-nitrate coolant for single-piece or segmented wheels. Dilute 20:1

Size	Yield	Jobber	Order No.
1 gallon	20 gallons	\$ 29.99	<b>SGC-10</b>
5 gallons	100 gallons	129.99	<b>SGC-50</b>

### Flywheel Grinding Coolant

A synthetic rust inhibitor that prevents rancidity. For all flywheel grinders. Dilute 30:1

Size	Yield	Jobber	Order No.
1 gallon	30 gallons	\$ 41.99	<b>FG-1101-G</b>
5 gallons	150 gallons	149.99	<b>FG-1102-G</b>

## Cutting Oils

### Knurlube

Lubricate while knurling.

Size	Jobber	Order No.
½ pint	\$10.49	<b>WLB-46-G</b>
1 quart	14.79	<b>WLB-47-G</b>



### Valve Seat Cutting Fluid

High-silicone lube cuts drag on cutters for a better finish, longer tool life. Dilute 9:1

Size	Jobber	Order No.
1 pint spray	\$13.99	<b>SCF-2</b>
1 gallon	28.49	<b>SCF-10</b>



### Lap Oil

This very fine oil prolongs the life of diamond laps. A light coat cools, lubricates and prevents wear.

Size	Jobber	Order No.	Size	Jobber	Order No.
4.0 oz.	\$10.49	<b>LP-LO-4</b>	8.0 oz.	\$17.99	<b>LP-LO-8</b>



### Cutting Aids (Aerosol\*)

Helps tools cut through the hardest of metals. Clings to the surface of the tool, keeping it cool while prolonging its life.

Size	Jobber	Order No.
Cutting & Tapping Fluid	\$12.49	<b>CTF-14*</b>
Resurfacing Spray	11.99	<b>HPS-16*</b>



### Bronze Reaming Oil

Cuts bronze build-up while reaming. Longer tool life. Better valve guide finish.

Size	Jobber	Order No.
1 pint	\$ 9.99	<b>BW-303-G</b>
1 quart	15.99	<b>BW-303A-G</b>
1 gallon	35.99	<b>BW-305-G</b>



### Tap Oil

Makes tapping easier & faster. Breaks down surface tension. Eliminates scuff marks & gouging. Reduces tap breakage & improves thread quality.

Size	Jobber	Order No.
7.5 oz.	\$15.79	<b>TAP-O</b>



## Grinding & Honing Oils

### Cylinder Honing Oil (Clear)

Ideal for portable hones and all makes of automotive honing machines. Mixes readily with other brands (including Sunnen®). Not water soluble.

Size	Jobber	Order No.
1 gallon	\$ 26.99	<b>HO-10</b>
5 gallons	114.99	<b>HO-50</b>
55 gallons	Call	<b>HO-550</b>



### Diamond Honing Oil (Brown)

Specially formulated to withstand the cutting pressures created when using our Diamond Valve Guide Honing System.

Size	Jobber	Order No.
8 fl. oz.	\$ 5.29	<b>DHO-8</b>
1 gallon	38.99	<b>DHO-10</b>
5 gallons	174.99	<b>DHO-50</b>



### Rod Honing Oil (Dark Brown)

Keeps stones clean & free-cutting during rod reconditioning, pin fitting and other honing jobs. Will mix with other brands (including Sunnen®).

Size	Jobber	Order No.
1 gallon	\$ 34.99	<b>RHO-10</b>
5 gallons	174.99	<b>RHO-50</b>
55 gallons	Call	<b>RHO-550</b>



### Valve Grinding Oil (Light Yellow)

Universal valve grinding oil extends wheel life. Mineral based.

Size	Jobber	Order No.
1 gallon	\$ 29.99	<b>VGO-10</b>
5 gallons	119.99	<b>VGO-50</b>



### Titanium Valve Grinding Aid

Mix ratio of 1:4. Add to valve grinding oil.

Size	Jobber	Order No.
32 oz.	\$42.99	<b>VGA-T32</b>



### Severe Duty Valve Grinding Oil (Brown)

For grinding titanium, Inconel®, stainless steel and stellite valves.

Size	Jobber	Order No.
1 gallon	\$ 34.99	<b>VGO-SD10</b>
5 gallons	174.99	<b>VGO-SD50</b>



## Machine Lubricants

### Flywheel Grinder Table Lubricant

Helps extend flywheel grinder life. This high-pressure oil is designed to lubricate table bearings and ways. For all makes of flywheel grinders.

Size	Jobber	Order No.
1 gallon	\$39.99	<b>FG-1131-G</b>



### Way Oil

Adhesive oil formulated to provide extended lubrication and rust protection for machine-tool ways.

Size	Jobber	Order No.
1 gallon	\$29.99	<b>WO-50</b>



### Rust Shield for Shop Equipment

Prevents rust and won't cause rancidity. Protective film mixes with coolant so you don't have to clean it off before using the machine.

Size	Jobber	Order No.
1 gallon	\$27.99	<b>RS-128</b>



CYLINDER HEAD REBUILDING  
CLEANING, ASSEMBLY & SAFETY  
SHORT BLOCK REBUILDING  
FLYWHEEL GRINDING  
CRANKSHAFT/ FLYWHEEL GRINDING  
MISCELLANEOUS TOOLS & SUPPLIES  
BRAKE & TIRE CHANGING TOOLS  
MEASURING TOOLS  
V-TWIN & METRIC HARD PARTS

From our customers ...



"Thanks to all the folks at Goodson for the great products and service for our machine shop so quickly!" - Doug Herbert, Doug Herbert Racing via Twitter (@DougHerbert)

CYLINDER HEAD REBUILDING  
CLEANING, ASSEMBLY & SAFETY  
SHORT BLOCK REBUILDING  
CRANKSHAFT/ FLYWHEEL GRINDING  
MISCELLANEOUS TOOLS & SUPPLIES  
BRAKE & TIRE CHANGING TOOLS  
MEASURING TOOLS  
V-TWIN & METRIC HARD PARTS

## WINONA VAN NORMAN, VAN NORMAN, PETERSON, KI (PK447S)

### 1-EDGE CUTTER BIT

Fits Model Numbers	For	Bit Dia.	Jobber	Order No.
777, 900, 905, 944, 965	General	1/4"	\$38.99	VN-1
777S, 777S4, 944S, CB11, BC22XL	General	3/8"	38.99	VGS-1
	Hard Sleeves	3/8"	38.99	VGS-2
	Sleeve Cutter	3/8"	38.99	VGS-3
888, 999	General	7/16"	58.99	VN-360
	Sleeve Cutter	7/16"	58.99	VN-360C

### Original Van Norman

Fits Model Numbers	For	Bit Dia.	Jobber	Order No.
777S, 944S	Hard Sleeves	3/8"	\$49.99	777-179

### HOLDERS FOR 6-EDGE TIPS - Use RT-6B and RT-6BT

Fits Model Numbers	Length	Height	Jobber	Order No.
777, 900, 905, 944, 965	1 7/8"	3/4"	\$149.99	VN-135
	2 1/2"	3/4"	149.99	VN-136
777S, 777S4, 944S	2"	1 3/16"	159.99	VN-122
Bore Range: 2.65" to 4.50"				

### Standard Carbide Replacement Cutter Tip

8.99 RT-6B

### Titanium Coated Carbide Replacement Tip

9.99 RT-6BT

### Fits Model Numbers - Use FG-3B

CB11, CB22XL	3/8" diameter	\$79.99	VN-129
		9.99	FG-3B

### MISCELLANEOUS PARTS

Fits 6-Edge Holders Above	Description	Jobber	Order No.
	Bit Screw	\$3.29	VN-130
	Lock Screw	3.29	VN-132
	Nylon Ball	3.99	VN-133

## KWIK-WAY

### 1-EDGE CUTTER BIT FOR OE HOLDERS

Fits Model Numbers	Type	Bit Dia.	Jobber	Order No.
F, FT, FL, FN, FR, FS, FW, FWS, FWS1, FX	Rough	5/16"	\$29.99	KWL-R
	Finish	5/16"	29.99	KWL-F
Models After 1770	Sleeve Cutter	5/16"	29.99	KWL-C

### HOLDER FOR 6-EDGE TIPS - Uses RT-6B or RT-6BT Tips

Fits Model Numbers	Length	Height	Jobber	Order No.
FL, FN, FR, FS, FT, FW	2 9/16"	5/8"	\$134.99	KWL-116
			8.99	RT-6B
			9.99	RT-6BT

## PETERSON-BERCO

### 1-EDGE CUTTER BIT FOR OE HOLDERS

Fits Model Numbers	Length	Bit Dia.	Jobber	Order No.
ACP-151-A, ACP-151-BL, SCP-151-P	1 3/4"	10mm	\$33.99	PB-151

## ROTLER

### 1-EDGE CUTTER BIT FOR OE HOLDERS

Fits Model Numbers	Length	Bit Dia.	Jobber	Order No.
All Bars	1 3/4"	1 1/32"	\$21.99	RL-1
Sleeve Cutter for All Bars	1 3/4"	1 1/32"	21.99	RL-1C

### HOLDER WITH 3-EDGE TIP - Includes one RL-2T Tip

Fits Model Numbers	Length	Bit Dia.	Jobber	Order No.
All Bars	1 1/4"	1 1/32"	\$27.29	RL-2H
			3.49	RL-2S
			10.99	RL-2T

## STORM-VULCAN

### 1-EDGE CUTTER BIT FOR OE HOLDERS

Fits Model Numbers	Length	Bit Dia.	Jobber	Order No.
NS, BCG, BCT, 220, 260	3/4"	5/16"	\$41.99	S-1

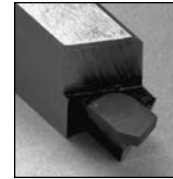

**Single-Piece (Solid) Style**  
Holder with integral cutting bit. Excellent cutting performance. Resharpener. When no longer usable, replace entire cutter.

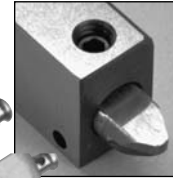

**1-Edge Replaceable Type**  
Tool holder with separate bit. Excellent cutting yet economical. Resharpener the cutter bit many times. When no longer usable, replace only the bit.

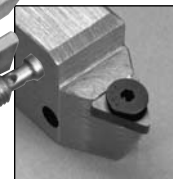

**6-Edge Replaceable Type**  
Lowest-cost choice. Holders take 6-edge, replaceable tips. When one edge wears, turn to new surface. Never need to resharpen - just replace the tip.

**The more you buy, the more you save!**

Order 10 - 29 Tips, save 10% off jobber  
Order 30 or more, save 20% off jobber

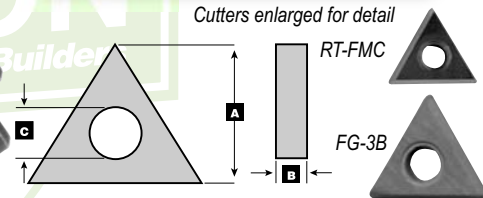

## Replacement Tips & Parts

• Fit most boring bar holders

A	B	C	Edges	Jobber	Order No.
<b>Standard Carbide</b>					
.358"	.097"	.108"	3	\$17.99	SEQ-1
.345"	.094"	.140"	6	8.99	RT-6B
.447"	.124"	.149"	3	3.69	RT-FMC
.360"	.094"	.124"	3	9.99	FG-3B
.327"	.094"	.140"	3	10.99	RL-2T
<b>Titanium Coated</b>					
.345"	.094"	.140"	6	\$9.99	RT-6BT

## Van Norman, Peterson or Kansas Instruments OE Catspaw Screws For 777S or PK-447S & 944S

Description	Jobber	Order No.
<b>Catspaw Screws (1 each)</b>		
For #1 Shoe (0.625"L)	\$8.99	800-114
For #2 Shoe (0.740"L)	8.99	800-115
For #3, 4 & 5 Shoe (0.940"L)	8.99	800-116

# Cylinder Boring & Honing

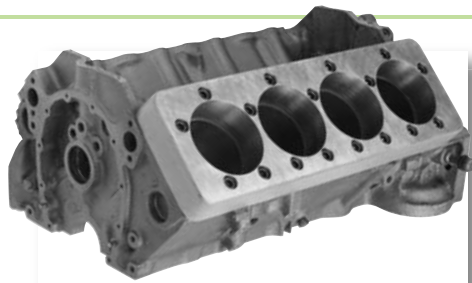

## tech tips

from the techxperts™

Head-bolt torque can distort cylinders as much as .004". If you bore and hone a cylinder without using a torque plate, expect up to this much head distortion. Torque plates create head-bolt stress and draw cylinders into their operating shape for boring or honing. Torque plates help you rebuild your block properly with greater precision.

**Bore hole size is .080" over standard bore size.**

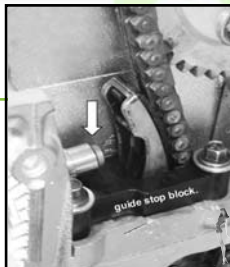

## Tensioner Stop Block for Chrysler 2.7 DOHC

- Eliminate broken timing chains, bent valves and chain backlash
- For VIN code R, U & V
- Mechanically supports hydraulic adjusters
- Use with plunger screw or bottom plate tensioners

Application	Jobber	Order No.
For <b>New</b> Chain & Tensioner	\$29.99	DT-27
For <b>Used</b> Chain (modifications may be required)	29.99	DT-27U

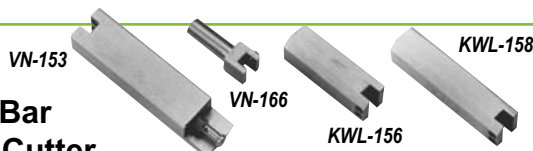

## Boring Bar O-Ring Cutter

### Replaceable Tool Bits & Holders

- Cut grooves for O-rings to enhance gasket sealing for high-performance engines
- Machines a groove .037" wide

Description	Application	Lng.	Ht.	Jobber	Order No.
Holders	WVN, VN, Peterson, KI	3 3/8"	1 3/16"	\$149.99	VN-153
		1 1/2"	3/8"	139.99	VN-166
	Kwik-Way	2 1/2"	5/8"	119.99	KWL-156
		2 1/2"	5/8"	124.99	KWL-158
Tool Bits	Standard			67.99	KWVN-57
	Premium			76.99	KWVN-57C6



## Torque Plates for Use with a Portable Bar

- Genuine BHH Torque Plates modified to GOODSON specifications
- Parallel blanchard ground • Heat-treated • Bolts included (unless noted)
- Bore size is .080" over standard bore size

Fits	Displacement	Material	Bolts	Jobber	Order No.
<b>Chevy – with Cap-Screw Bolts for tight clearances</b>					
V8 Small Block	265-350	Cast Iron	✓	\$379.99	HGM-1
V8 Small Block	400	Cast Iron	.060" over standard bore	389.99	HGM-1A
<b>Chevy – use your existing fasteners (washers / spacers provided)</b>					
LS-1	350	Billet Alum.		\$669.99	HGM-LS1
Big Block Bowtie (for bores up to 4.530")		Cast Iron		599.99	HCH-3-R-S
<b>Chrysler</b>					
V8 Small Block	273-360	Cast Iron	✓	\$399.99	HCR-4
V8 Big Block	361-440	Cast Iron	✓	449.99	HCR-6
<b>Ford</b>					
V8 Small Block	260-302	Cast Iron	7/16"	\$399.99	HFO-7
	351-400		1/2"		
V8 Big Block	429-460	Cast Iron	✓	399.99	HFO-9A

✓ Replacement Bolts and Washers are available



and Supplies for Engine Builders

## Diamond Laps & Accessories for Rottler

- A light lap oil coat cools and lubricates
- Remove build-up with lint-free cloth and Dressing Stick while lap rotates

### Diamond Laps

Machine	OD	ID	Jobber	Order No.
Rottler	1 3/4"	1/4"	\$188.99	LP-RFA

### Accessories

Very Fine Lap Oil (4 fl. oz.)	\$10.49	LP-LO-4
Very Fine Lap Oil (8 fl. oz.)	17.99	LP-LO-8
Dressing Stick	9.49	LP-DS

Other Diamond Laps available by Special Order



## special order

Other O-Ring Cutter Holders are available by Special Order

## tech tips

To avoid breakage, use the standard cutter (KWVN-57) on cast iron blocks only and the Premium (KWVN-57C6) cutter on hard blocks. CAUTION: Avoid column drop as this will break the tips as well.

## 1 lb. Roll Copper or Stainless Steel O-Ring Wire

- Copper: .0403" dia.
- Stainless: .0410" dia.

Description	Jobber	Order No.
Copper	\$77.49	OWC-0403
Stainless Steel	64.99	OWS-041



CYLINDER HEAD REBUILDING  
CLEANING, ASSEMBLY & SAFETY  
SHORT BLOCK REBUILDING  
CRANKSHAFT/ FLYWHEEL GRINDING  
MISCELLANEOUS TOOLS & SUPPLIES  
BRAKE & TIRE CHANGING TOOLS  
MEASURING TOOLS  
V-TWIN & METRIC HARD PARTS

### tech tips

from the techxperts™

- 1 - Extend the range of your hone with the Master Holder and Stone Supports on the bottom of page 77
- 2 - Use with 1/2" non-pistol grip drill
- 3 - Heavy Duty units can also be used in manual hone cabinets



**new**

**Goodson exclusive**

## Portable Cylinder Hone Mandrels



	Junior Midget	Midget	Junior	Standard	Heavy-Duty	Heavy-Duty
Brand	Sunnen®	Sunnen®	Sunnen®	Sunnen®	Sunnen®	Goodson
Honing Range	1.25" - 1.75"	1.75" - 2.00"	2.00" - 2.60"	2.50" - 5.50"	2.50" - 5.50"	2.50" - 5.50"
Drive Shank	2.00"	2.00"	2.00"	2.00"	2.00"	2.00"
Drive Extension	12.00"	12.00"	12.00"	12.00"	12.00"	12.00"
Thread	7/8" - 14	7/8" - 14	7/8" - 14	7/8" - 14	3/4" - 11	3/4" - 11
Order No.	SNJ-10	SN-75	JN-95	AN-112	AN-815	GH-2555
Jobber	\$577.49	\$461.99	\$459.99	\$493.43	\$671.99	\$549.99

NOTE: Goodson is only authorized to ship Sunnen® products within the Western Hemisphere

Tools and Supplies for Engine Builders



### Lisle® Small Diameter Portable Honing Set

- Precision built specifically for 1.75" to 2.75" diameter cylinders
- Stones measure 3 1/2" L (88.9mm)
- Set includes Hone plus 3 Sets of 180 grit Stones to fit full range (one set shown installed on hone), Allen wrench and Storage Case
- Order No. **HL-1600** Jobber \$219.99



### Replacement Stone & Wiper Sets

- Includes 2 stones & felt wipers
- Choose from grits below

80 Grit		280 Grit	
Range in/mm	Order No.	Range in/mm	Order No.
1.75"-2.20"/44.5-55.8	<b>HL-1644</b>	1.75"-2.20"/44.5-55.8	<b>HL-1638</b>
2.05"-2.50"/51.4-63.5	<b>HL-1645</b>	2.05"-2.50"/51.4-63.5	<b>HL-1639</b>
2.35"-2.75"/59.7-69.8	<b>HL-1646</b>	2.35"-2.75"/59.7-69.8	<b>HL-1640</b>
	Jobber \$19.99		Jobber \$19.99

180 Grit	
Range in/mm	Order No.
1.75"-2.20"/44.5-55.8	<b>HL-1641</b>
2.05"-2.50"/51.4-63.5	<b>HL-1642</b>
2.35"-2.75"/59.7-69.8	<b>HL-1643</b>
	Jobber \$19.99

## Honing Stones



- Sets have 2 holders with 4" integral stones and 2 holders with aluminum wipers
- Ideal for Cast Iron

Grit	Range	mm	Finish	Sunnen	Jobber	Order No.
<b>For Sunnen Junior Midget Hone (SNJ-10)</b>						
150 Grit	1.25" - 1.44"	31.8-36.6	45 Ra	-----	\$29.29	<b>SNJ1-J45</b>
	1.42" - 1.60"	36.1-40.6	45 Ra	-----	29.29	<b>SNJ2-J45</b>
	1.58" - 1.77"	40.1-44.9	45 Ra	-----	29.29	<b>SNJ3-J45</b>
400 Grit	1.25" - 1.44"	31.8-36.6	8 Ra	-----	29.29	<b>SNJ1-J87</b>
	1.42" - 1.60"	36.1-40.6	8 Ra	-----	29.29	<b>SNJ2-J87</b>
	1.58" - 1.77"	40.1-44.9	8 Ra	-----	29.29	<b>SNJ3-J87</b>
<b>For Sunnen Midget Hone (SN-75)</b>						
70 Grit	1.75" - 2.00"	44.5-50.8	120 Ra	S18-J17	\$24.79	<b>SN-100</b>
150 Grit	1.75" - 2.00"	44.5-50.8	45 Ra	S18-J45	24.79	<b>SN-200</b>
220 Grit	1.75" - 2.00"	44.5-50.8	32 Ra	S18-J55	24.79	<b>SN-300</b>
280 Grit	1.75" - 2.00"	44.5-50.8	20 Ra	S18-J65	24.79	<b>SN-500</b>
400Grit	1.75" - 2.00"	44.5-50.8	8 Ra	-----	24.79	<b>S18-J87</b>
<b>For Sunnen Junior Hone (JN-95)</b>						
70 Grit	2.00" - 2.20"	50.8-55.9	120 Ra	T20-J17	\$24.79	<b>JN-100</b>
	2.20" - 2.40"	55.9-60.9	120 Ra	U22-J17	24.79	<b>JN-101</b>
	2.40" - 2.60"	60.9-66.0	120 Ra	V24-J17	24.79	<b>JN-102</b>
150 Grit	2.00" - 2.20"	50.8-55.9	45 Ra	S20-J45	24.79	<b>JN-200</b>
	2.20" - 2.40"	55.9-60.9	45 Ra	U22-J45	24.79	<b>JN-201</b>
	2.40" - 2.60"	60.9-66.0	45 Ra	V24-J45	24.79	<b>JN-202</b>
220 Grit	2.00" - 2.20"	50.8-55.9	32 Ra	T20-J65	24.79	<b>JN-300</b>
	2.20" - 2.40"	55.9-60.9	32 Ra	U22-J55	24.79	<b>JN-301</b>
	2.40" - 2.60"	60.9-66.0	20 Ra	T20-J65	24.79	<b>JN-500</b>
280 Grit	2.00" - 2.20"	50.8-55.9	20 Ra	T20-J65	24.79	<b>JN-501</b>
	2.20" - 2.40"	55.9-60.9	20 Ra	U22-J65	24.79	<b>JN-502</b>
	2.40" - 2.60"	60.9-66.0	20 Ra	V24-J65	24.79	<b>JN-502</b>
400 Grit	2.00" - 2.20"	50.8-55.9	8 Ra	-----	27.79	<b>T20-J87</b>
	2.20" - 2.40"	55.9-60.9	8 Ra	-----	24.79	<b>U22-J87</b>
	2.40" - 2.60"	60.9-66.0	8 Ra	-----	24.79	<b>V24-J87</b>



## Goodson and Sunnen® Cylinder Honing Stones For all popular AN-style Honers and Hone Bodies

- Integral holder type sets have 4 pieces: 2 holders with stones and 2 holders with aluminum wipers • Fit Sunnen® AN Standard, AN Heavy-Duty and Goodson GH-2555 hones • Use with honing oil
- Stones for Short or Blind Holes are 2<sup>13</sup>/<sub>16</sub>" long; All other stones are 4" long
- Newly expanded selection of Goodson (HN) honing stones, includes many previously unavailable sizes

Bore Range				SUNNEN®			GOODSON			
Grit	in	mm	Usage	Finish	Jobber	Order No.	Sunnen No.	Jobber	Order No.	
70 Grit Roughing	2.5"-2.7"	63.5-68.6	Cast Iron	120 Ra	\$26.29	<b>AN-115</b>	G25-J17	<b>NEW</b> \$23.99	<b>HN-115S</b>	
	2.7"-4.1"	68.6-104.1	Cast Iron	120 Ra	26.29	<b>AN-100</b>	M27-J17	23.99	<b>HN-100S</b>	
Use Master Holder & Sleeve Support	3.5"-5.5"	88.9-139.7	Cast Iron	120 Ra				23.99	<b>HN-100R'</b>	
			Short/Blind	120 Ra	28.99	<b>AN-100-71</b>	M27-J17-71	23.99	<b>HN-102S</b>	
				Harley / VW	120 Ra	37.79	<b>AN-100F</b>	M27-J17	<b>NEW</b> 23.99	<b>HN-100F</b>
				Cast Iron	120 Ra	26.29	<b>AN-101</b>	N37-J17	23.99	<b>HN-101S</b>
				Cast Iron	120 Ra				23.99	<b>HN-101R'</b>
				Short/Blind	120 Ra	29.79	<b>AN-101-71</b>	N37-J17-71	23.99	<b>HN-104S</b>
				Hard Sleeves	55 Ra	26.29	<b>AN-131</b>	N37-J11	<b>NEW</b> 23.99	<b>HN-131S</b>
				Cast Iron	120 Ra	26.29	<b>AN-106</b>	W47-J17	<b>NEW</b> 23.99	<b>HN-106S</b>
				Hard Sleeves	55 Ra	26.29	<b>AN-136</b>	W47-J11	<b>NEW</b> 23.99	<b>HN-136S</b>
	Use Master Holder & Sleeve Support	2.5"-2.7"	63.5-68.6	Cast Iron	45 Ra	26.29	<b>AN-215</b>	G25-J45	23.99	<b>HN-215S</b>
Medium				2.7"-4.1"	68.6-104.1	Cast Iron	45 Ra	26.29	<b>AN-200</b>	M27-J45
				Short/Blind	45 Ra	26.29	<b>AN-200-71</b>	M27-J45-71	23.99	<b>HN-202S</b>
				Hard Sleeves	30 Ra				23.99	<b>HN-230S</b>
3.5"-5.5"		88.9-139.7	Cast Iron	45 Ra	26.29	<b>AN-201</b>	N37-J45	23.99	<b>HN-201S</b>	
			Short/Blind	45 Ra	29.79	<b>AN-201-71</b>	N37-J45-71	23.99	<b>HN-204S</b>	
			Hard Sleeves	30 Ra	26.29	<b>AN-231</b>	N37-J43	23.99	<b>HN-231S</b>	
				Cast Iron	45 Ra	26.29	<b>AN-206</b>	W47-J45	23.99	<b>HN-206S</b>
				Hard Sleeves	30 Ra	27.29	<b>AN-236</b>	W47-J43	23.99	<b>HN-236S</b>
220 Grit Finishing		2.7"-4.1"	68.6-104.1	Cast Iron	32 Ra	26.29	<b>AN-300</b>	M27-J55	23.99	<b>HN-300S</b>
	Short/Blind			32 Ra	28.99	<b>AN-300-71</b>	M27-J55-71	23.99	<b>HN-302S</b>	
				Cast Iron	32 Ra	26.29	<b>AN-301</b>	N37-J55	23.99	<b>HN-301S</b>
				Short/Blind	32 Ra	28.99	<b>AN-301-71</b>	N37-J55-71	23.99	<b>HN-304S</b>
			Cast Iron	32 Ra	26.29	<b>AN-306</b>	W47-J55	23.99	<b>HN-306S</b>	
Use Master Holder & Sleeve Support	2.5"-2.7"	63.5-68.6	Cast Iron	20 Ra	26.29	<b>AN-515</b>	G25-J65	23.99	<b>HN-515S</b>	
			Fine Finish	2.7"-4.1"	68.6-104.1	Cast Iron	20 Ra	26.29	<b>AN-500</b>	M27-J65
				Short/Blind	20 Ra	27.99	<b>AN-500-71</b>	M27-J65-71	23.99	<b>HN-502S</b>
				Hard Sleeves	12 Ra	26.29	<b>AN-530</b>	M27-J63	<b>NEW</b> 23.99	<b>HN-530S</b>
	3.5"-5.5"	88.9-139.7	Cast Iron	20 Ra	26.29	<b>AN-501</b>	N37-J65	23.99	<b>HN-501S</b>	
			Short/Blind	20 Ra	29.49	<b>AN-501-71</b>	N37-J65-71	23.99	<b>HN-504S</b>	
			Hard Sleeves	12 Ra				23.99	<b>HN-531S</b>	
				Hard Sleeves	12 Ra	25.79	<b>AN-536</b>	W47-J63	<b>NEW</b> 23.99	<b>HN-536S</b>
				Cast Iron	20 Ra	26.29	<b>AN-506</b>	W47-J65	<b>NEW</b> 23.99	<b>HN-506S</b>
	400 Grit Extra Fine Finish	2.5"-2.7"	63.5-68.6	Cast Iron	8 Ra	26.29	<b>G25-J87</b>	G25-J87	<b>NEW</b> 23.99	<b>HN-615S</b>
Cast Iron				8 Ra	26.29	<b>M27-J87</b>	M27-J87	23.99	<b>HN-600S</b>	
				Hard Sleeves	5 Ra	26.29	<b>M27-J85</b>	M27-J85	<b>NEW</b> 23.99	<b>HN-630S</b>
3.5"-5.5"		88.9-139.7	Cast Iron	8 Ra	27.29	<b>N37-J87</b>	N37-J87	23.99	<b>HN-601S</b>	
	Hard Sleeves		5 Ra	27.29	<b>N37-J85</b>	N37-J85	<b>NEW</b> 23.99	<b>HN-631S</b>		
Cork Polishing	2.5"-3.3"	63.5-83.8	Cast Iron*	2-3 Ra	32.79	<b>G25-C05</b>	G25-C05			
	3.3"-4.2"	83.8-106.7	Cast Iron*	2-3 Ra	58.29	<b>MM33-CO5</b>	MM33-CO5			
	4.0"-5.6"	101.6-142.2	Cast Iron*	2-3 Ra	44.99	<b>NN40-C05</b>	NN40-C05			

(\*Cast Iron – 3 Ra., Hard Sleeves – 2 Ra., Steel– 3 Ra.)



### Master Holder & Stone Supports

- Holds one 4" stone set
- Stones sold separately
- AN-365 requires use of AN-260

Master Holder			
Dia. Range	Jobber	Order No.	
4.7"-7.0"	\$125.49	<b>AN-355</b>	
6.0"-9.0"	127.99	<b>AN-365</b>	
Stone Supports for AN-365			
6.0"-9.0"	\$75.79	<b>AN-260</b>	

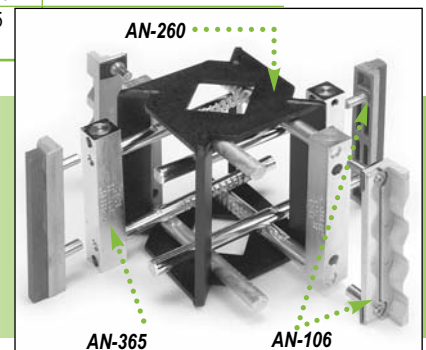

**The more you buy, the more you save!**  
Order 5 or more GOODSON HN Stones, save 10% off jobber



CYLINDER HEAD REBUILDING  
CLEANING, ASSEMBLY & SAFETY  
SHORT BLOCK REBUILDING  
FLYWHEEL GRINDING  
CRANKSHAFT/ MISCELLANEOUS TOOLS & SUPPLIES  
BRAKE & TIRE CHANGING TOOLS  
MEASURING TOOLS  
V-TWIN & METRIC HARD PARTS



"Turn to the Goodson website to find information and place orders from anywhere at any time."  
- Crystal, Advertising Department, 1 year of service

CYLINDER HEAD REBUILDING  
CLEANING, ASSEMBLY & SAFETY  
SHORT BLOCK REBUILDING  
CRANKSHAFT/ FLYWHEEL GRINDING  
MISCELLANEOUS TOOLS & SUPPLIES  
BRAKE & TIRE CHANGING TOOLS  
MEASURING TOOLS  
V-TWIN & METRIC HARD PARTS

## Keyway Honing Stone Sets

- Two-stroke engines have intake and exhaust ports that interrupt the operation of your honing stone
- These stones allow the hone to pass the intake and exhaust ports while maintaining consistent pressure to remove material accurately and easily
- Use with any AN- or GH-series hone (p. 76)
- For Cast Iron



Grit	Range	mm	Finish	Jobber	Order No.
150 Grit	2.5" - 3.3"	63.5-83.8	45 Ra	\$49.49	GY25-J45
Medium	3.3" - 4.2"	83.8-106.7	45 Ra	46.99	MY33-J45
280 Grit	2.5" - 3.3"	63.5-83.8	20 Ra	49.49	GY25-J65
Fine Finish	3.3" - 4.2"	83.8-106.7	20 Ra	46.99	MY33-J65
400 Grit	2.5" - 3.3"	63.5-83.8	8 Ra	49.49	GY25-J85
Extra Fine	3.3" - 4.2"	83.8-106.7	8 Ra	46.99	MY33-J85

## EHU type stones



## Stones & Shoes for Sunnen Hone Machines

- Premium-quality replacements for all CV-616, and CK-10 hones equipped with Sunnen Master Holder Sets
- Diameter Range: 4.125" - 5.000"/ 104.8 - 127.0mm
- Use with Master Holder Set CK-3045A (sold separately)
- 2 stones per set

new

Stones		Goodson - 1 set		Sunnen - 6 sets	
Use	Grit RMS	Jobber	Order No.	Jobber	Order No.
Hard Blocks	70 60	\$13.79	GEHN-116	\$83.49	EHN-116
Air Cooled Cyl.	70 60	13.79	GEHN-123	92.79	EHN-123
Hard Blocks	220 22-32	13.79	GEHN-512	92.79	EHN-512
Air Cooled Cyl.	220 22-32	13.79	GEHN-518	88.99	EHN-518
Hard Blocks	70 60	13.79	GEHU-123	78.49	EHU-123
Roughing	70 60	13.79	GEHU-133	78.49	EHU-133
Hard Blocks	220 22-32	13.79	GEHU-518	78.49	EHU-518
Gen. Purp.	220 22-32	13.79	GEHU-525	78.49	EHU-525
Aluminum	220 30-36	13.79	GJHU-525	78.49	JHU-525
High Nickel	280 20-25	13.79	GJHU-623	78.49	JHU-623
Finishing	280 16-23	13.79	GJHU-625	78.49	JHU-625
High Nickel	400 7-14	13.79	GJHU-818	78.49	JHU-818
Aluminum	400 7-14	13.79	GJHU-820	78.49	JHU-820
Accessories			Qty.	Jobber	Order No.
Sunnen® Master Holder Set			1	\$256.79	CK-3045A
Sunnen® Centering Guide (includes CK-3070)			1	112.49	CK-3090A
Sunnen® Guide Shoe & Screw Set			1	17.99	CK-3070
Wear Shoe			2	31.49	C-3070K
Stabilizing Shoe			2	27.99	C-3120K

For Rod Honing Stones and Shoes see page 83



C30-PHT-731

## Ultra-Finish Plateau Hones

- For Portable Hones, Hone Cabinets and CV/CK Tooling
- Abrasive impregnated nylon bristles
- Ideal for high-performance rebuilding and rebuilding newer style engines that use low-tension rings
- Superior plateau finish so rings will seal immediately
- Reduces break-in time
- Allows closer tolerances for improved compression, better oil control, lower emissions
- Fits AN- or GH-series hones

For Portable Hones and Hone Cabinets – Includes 1 pair

Hone Body	Dia. Range	mm	Jobber	Order No.
Sunnen SN	2.15" - 2.40"	54.6-60.9	\$334.99	SN-PHT-732
Sunnen JN	2.40" - 2.60"	60.9-66.0	389.99	JNO-PHT-732
AN / GH	2.98" - 3.78"	75.7-96.0	264.99	GG-PHT-732
Style	3.78" - 4.68"	96.0-118.9	275.79	MM-PHT-731
	4.48" - 6.08"	113.8-154.4	274.99	NN-PHT-731

For Sunnen CV / CK Hone Heads – Includes 1 pair

Head	Dia. Range	mm	Jobber	Order No.
Standard	3.10" - 5.00"	78.7-127.0	\$140.79	C30-PHT-731

For the best possible finish, use a Hone Stop (page 79)



## Sunnen® Tooling for Honing Dart Blocks & Ductile Sleeves

- Recommended for Dart™ Machinery
- Use with Sulfurated Rod Honing Oil (RHO-10 or RHO-50, p. 73) for all stone applications below

Description	Jobber	Order No.
<b>Honing Stone Sets For Portable Tooling</b>		
80 Grit	\$26.29	N37-A25
220 Grit	26.29	N37-A55
280 Grit	26.29	AN-501
400 Grit	38.79	MM33-J85
<b>For CK/CV Type Machines</b>		
80 Grit Stone Set (6)	\$ 91.79	C30-A25
150 Grit Stone Set (6)	91.79	C30-A45
220 Grit Stone Set (6)	91.79	C30-A55
280 Grit Stone Set (6)	91.79	C30-J65
400 Grit Stone Set (6)	91.79	C30-J85
Carbide Guide Shoe (1)	150.29	CK-3570
Delron Guide Shoe (1)	114.79	CK-3070NY3X



For CK & CV Machines, DO NOT use Bronze Guide Shoes, use from the Techxperts™ Titanium and Delron shoes above (1 of each)



# Cylinder Boring & Honing

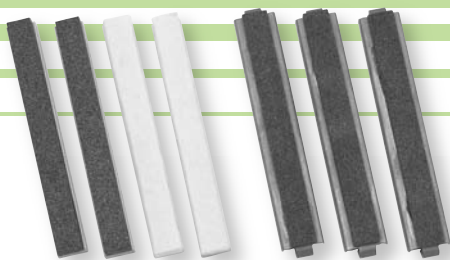

## Original Ammco Honing Stone Sets

### For Ammco 500 Hones

- Includes 2 stones and 2 felt wipers
- Use dry for best performance
- 1/2"W x 4"L

Grit	Qty	OE #	Order No.
60	4	#619	AHS-70
220	4	#620	AHS-220
320	4	#3933	AHS-280
400	4	#621	AHS-400

Jobber \$69.99

### For Ammco 3800 Hones

- Includes 3 stones
- Use liberal amounts of honing oil
- Clip on • 3/4"W x 4"L

Grit	Qty	OE #	Order No.
100	3	#4040	AHS-110
180	3	#3840	AHS-111
280	3	#3810	AHS-112
400	3	#3833	AHS-113

Jobber \$52.99

## Lisle® Honing Stone Sets

- Clip-on style mounts in seconds
- 5"/127mm long stones and wipers
- Each set contains two stones and two felt wipers
- Use dry

Replaces Lisle® No.	Grit	Order No.
15500	80	HL-80
15510	180	HL-180
15520	280	HL-280
15590	500	HL-500

Jobber \$15.99 per set



## Clear Honing Oil

- Helps keep stones clean and free-cutting
- Ideal for portable hones and all makes of automotive honing machines
- Mixes easily with other brands, including Sunnen®
- Not water soluble

Size	Jobber	Order No.
1 gal./3.78L	\$ 26.99	HO-10
5 gal./18.9L	114.99	HO-50



## tech tips

We recommend using liberal amounts of honing oil when using most honing stones (including Flex-Hones® and Ultra-Finish Plateau Hones), but as happens with most things, there are exceptions to the rule.

**DO NOT** use honing oil when you are using honing stone sets with felt wipers (such as the Ammco 500 stones and Lisle® stones above). The honing oil causes the felts to pack up and collapse, which leaves the stones without the necessary tension to keep them centered in the bore. When this happens you will end up with cylinder bell-mouthing and chatter.

When using diamond honing stones or you are honing Nicasil, be sure to use a high-pressure honing oil such as our Rod Honing Oil (RHO-10, RHO-50) or Diamond Honing Oil (DHO-10, DHO-50).

## 82°, 3" Dia. Chamfering Cones & Mandrel

- Chamfer sharp edges for safe piston and ring installation • Handles all diameter cylinders or sleeves
- 82° abrasive cones measure 3 1/2"/88.9mm high with 2"/50.8mm base and 3"/76.2mm top diameter
- Fits 3/8"/9.53mm or larger drill • Kit (CC-100) includes mandrel and three 50 Grit Aluminum Oxide cones (CC-15)



Description	Jobber	Order No.	Incl.
3" Top Dia. Chamfering Cone Kit	\$55.79	CC-100	▼
Replacement 3/8" Drill Adaptor	14.29	CC-100-1	x
<b>Aluminum Oxide Chamfering Cones (red)</b>			
40 Grit	\$8.49	CC-14	
50 Grit	8.49	CC-15	x
80 Grit	8.49	CC-20	
<b>Premium Zirconia Chamfering Cones (blue)</b>			
50 Grit	\$8.49	CCZ-15	
80 Grit	8.49	CCZ-20	

Order 5 or more cones, save 10% off jobber



## 45°, 5"/127mm dia. Chamfering Cones & Mandrel

- Large diameter cones chamfer the top of the cylinder to an exact 45° angle in one pass
- 1/2"/12.7mm steel shank permanently embedded in the base
- Cone height: 3 1/2"/88.9mm
- Kit includes mandrel & one 36-grit cone

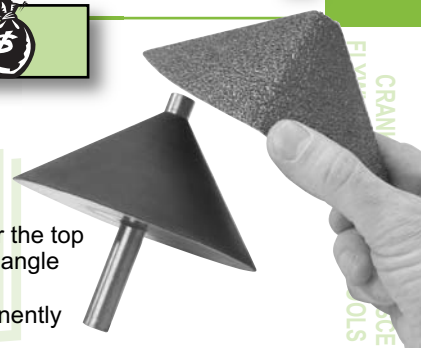

Description	Jobber	Order No.	Incl.
5" Chamfering Cone Kit	\$120.79	CC-130	▼
<b>Chamfering Cones</b>			
<b>Abrasive</b>	<b>Grit</b>		
Aluminum Oxide (red)	36	\$8.49	CC-30
	50	8.49	CC-50
	80	8.49	CC-80
Premium Zirconia (blue)	36	10.49	CCZ-36
	50	10.49	CCZ-50
	80	10.49	CCZ-80

## One-Set Hone Stop Assembly

- Stop-collar meets the deck, preventing the hone from hitting webs and damaging stones or block
- Use full, even strokes to avoid cylinder taper
- Hardened brass thrust bushing
- Includes nylon stop collar
- Set the depth once for faster manual honing



Bushing ID	Jobber	Order No.
1/2" (12.7mm)	\$139.99	HS-150-1/2
5/8" (15.9mm)	139.99	HS-150-5/8
Replacement 5" Diameter Nylon Stop Collar	43.99	HS-RING

CYLINDER HEAD REBUILDING  
CLEANING, ASSEMBLY & SAFETY  
SHORT BLOCK REBUILDING  
CRANK FLYWHEELS  
ACCESSORIES & SUPPLIES  
BRAKE & TIRE CHANGING TOOLS  
MEASURING TOOLS  
V-TWIN & METRIC HARD PARTS

"Your company should hold a seminar on how to run a company. I received your products the day following my order. When ordering from other companies they tell me it'll be 2-4 weeks because they are busy. It's nice to have great service these days. Thank you and keep up the great work!"

- Ray Temple, Waupaca, Wisconsin, Goodson customer since 2009

CYLINDER HEAD  
REBUILDING

CLEANING,  
ASSEMBLY & SAFETY

SHORT BLOCK  
REBUILDING

CRANKSHAFT/  
FLYWHEEL GRINDING

MISCELLANEOUS  
TOOLS & SUPPLIES

BRAKE & TIRE  
CHANGING TOOLS

MEASURING  
TOOLS

V-TWIN & METRIC  
HARD PARTS

## Honing Stones for Nicasil

- Deglaze Nicasil cylinders with portable hones
- 150 Grit Aluminum-Oxide abrasive
- Resizing cylinders requires diamond abrasive
- Hones on page 76

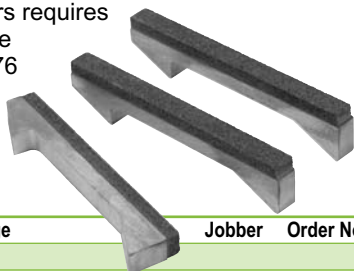

Honing Stone Range	Jobber	Order No.
<b>SNJ-Style Hone</b>		
1.250" - 1.437" / 32 - 37mm	\$28.49	<b>SNJ1-A43</b>
1.418" - 1.604" / 36 - 41mm	28.49	<b>SNJ2-A43</b>
1.580" - 1.770" / 40 - 45mm	28.49	<b>SNJ3-A43</b>

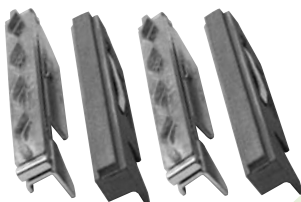

SN-Style Hone	Jobber	Order No.
1.550" - 2.000" / 44 - 51mm	\$28.49	<b>S18-A43</b>



JN-Style Hone	Jobber	Order No.
2.000" - 2.200" / 51 - 56mm	\$27.79	<b>T20-A43</b>
2.200" - 2.400" / 56 - 61mm	28.49	<b>U22-A43</b>
2.400" - 2.600" / 61 - 66mm	28.49	<b>V24-A43</b>

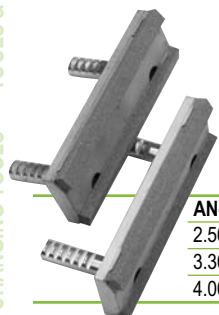

AN-Style Hones	Jobber	Order No.
2.500" - 3.300" / 64 - 84mm	\$38.99	<b>GG25-A43</b>
3.300" - 4.200" / 84 - 107mm	38.99	<b>MM33-A43</b>
4.000" - 5.600" / 102 - 142mm	38.99	<b>NN40-A43</b>

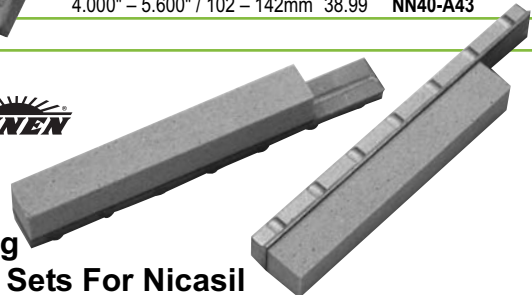

## Honing Stone Sets For Nicasil

- For deglazing Nicasil with A CV/CK Honing Machine
- Diameter Range:
  - 3.0" - 5.0" / 76.2-127.0mm in standard automotive head
  - 2.6" - 3.5" / 66.0-88.9mm in junior head
- 150 grit aluminum oxide abrasive
- 6 per set • Order No. **EHU-412** Jobber \$81.99

## tech tips

from the techxperts™

## Tips for Honing Nicasil

Nicasil is an electro-deposited (electroplated) composite of nickel and silicon carbide. Components are uniformly dispersed throughout the resulting material. Care must be used when honing this material as the plating is normally applied in thicknesses no greater than .003". If you remove too much of the Nicasil, you will need to have the cylinder bores replated. The wear ratio on Nicasil is 10:1 so .010" wear in a normal cylinder would be only .001" on Nicasil.

An aluminum-oxide abrasive is necessary for honing Nicasil as silicon-carbide is a part of the material and abrasives will not cut materials of similar density and composition.

We recommend using our Rod Honing Oil when working on Nicasil. The additives that make it ideal for high pressure honing also help the aluminum oxide abrasive cut cleaner and faster on a Nicasil surface.

If you have any other questions about honing Nicasil, be sure to call one of the Techxperts™ at Goodson 1-800-533-8010.

Order 3 or more Flex-Hones® (mix & match) and save 10% off jobber



## Standard Duty 240 Grit Aluminum Oxide Flex-Hones®

Inch	mm	Jobber	Order No.	Inch	mm	Jobber	Order No.
2 1/4"	57.2	\$35.29	<b>BA-225240</b>	3 1/4"	82.5	\$55.79	<b>BA-325240</b>
2 3/8"	60.2	37.29	<b>BA-237240</b>	3 1/2"	88.9	59.29	<b>BA-350240</b>
2 1/2"	63.5	37.79	<b>BA-250240</b>	3 3/4"	95.3	63.79	<b>BA-375240</b>
2 5/8"	66.5	40.49	<b>BA-262240</b>	4 1/8"	104.8	67.99	<b>BA-418240</b>
2 3/4"	69.8	42.49	<b>BA-275240</b>	4 3/8"	117.5	75.79	<b>BA-462240</b>
3"	76.2	49.49	<b>BA-300240</b>				

More Flex-Hones® on page 72

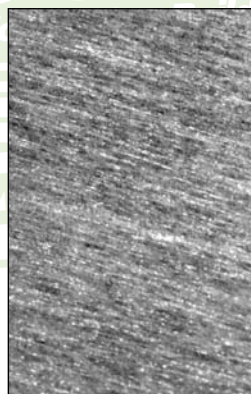
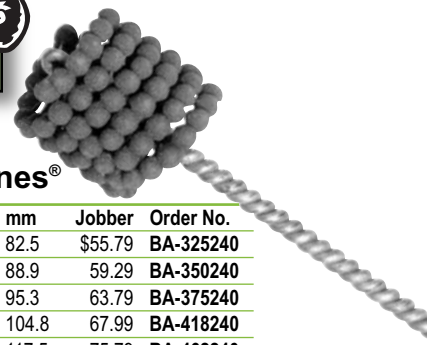

## Hone Cabinet Filter Paper

- Reduce sump and filter clean-up
- Extend oil life
- Filter paper in the bottom of hone machine removes debris before oil enters the sump
- When full, dispose of properly
- 2 - 60" x 60" sheets (trim to fit)
- Order No. **HN-FP** Jobber \$19.99

## 1" Thick Rod Hone Filter Mat

- Synthetic material
- Traps abrasive particles & metal filings BEFORE they enter the storage tank
- Cushions parts to prevent damage
- Replace when clogged
- 1"/25.4mm thick

Inches	Metric	Jobber	Order No.
18"x25"	45.7x63.5 cm	\$15.99	<b>RH-MAT</b>
26"x40"	66.0x101.6 cm	21.99	<b>RH-MAT-2</b>
33"x48"	83.8x121.9 cm	24.99	<b>RH-MAT-3</b>

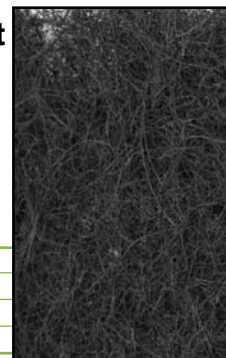

# Cylinder Boring & Honing



## Hone High-Silicon Aluminum Alloy Blocks With Ease – Honing Stones & Silicon Compound

- Stones fit both the Sunnen® AN-112 and AN-815 and the Goodson GH-2555 Portable Honing Mandrels
- Use each stone set progressively until the final bore size is achieved
- To create the final condition, coat the felt set and the honed cylinder surface with the Silicon Compound (AN-30) and lap the cylinders
- After completion, the cylinder will have a dull matte finish
- Piston and rings will ride on silicon instead of aluminum

Description	Hone Dia. 2.5"-3.3"		Hone Dia. 3.3"-4.2"	
	Jobber	Order No.	Jobber	Order No.
Roughing (280 grit)	\$41.99	GG25-J65	\$38.79	MM33-J63
Finishing (400 grit)	41.99	GG25-J85	38.79	MM33-J85
Polishing (600 grit)	52.49	GG25-CO5	58.29	MM33-CO5
Felt Set	62.99	GG25-FO5	62.99	MM33-FO5
Silicon Compound	57.79	AN-30	57.79	AN-30



## Mandrel Driver for Portable Use of CR-, PL- and ML-Series Honers

- Ideal for spindle bushings mounted on axles and other jobs that can't be taken to the honing machine
- For holes 3/4"/19.05mm ID and larger, where length is at least 3 times the diameter
- ID Range: .744" - 3.875"/19mm - 98mm
- Graduated adjustment knob advances and retracts stones • 275 - 450 RPM range
- Use with any 1/2"/12.7mm drill or larger
- Order No. **GGN-150** Jobber \$699.99



## Mandrel Driver for Align Honing Machines

- For Sunnen® CH-100 & similar align honing machines
- Graduated adjustment knob advances and retracts honing stones
- Quick release lever allows hone removal and installation without resetting
- Stone pressure adjusts with dial
- Automatically advances stones during honing
- **NOT** for portable honing applications
- Order No. **CH-75A** Jobber \$999.99

## tech tips

*Right Hand Rotation Only.*

For best results, keep your RPM about the same from the techxperts™ as your hone RPM, use the same rate of speed and number of strokes per minute.

## Ultra-Finish Plateau Soft Hones

- Remove microscopic peaks and scuffs without enlarging bores • Use with a portable drill • Abrasive impregnated nylon bristles • Ideal for high-performance engine rebuilding and for newer style engines that use low-tension rings
- Use after honing
- Gives a superior plateau finish so rings seal immediately, reducing break-in time
- Small sizes ideal for valve guide work
- Allows closer tolerances for improved compression, better oil control, lower emissions
- For best results, use liberal amounts of honing oil (**HO-50**, pg. 73) • **NOT** interchangeable with Flex-Hones®

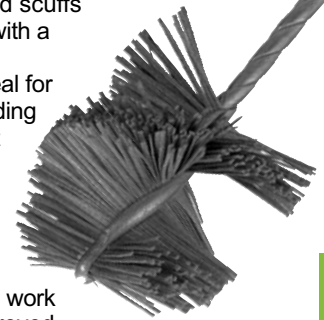

Hole Diameter	Hone	Head	Overall		
in	mm	Dia.	Length	Length	Jobber Order No.
.2187"	5.5	.241"	1.00"	4.00"	\$ 9.79 UF-5.5MM
.2500"	6.4	.275"	1.25"	4.50"	9.79 UF-6.4MM
.2813"	7.0	.309"	1.25"	4.50"	10.99 UF-7MM
.3125"	8.0	.343"	1.25"	4.50"	10.99 UF-8MM
.3437"	9.0	.378"	1.25"	4.50"	10.99 UF-9MM
.3750"	10.0	.413"	1.25"	4.50"	10.99 UF-10MM
.4375"	11.0	.481"	1.25"	4.50"	10.99 UF-11MM
.4688"	12.0	.516"	1.25"	4.50"	10.99 UF-12MM
.5000"	13.0	.550"	1.50"	5.00"	12.29 UF-13MM
.5625"	14.0	.618"	1.50"	5.00"	12.29 UF-14MM
.6250"	16.0	.688"	1.50"	5.00"	12.29 UF-16MM
.6875"	17.5	.756"	1.50"	5.00"	12.29 UF-17.5MM
.7500"	19.0	.825"	1.50"	5.00"	12.29 UF-19MM
.8125"	20.5	.893"	1.50"	6.00"	12.29 UF-20.5MM
.875"-1.00"	22-25	1.250"	2.00"	10.00"	44.99 UF-100
1.00"-1.25"	25-32	1.500"	2.00"	10.00"	45.99 UF-125
1.25"-1.75"	32-45	2.000"	2.00"	10.00"	47.29 UF-175
1.75"-2.25"	45-57	2.500"	2.00"	10.00"	48.79 UF-200
2.25"-2.75"	57-70	3.000"	3.00"	10.00"	48.79 UF-250
2.50"-3.00"	63-76	3.500"	4.00"	14.00"	57.79 UF-300
3.00"-3.50"	76-89	4.000"	4.00"	14.00"	59.99 UF-350
3.50"-4.00"	89-102	4.500"	4.00"	14.00"	59.99 UF-400
4.00"-4.50"	102-114	5.000"	5.00"	14.00"	62.99 UF-450



## Main Bore Align Hone Mandrels

- For the Sunnen® CH-100 Line Honing Machine
- Hone unit includes 1 set of 10 stones and 1 set of 20 shoes (replacement stones & shoes available)

Range	mm	Mandrels		Shoes (10/box)	
		Jobber	Order No.	Jobber	Order No.
2.4"-2.7"	61-69	\$2,799.99	10RY-2400G	\$69.99	RG-D
2.7"-3.0"	69-77	2,899.99	10RY-2700G	69.99	RG-D
3.0"-3.5"	77-89	2,999.99	10RY-3000H	74.99	RH-D
Stones 5/box		\$79.99	RY24-J49 (recommended for cast iron)		
fit all mandrels above		79.99	RY24-J45 (recommended for aluminum)		

More stones and shoes are available by special order, call to inquire.  
1-800-533-8010

CYLINDER HEAD REBUILDING  
CLEANING, ASSEMBLY & SAFETY  
SHORT BLOCK REBUILDING  
CRANKSHAFT/FLYWHEEL GRINDING  
MISCELLANEOUS TOOLS & SUPPLIES  
BRAKE & TIRE CHANGING TOOLS  
MEASURING TOOLS  
V-TWIN & METRIC HARD PARTS

# From our customers

"I bought your regular honing oil, and it does a fine job and it cuts well, however, when I found out the RHO honing oil might be a better deal, I began taking gallons of RHO honing oil and adding it to my tank to make it hone better, and sure enough I found that by adding the RHO honing oil the stones cut faster without clogging."

- George Livergood, Action Machine Shop, Goodson customer since 2010

CYLINDER HEAD REBUILDING  
CLEANING, ASSEMBLY & SAFETY  
SHORT BLOCK REBUILDING  
CRANKSHAFT/ FLYWHEEL GRINDING  
MISCELLANEOUS TOOLS & SUPPLIES  
BRAKE & TIRE CHANGING TOOLS  
MEASURING TOOLS  
V-TWIN & METRIC HARD PARTS

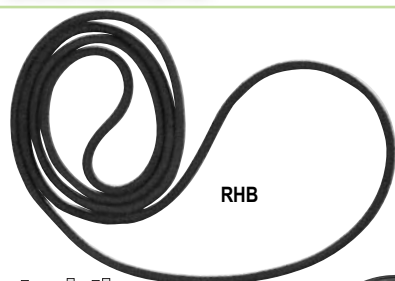

## Goodson Belts for Sunnen® Rod Honing Machines

- Top-quality belts for long life

### tech tips

from the techxperts™

You must measure the belt you are replacing. Ordering is based on length, not machine model. If your belt size doesn't match one in the chart, order the next size down. For example, if your belt measures 72 1/2", order the 70" Oil Pump Belt. Belts stretch over time so the shorter belt will fit.

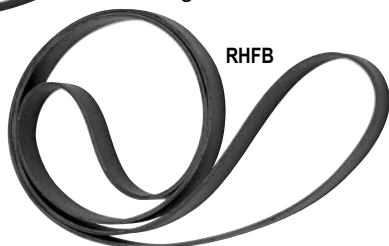

Size	Jobber	Order No.
<b>Oil Pump Belts (round)</b>		
70"/1.78m	\$89.99	<b>RHB-70</b>
74"/1.88m	89.99	<b>RHB-74</b>
79"/2.00m	89.99	<b>RHB-79</b>
84"/2.13m	89.99	<b>RHB-84</b>
85"/2.16m	89.99	<b>RHB-85</b>
109"/2.77m	99.99	<b>RHB-109</b>
<b>Flat Belts</b>		
37 1/4"x5/8"/945.9x15.9mm	\$ 99.99	<b>RHFB-37</b>
45 1/2"x5/8"/1155.7x15.9mm	109.99	<b>RHFB-45</b>
46 1/2"x5/8"/1181.1x15.9mm	109.99	<b>RHFB-46</b>



## Honing Head for Rod Machines

- For small engines & removable cylinders
- Accurate to .0005"
- Fits most popular rod honing machines
- Ideal for small engines or those with removable cylinders such as air-cooled VW or motorcycles
- Uses Goodson HN- or Sunnen AN-style honing stones (pg. 77)
- Order No. **AN-600**  
Jobber \$999.99



Shown with optional honing stones



## Rod Honing Oil

- Includes additives for high pressure cutting
- Keeps stones clean and free-cutting during rod reconditioning, pin fitting and other honing applications
- Will mix with other honing oils (including Sunnen®)

Size	Jobber	Order No.
1 gal./3.78L	\$ 34.99	<b>RHO-10</b>
5 gal./18.9L	174.99	<b>RHO-50</b>



## CR-Series Mandrels, Stones & Replacement Parts

- Recondition rods to factory specs
- Produces a round, straight rod bore for a perfect bearing fit • Mandrels ship with wedge plate, wedge, tension block, shoe clamps and guide shoes (replacement parts available separately) • Honing stones sold separately

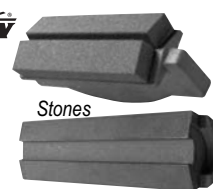

Stones

Guide Shoe

CR Series Mandrels		Jobber	Order No.
Range			
Inch	mm		
1.45" - 1.60"	36.8 - 40.6	\$419.99	<b>CR-1450</b>
1.60" - 1.75"	40.6 - 44.4	419.99	<b>CR-1600</b>
1.75" - 1.90"	44.4 - 48.3	419.99	<b>CR-1750</b>
1.90" - 2.10"	48.3 - 53.3	451.49	<b>CR-1900</b>
2.10" - 2.30"	53.3 - 58.4	451.49	<b>CR-2100</b>
2.30" - 2.50"	58.4 - 63.5	451.49	<b>CR-2300</b>
2.50" - 2.70"	63.5 - 68.6	514.49	<b>CR-2500</b>
2.90" - 3.10"	73.7 - 78.5	587.99	<b>CR-2900</b>

Honing Stones for manual honing			
Sunnen® Stones for CR-1450 to 1750 Mandrels (2/box)	Medium Finish	\$24.29	<b>CR-2</b>
	Fine Finish	24.29	<b>CR-4</b>
Goodson Stones for CR-1450 to 1750 Mandrels (1/box)	Medium Finish	10.99	<b>HC-2</b>
	Fine Finish	10.99	<b>HC-4</b>
Sunnen® Stones for CR-1900 & larger Mandrels (2/box)	Aluminum / Titanium	24.29	<b>CR-9</b>
	Roughing	24.29	<b>CR-10</b>
	Medium Finish	24.29	<b>CR-12</b>
	Fine Finish	24.29	<b>CR-14</b>
For Power Hone	Roughing	28.49	<b>CR-10N</b>
Goodson Stones for CR-1900 & larger Mandrels (1/box)	Roughing	11.79	<b>HC-10</b>
	Finishing	11.79	<b>HC-12</b>
	Fine Finish	<b>NEW</b> 11.79	<b>HC-14</b>

Sunnen® Guide Shoes (2 per box)			
Fit CR-1450 to 1750 Mandrel	Die Cast	\$ 8.29	<b>CR-40D</b>
Fit CR-1900 & larger	Die Cast	12.99	<b>CR-50D</b>
	Bronze	37.99	<b>CR-50B</b>

Goodson Guide Shoes (2 per box)			
Fit CR-1450 to 1750 Mandrel	Die Cast	\$ 9.49	<b>C-40D</b>
Fit CR-1900 & larger	Die Cast	10.79	<b>C-50D</b>
	Bronze	31.99	<b>C-50-BR</b>

Sunnen® Wedge & Wedge Plates			
Fit CR-1450 to 1750 Mandrel	Wedge	\$60.99	<b>CR-70</b>
	Small Plate	28.99	<b>CR-75</b>
	Large Plate	28.99	<b>CR-85</b>
Fit CR-1900 to 2500 Mandrel	Wedge	34.49	<b>CR-100</b>
Fit CR-1900 & larger	Small Plate	31.49	<b>CR-110</b>
	Large Plate	31.49	<b>CR-120</b>
Fit CR-2900 Mandrel	Wedge	42.99	<b>CR-200</b>

Sunnen® Tension Block			
Fits CR-1900 & larger		\$13.79	<b>LN-1337A</b>

Sunnen® Shoe Clamps (4 plus screws)			
Fits CR-1900 & larger		\$94.99	<b>CR-45A</b>



Rod Chamfer Cutters			
Use in place of stone on CR-Mandrels to chamfer large ends			
Fits CR-1450 to 1750	Cutter with tip	\$129.99	<b>CR-35</b>
Fits CR-1900 & larger	Cutter with tip	129.99	<b>CR-25</b>
	Replacement 3-edge Carbide Tip	68.29	<b>CR-28A</b>
Larger Mandrels, Stones and Replacement Parts are available by Special Order. Call 1-800-533-8010 for details.			

# Rod Honing Stones & Mandrels



## KL-Series Lifetime Honing Units For Connecting Rods (Pin Fitting)

- Replaceable shoe means the mandrel never wears out
- Stone & Shoe are of proper length to produce straight, round, accurate holes • Choose stones from chart below
- Special orders are available, call **1-800-533-8010** for details

Adaptor

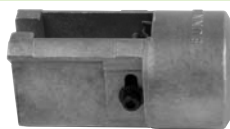

Mandrel includes 1 guide shoe



Truing Sleeve



Mandrel



**KL Mandrels** (Order Truing Sleeve, Adaptor & Hone Stones separately)

Range (in)	(mm)	Mandrel Includes Wedge & 1 Guide Shoe			Truing Sleeve		Adaptor Includes Retainer		Guide Shoes (2) Mandrel Includes 1 Shoe	
		Jobber	Order No.	Sunnen® No.	Jobber	Order No.	Jobber	Order No.	Jobber	Order No.
0.775"-0.805"	19.7 - 20.4	\$83.99	<b>KL-775M</b>	AK20-775UA	\$15.29	<b>S-775</b>	\$36.79	<b>AK20-A</b>	\$40.99	<b>UA-B</b>
0.838"-0.868"	21.3 - 22.0	83.99	<b>KL-838M</b>	AK20-838UB	16.29	<b>S-838</b>	36.79	<b>AK20-A</b>	40.99	<b>UB-B</b>
0.869"-0.899"	21.1 - 22.8	83.99	<b>KL-869M</b>	AK20-869UB	16.29	<b>S-869</b>	36.79	<b>AK20-A</b>	40.99	<b>UB-B</b>
0.900"-0.930"	22.1 - 23.6	83.99	<b>KL-900M</b>	AK20-900UC	16.29	<b>S-900</b>	36.79	<b>AK20-A</b>	41.49	<b>UC-B</b>
0.962"-0.993"	24.4 - 25.2	83.99	<b>KL-962M</b>	AK20-962UC	16.29	<b>S-962</b>	36.79	<b>AK20-A</b>	41.49	<b>UC-B</b>
0.994"-1.062"	25.2 - 27.0	94.49	<b>KL-1000M</b>	AK20-1000UD	16.29	<b>S-994</b>	36.79	<b>AK20-A</b>	41.49	<b>UD-B</b>
1.056"-1.125"	26.8 - 28.6	104.99	<b>KL-1062M</b>	AK20-1062UD	17.99	<b>S-1062</b>	36.79	<b>AK20-A</b>	41.49	<b>UD-B</b>
1.181"-1.250"	30.0 - 31.7	94.49	<b>KL-1187M</b>	AK20-1187UE	17.99	<b>S-1187</b>	36.79	<b>AK20-A</b>	31.79	<b>UE-B</b>

**NOTE:** Sunnen® has changed their part numbers. We have listed the Sunnen industrial number to the right of our order number for your convenience.



## Rod and Cap Grinding Wheels

- Recessed design
- Fits Sunnen® Rod and Cap Grinding Machines

Size	Jobber	Order No.
4"x1½"x1"	\$42.99	<b>GR-305</b>
101.6x38.1x25.4 mm		
6"x2"x1¼"	99.99	<b>GR-805</b>
152.4x50.8x31.8 mm		



## Delta Cap Cutter Premium Grinding Wheel

- Fits Delta Cap Cutter Model #6200XHD
- 7" OD x 1½" thick x 5½" ID
- Plate mounted & balanced for smooth grinding
- Ideal for welded main caps
- Order No. **GR-6200XHD**
- Jobber \$167.99

## Rod Honing Stones and Guide Shoes

- Premium-quality • Choose Goodson or Sunnen®



Stones	Use	Goodson			Sunnen®		
		Jobber	Order No.	Qty.	Jobber	Order No.	Sunnen No. Qty.
<b>For Sunnen® SL720 - SL2300 Mandrel</b>							
	Roughing	\$11.29	<b>HS-5</b>	1	\$89.29	<b>SL-5</b>	6
	General Purpose	11.29	<b>HS-7</b>	1	89.29	<b>SL-7</b>	6
	Finishing	11.29	<b>HS-13</b>	1	89.29	<b>SL-13</b>	6
<b>For Sunnen® PL Series Mandrel</b>							
	Roughing	\$6.79	<b>HP-5</b>	1	\$77.79	<b>PL-5</b>	P28-J27 12
	General Purpose	6.79	<b>HP-7</b>	1	77.79	<b>PL-7</b>	P28-J47 12
	Finishing	6.79	<b>HP-13</b>	1	77.79	<b>PL-13</b>	P28-J67 12
<b>For Sunnen® ML Series Mandrel</b>							
	Roughing	\$6.29	<b>HM-5</b>	1	\$77.79	<b>ML-5</b>	P20-J25 12
	General Purpose	6.29	<b>HM-7</b>	1	77.79	<b>ML-7</b>	P20-J47 12
	Finishing	6.29	<b>HM-13</b>	1	77.79	<b>ML-13</b>	P20-J67 12
<b>For Sunnen® KL Series Mandrel</b>							
	Roughing	\$6.29	<b>HK-5</b>	1	\$77.79	<b>KL-5</b>	K20-J25 12
	General Purpose	6.29	<b>HK-7</b>	1	77.79	<b>KL-7</b>	K20-J47 12
	Finishing	6.29	<b>HK-13</b>	1	77.79	<b>KL-13</b>	K20-J67 12
	Steel				77.79	<b>KL-14</b>	K20-A69 12
<b>Bronze Guide Shoes</b>							
<b>For Sunnen® KL and ML Series Mandrel</b>							
	.775"- .805"	19.7-20.4mm			\$40.99	<b>UA-B</b>	2
	.838"- .899"	21.3-22.8mm			40.99	<b>UB-B</b>	2
	.900"- .993"	22.9-25.2mm			41.49	<b>UC-B</b>	2
	.994"-1.125"	25.2-28.6mm			41.49	<b>UD-B</b>	2
	1.119"-1.250"	28.4-31.8mm			41.79	<b>UE-B</b>	2
<b>Note:</b> Bronze guide shoes outlast die cast 6 to 1.							
<b>Zinc Alloy Guide Shoes</b>							
<b>For Sunnen® PL and ML Series Mandrel</b>							
	1.355" - 1.500"	34.4-38.1mm			\$18.99	<b>WC-D</b>	2
	1.480" - 1.625"	37.6- 41.3mm			18.99	<b>WD-D</b>	2

## Diamond Stone Dresser

- Diamond stone on durable metal tool
- Order No. **MAN-700**
- Jobber \$89.99



CYLINDER HEAD REBUILDING  
CLEANING, ASSEMBLY & SAFETY  
SHORT BLOCK REBUILDING  
CRANKSHAFT/ FLYWHEEL GRINDING  
MISCELLANEOUS TOOLS & SUPPLIES  
BRAKE & TIRE CHANGING TOOLS  
MEASURING TOOLS  
V-TWIN & METRIC HARD PARTS

# From our customers

"This tool works!"

- Dennis Terrill, Terrill Motor Machine, Fort Lauderdale, FL, Goodson customer since 1990

CYLINDER HEAD REBUILDING  
CLEANING, ASSEMBLY & SAFETY  
SHORT BLOCK REBUILDING  
CRANKSHAFT/ FLYWHEEL GRINDING  
MISCELLANEOUS TOOLS & SUPPLIES  
BRAKE & TIRE CHANGING TOOLS  
MEASURING TOOLS  
V-TWIN & METRIC HARD PARTS



Choose from standard Wrist Pin Bushing Drivers. Sizes range from 25mm up to 54mm. If we don't have the size you're looking for in the chart below, we can create special drivers. Call the Goodson Techxperts™ at 1-800-533-8010 for more information

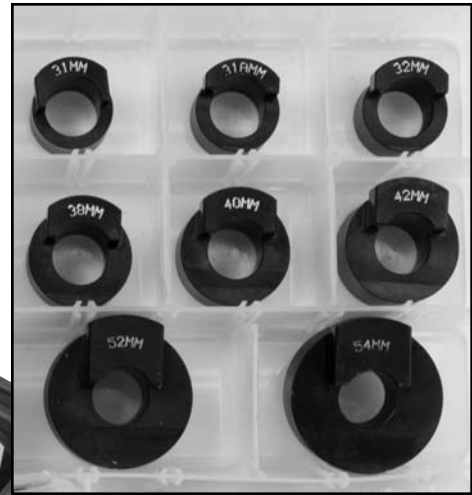

For easy identification, each Wrist Pin Bushing Drivers has the size stamped on it



sized for diesel

**American Made**

## Universal Tapered Pin Bushing Press Kit For Light & Medium Duty Diesel Engines

This press kit is specially designed to remove and replace tapered bushings in most common light to medium duty diesel applications. Don't spend time making a fixture that's dedicated to a single size. Our Tapered Pin Bushing Press Kit is ready to go when you receive it. All you need is the correct bushing driver to get started.

## tech tips

from the techxperts™  
When pressing together always press the rod onto the bushing and NOT the bushing into the rod. This prevents the bushing from collapsing or folding up.



### Choosing A Driver

1. Measure the wrist pin diameter. **tech tips** from the techxperts™
2. Select a driver from the chart at right that is .030" to .040" smaller.
3. Measure the thickness of the bushing.
4. Select the driver with a Step size that is 50% to 60% of the bushing thickness.

**EXAMPLE:**

Wrist Pin Dia. 1.185"  
Nearest Driver Dia. 1.158"  
Bushing Thickness .150"  
40% of Thickness 0.090"

Select Bushing Driver TBD-31

If your measurements do not correspond to a driver in the chart, call 1-800-533-8010 to ask about a special order

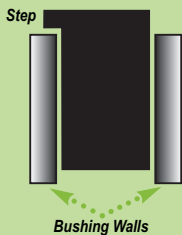

Description	Jobber	Order No.	Incl.
Complete Wrist Pin Bushing Press Kit	\$1,399.99	TB-KIT	▼
Wrist Pin Press Base (select drivers below)	799.99	TB-BASE	x
Press Tube - Small (27x21x120mm)	34.99	TPT-SM	x x
Press Tube - Large (30x31x110mm)	34.99	TPT-LG	x x
Wrist Pin Ring (50x5x20/26mm)	15.99	WPR-001	x x
Wrist Pin Parallels (2) 8x10x50mm	27.99	WPP-2	x x
Extended Mandrel (8 1/2" long)	89.99	TB-MANDREL	x x
<b>Wrist Pin Bushing Drivers sold by dimension, not application</b>			
MM	Nominal	Actual	Step
25	1.000"	0.957"	0.063"
26	1.063"	0.990"	0.058"
27	1.060"	1.032"	0.067"
28	1.100"	1.006"	0.055"
30	1.180"	1.102"	0.075"
31	1.220"	1.158"	0.090"
31	1.220"	1.198"	0.067"
32	1.260"	1.222"	0.078"
33	1.300"	1.268"	0.068"
34	1.340"	1.304"	0.073"
36	1.420"	1.377"	0.075"
38	1.500"	1.458"	0.076"
40	1.570"	1.554"	0.068"
42	1.650"	1.614"	0.097"
45	1.770"	1.742"	0.089"
46	1.810"	1.772"	0.108"
50	1.970"	1.940"	0.083"
52	2.050"	2.012"	0.114"
54	2.130"	2.099"	0.081"
Press Fit Lube (6 oz. Aerosol can)	11.99	PFL-200*	

\*Hazardous Goods Fees Apply When Shipped Air

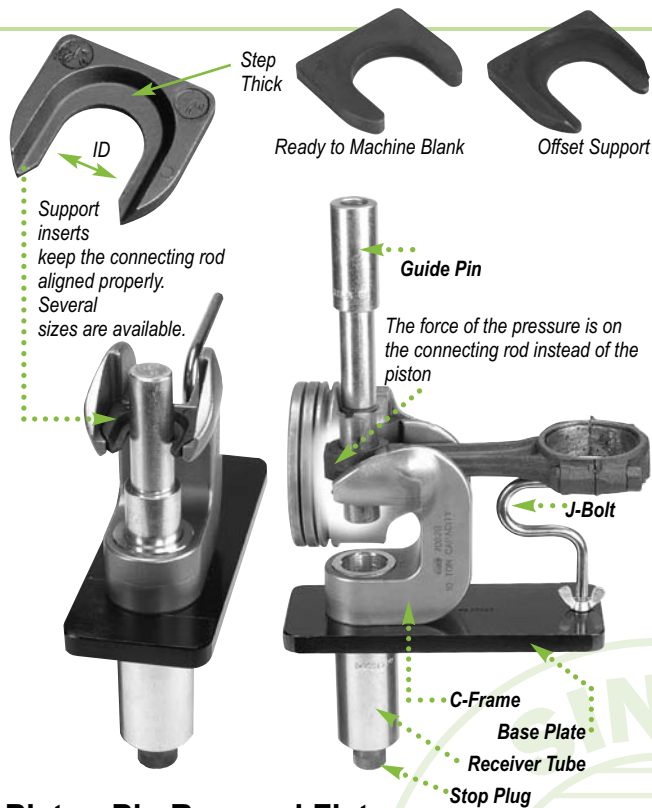

## Piston Pin Removal Fixture

- Use to remove or install interference fit piston pins
- Force of removal is against the piston pin and connection rod – no pressure is exerted on the piston itself
- Tooled to fit most popular engines with pin diameters of 0.859" through 1.087"
- Replacement Support Inserts & Guide Pins sold separately



For Small Block Chevy use Support Insert #1 or #6, for Big Block Chevy, use Support Insert #5, Support #2 is a blank, ready to be machined to your exact specifications.

Description	ID	Thick	Jobber	Order No.	Incl.
<b>Complete Kit</b>			\$999.99	<b>PPE-7082</b>	▼
<b>Replacement C-Frame</b>			319.99	<b>PPE-302186</b>	x
<b>Replacement Support Inserts</b>	#1	0.945" .100"	43.99	<b>PPE-39889</b>	x
	#2	1.110" .275"	43.99	<b>PPE-39890</b>	x
	#3	1.000" .182"	43.99	<b>PPE-39888</b>	x
	#4	1.110" .182"	43.99	<b>PPE-39886</b>	x
	#5	1.000" .100"	43.99	<b>PPE-39887</b>	x
	#6	0.945" .100"	43.99	<b>PPE-39822</b>	x
<b>Replacement Guide Pins</b>	0.859"		\$29.99	<b>PPE-17940</b>	x
	0.897"		29.99	<b>PPE-17936</b>	x
	0.926"		29.99	<b>PPE-17937</b>	x
	0.970"		29.99	<b>PPE-17938</b>	x
	0.992"		29.99	<b>PPE-17939</b>	x
	1.032"		29.99	<b>PPE-17941</b>	x
	1.055"		29.99	<b>PPE-17942</b>	x
	1.087"		29.99	<b>PPE-18729</b>	x
<b>Replacement Parts</b>					
"J" Bolt (Rear Support)			\$25.99	<b>PPE-302224</b>	x
Wing Nut			1.29	<b>PPE-10588</b>	x
1 1/8" / 30.2mm Stop Plug			39.99	<b>PPE-17830D</b>	x
Base Plate			79.99	<b>PPE-17929</b>	x
Receiving Tube			49.99	<b>PPE-17931B</b>	x
Body Guide			41.99	<b>PPE-17932B</b>	x
5/2" / 139.7mm Spring			7.79	<b>PPE-17934</b>	x
Drift Pin Driver			24.99	<b>PPE-17935</b>	x
1 1/8" / 41.3mm External Spiral Lock			10.99	<b>PPE-17945</b>	x

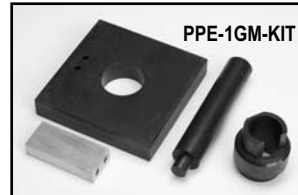
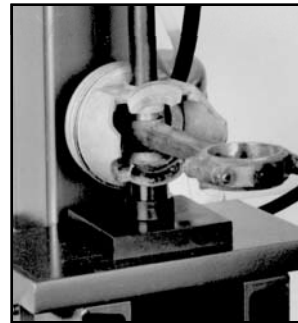

## Universal Piston Pin Press-Out Tool

- Use with a shop press
- Top quality steel tooling
- Standard set handles most applications
- You can modify for individual needs

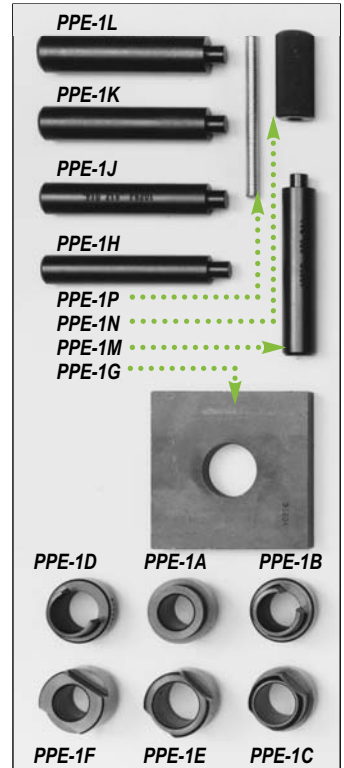

Description	Jobber	Order No.	Incl.	
<b>Piston Pin Extractor Kit</b>	\$249.99	<b>PPE-1</b>	▼	
<b>Rod Support Kit</b>	79.99	<b>PPE-1GM-KIT</b>	▼	
<b>Piston Support Fixtures</b>				
.800" hole	22.99	<b>PPE-1A</b>	x	
.865" hole	22.99	<b>PPE-1F</b>	x	
.950" hole	22.99	<b>PPE-1B</b>	x x	
1.010" hole	22.99	<b>PPE-1C</b>	x	
1.010" hole	22.99	<b>PPE-1D</b>	x	
1.110" hole	22.99	<b>PPE-1E</b>	x	
Fixture Base Block	34.99	<b>PPE-1G</b>	x x	
Pin	.760" dia.	19.99	<b>PPE-1H</b>	x
Pressing	.812" dia.	19.99	<b>PPE-1J</b>	x
Drifts	.875" dia.	19.99	<b>PPE-1K</b>	x x
	1.000" dia.	19.99	<b>PPE-1L</b>	x
Tapped Handle	17.99	<b>PPE-1M</b>	x	
Threaded Rod	8.99	<b>PPE-1N</b>	x	
Threaded Adaptor	15.99	<b>PPE-1P</b>	x	
Rod Support	18.79	<b>PPE-1GM</b>	x	

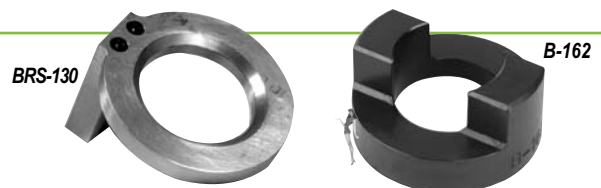

## GOODSON Rod Support for Sunnen® Pin Press Tooling

- Remove late model connecting rods from tapered boss pistons
- Aluminum construction prevents connecting rod damage • Fits Sunnen® tooling

Description	Jobber	Order No.
GOODSON Rod Support	\$62.29	<b>BRS-130</b>
Sunnen® Reducing Ring	46.79	<b>B-162</b>

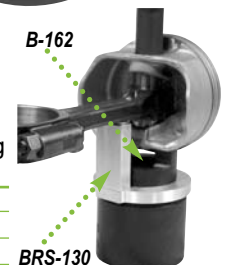

CYLINDER HEAD REBUILDING  
CLEANING, ASSEMBLY & SAFETY  
SHORT BLOCK REBUILDING  
CRANKSHAFT/ FLYWHEEL GRINDING  
MISCELLANEOUS TOOLS & SUPPLIES  
BRAKE & TIRE CHANGING TOOLS  
MEASURING TOOLS  
V-TWIN & METRIC HARD PARTS



"Our easy-to-use, comprehensive catalog features more than 8,000 tool and supplies. Feel free to call if you're not sure what to order or if you have questions. We'll do everything we can to help you get what you need."

- Diane, Purchasing Department - 1 year of service



CYLINDER HEAD REBUILDING  
CLEANING, ASSEMBLY & SAFETY  
SHORT BLOCK REBUILDING  
CRANKSHAFT/ FLYWHEEL GRINDING  
MISCELLANEOUS TOOLS & SUPPLIES  
BRAKE & TIRE CHANGING TOOLS  
MEASURING TOOLS  
V-TWIN & METRIC HARD PARTS

### Piston Installing Deadblow Hammer

- 1-piece design
- Specially formulated, urethane compound is cut and split resistant
- Convex-faced
- Non-mushrooming material
- Offset head
- Ideal for fast, mar-free piston installation
- Weighs 1.7 lbs./ .77 kg
- Order No. **PK-200** Jobber \$47.29



### tech tips

from the techxperts™

For trouble free installation when installing pistons, use the Band Ring Compressors along with the Dead Blow Piston Installing Hammer above



Kits include Compressing Pliers (GPS-98A)

### Band Ring Compressor Kits

- Install rings safely and easily
- Hardened steel for durability
- Trigger ratchet mechanism for tight compressions

Description	Jobber	Order No.	Incl.
6 Pc. Band Ring Compressor Kit	\$44.99	GPS-98	
9 Pc. Band Ring Compressor Kit	67.99	GPS-99	
Compressing Pliers	22.99	GPS-98A	x x
<b>Bands Range in. mm</b>			
1.875" - 2.125"	47.63-53.98	\$12.99 GPS-98Q	
2.125" - 2.375"	53.98-60.33	12.99 GPS-98R	x
2.375" - 2.625"	60.33-66.68	12.99 GPS-98S	x
2.625" - 2.875"	66.68-73.03	12.99 GPS-98T	x
2.875" - 3.125"	73.03-79.38	12.99 GPS-98B	x x
3.125" - 3.375"	79.38-85.73	12.99 GPS-98C	x x
3.375" - 3.625"	85.76-92.08	12.99 GPS-98D	x x
3.625" - 3.875"	92.08-98.43	12.99 GPS-98E	x x
3.875" - 4.125"	98.43-104.78	12.99 GPS-98F	x x
4.125" - 4.375"	104.78-111.13	12.99 GPS-98G	x x
4.500" - 4.750"	114.30-120.65	13.99 GPS-98H	
4.750" - 5.000"	120.65-127.00	13.99 GPS-98I	
5.000" - 5.250"	127.00-133.35	13.99 GPS-98J	
5.250" - 5.500"	133.35-139.70	13.99 GPS-98N	
5.500" - 5.750"	139.70-146.05	13.99 GPS-98K	
5.750" - 6.000"	146.05-152.40	13.99 GPS-98M	
6.000" - 6.250"	152.40-158.75	12.99 GPS-98L	
6.250" - 6.500"	158.75-165.10	12.99 GPS-98V	

### Gas Porting Tools for High Performance

- Virtually eliminate side ring clearance by drilling gas ports in your piston ring lands
- These tiny ports apply compression pressure directly to the back of the ring, pushing it against the cylinder wall with greater force while minimizing compression leakage
- Gas ports work best with piston-compression heights of 1.2" or less on engines running at high rpm (7,000 or higher)
- These simple Tool Kits take all of the guess-work out of gas porting and include everything you'll need to get started
- The complete kit includes: Drill Fixture, Depth Bushing and one Drill Bit

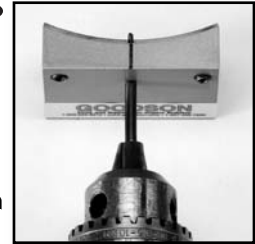

**US Patent No. US D617,664 S**

Description	Size	Jobber	Order No.
Gas Porting Tool Kits	.043"	\$99.99	GPT-043
	.062" and 1.5mm	99.99	GPT-062
	.078"	99.99	GPT-078
Replacement Drill Bits (5 pack)	.040" for GPT-043	7.99	GPT-040-DB
	.062" for GPT-062/GPT-078	7.99	GPT-062-DB

Buy all 3 kits, save 10% off jobber!

### Minnesota Fast Freeze

- Instantly chills seats and guides to -50°F / -45.5°C
- Creates interference fit with heated aluminum heads
- Finish seat and guide work faster than ever • Aerosol\*
- Use on tight bushings, pins, shafts, etc.
- Order No. **MFF-8** Jobber \$29.99



Buy 6 or more and save 10% off jobber

\*Hazardous Goods Fees Apply When Shipped Air

### Press Fit Lubricants

- A light coat eases press fit
- Ideal for valve guides, piston pins, cylinder sleeves, etc.
- Eliminates the scoring, gouging and galling of parts during press fitting



Description	Jobber	Order No.
Goodson Aerosol 6 oz. (170g)	\$11.99	PFL-200*
Sunnen® Aerosol 4.8 oz. (136g)	17.99	B-200*
Sunnen® Brush Applicator 200 mL (not shown)	25.99	B-200L

\*Hazardous Goods Fees Apply When Shipped Air

Buy 12 or more PFL-200 and SAVE 10% off jobber



**American Made**

## Powered Ring Filers

- No more tedious filing and checking and filing and checking to get desired end gap; set it once and cut multiple rings
- Easy to read integral dial indicator and positive ring stop make repeatable precision quick and easy
- Fits 2½"-5"/63.5-127mm diameter rings
- Adjustable guide holds rings square to the cutting wheel
- Table pivots past cutting wheel
- No open ways to gather grinding dust that causes premature wear
- Handy knurled in-feed adjustment knob
- High torque motor

Diamond Dresser is securely held in place by the ring clamping pin



Lighted Rocker Switch



Description	Jobber	Order No.
Powered Ring Filer with Deburring Wheel 110V / 60 cycle	\$849.99	PRF-812DW
Powered Ring Filer with Deburring Wheel 220V / 50 cycle	879.99	PRF-822DW
Replacement Deburring Wheel	39.99	PRF-DW
2½" Replacement Grinding Wheel (60 grit) for pre-2008 models	8.79	PRF-1001
3" Replacement Grinding Wheel (60 grit)	8.79	PRF-1002
Replacement Diamond Dresser	32.99	PRF-812D

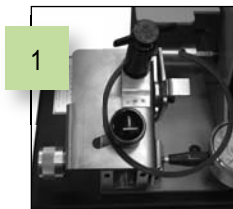

1 Stainless Steel Table

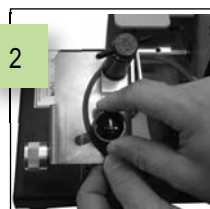

2 Eccentric adjusts quickly and easily

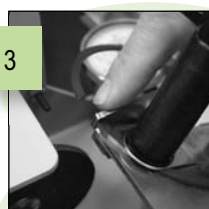

3 Positive ring stop

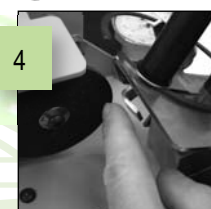

4 Table pivots past grinding wheel

Built-in deburring wheel eliminates the need to hand hone or deburr rings after filing

## Manual Ring Grinder

- Produce end gap rings squarely
- Heavy duty aluminum casting
- Precisely machined for long life
- Silicon-carbide wheel holds shape and produces clean precise cuts
- Includes 1 grinding wheel (replacements available)
- Wheel measures 2½" OD x ¾" ID x ⅛" thick

Description	Jobber	Order No.
Piston Ring Grinder	\$99.99	PRF-250
Replacement Wheel	15.99	PRF-250W

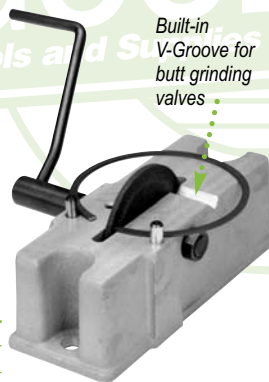

Built-in V-Groove for butt grinding valves

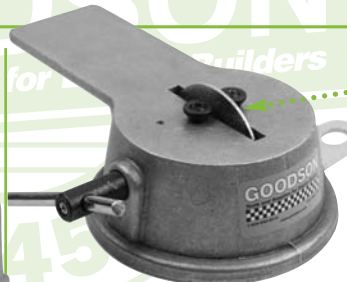

## Manual Ring Grinder

- Universal design lets you grind almost any make, type or size of piston ring
- Includes 1 diamond abrasive wheel

Description	Jobber	Order No.
Universal Piston Ring Filer	\$68.99	PRF-500
Replacement Diamond Abrasive Wheel	44.99	PRF-870-DW

## Fine Abrasive Stick

- Radiused for easier ring deburring after end gapping
- 4" L x ½" radius (101.6mm x 12.7mm)
- Works on all types of rings
- Works on ring ID radii
- Order No. **RS-103**
- Jobber \$27.29



## tech tips

from the techxperts™  
Fine Abrasive Sticks work great for deburring the ends of piston rings after filing, or any part that needs deburring. For a finer finish, soak the abrasive stick in Lapping Oil (LP-LO-4).



## Piston Ring Expander

- Remove & install most rings
- Tapered jaws
- ⅜" to ¼" 1.2mm to 6.35mm ring width
- Order No. **PRE-500**
- Jobber \$13.99

CYLINDER HEAD REBUILDING  
CLEANING, ASSEMBLY & SAFETY  
SHORT BLOCK REBUILDING  
CRANKSHAFT/ FLYWHEEL GRINDING  
MISCELLANEOUS TOOLS & SUPPLIES  
BRAKE & TIRE CHANGING TOOLS  
MEASURING TOOLS  
V-TWIN & METRIC HARD PARTS

# From our customers:



"All of the business I have done with Goodson has been excellent. My sales rep is very helpful, polite and courteous. My rating of her and your tech staff on a scale of 1 to 10 is a 12! Keep up the good work."

— Richard Stokes, Carquest, Winchester, Virginia, Goodson customer since 1990

## Goodson exclusive

Vented top for better performance



### 220V, Single-Phase Electric Rod Heater

- Double wall insulated heating chambers are covered with a safety screen to keep out foreign objects (like fingers)
- Rod supports adjust for height and distance, allowing you to properly support most automotive connecting rods
- Each element operates on a separate thermostat giving you greater control and the ability to work more efficiently
- High intensity LED lamps indicate that the elements have power and may be hot
- Toggle switches are protected by flip-up shields to prevent accidental activation
- Heating chamber opening measure 2 1/2" to fit standard eyes
- Powder coated, heavy-gauge steel housing for long life
- Non-slip rubber feet provide stability
- Includes a digital timer and 450° temperature crayon

CYLINDER HEAD REBUILDING  
CLEANING, ASSEMBLY & SAFETY  
SHORT BLOCK REBUILDING  
CRANKSHAFT/ FLYWHEEL GRINDING  
MISCELLANEOUS TOOLS & SUPPLIES  
BRAKE & TIRE CHANGING TOOLS  
MEASURING TOOLS  
V-TWIN & METRIC HARD PARTS



ERH-TIMER



Use with our Piston Pin Installing Fixture (PIF-25) sold separately (see page 89 for a complete description).

### American Made



WorldwideShipping

Description	Jobber	Order No.
220V, 50/60 Hz Single Phase Electric Rod Heater	\$1,149.99	ERH-2220
Digital Read-Out Timer (battery included)	20.99	ERH-TIMER
Replacement Toggle Switch (ea.)	19.99	ERH-SWITCH
Replacement Toggle Switch Guard (ea.)	47.99	ERH-TSG
Replacement Thermostat (ea.)	99.99	ERH-THERM
Replacement Coil (ea.)	89.99	ERH-COIL
Replacement LED Light Assembly (ea.)	49.99	ERH-LED
Replacement Bezel Knob (ea.)	16.99	ERH-KNOB
Replacement Thumbscrew (ea.)	8.99	ERH-TST
450° Melting Point Temperature Indicator Crayon	17.99	TIC-450
Piston Pin Installation Fixture	69.99	PIF-25

Assemble  
8 rods & pistons  
in as little as  
5 minutes

### Gas-Fired Rod Heater

- Needs no warm-up time – you can start assembling rods and pistons almost immediately
- Heats piston pin ends so fast that the rest of the rod stays cool
- Minimal cool down time after assembly
- Ceramic lined enclosure contains flame, keeping hands safe
- One knob controls the pilot and gas flow, another sets air flow for ideal combustion
- Burner lights easily with a striker (not included)
- No heat coils to burn out or circuitry to fail
- Includes one 600°F Temperature Crayon (see right)
- Propane model includes gas regulator and hose assembly
- Natural Gas model hooks up to your natural gas service



### American Made



WorldwideShipping

Description	Jobber	Order No.
Rod Heater for Propane	\$799.99	RH-50
Rod Heater for Natural Gas	799.99	RH-50N
600°F Temperature Crayon	16.99	TIC-600



Buy 3,  
get 10%  
off  
jobber

### Temperature Indicating Crayons

- Mark the workpiece before heating
- Melts when temperature is reached
- 3 melting points to choose from

Melting Point	Jobber	Order No.
450°F/232.22°C	\$17.99	TIC-450
500°F/260.00°C	17.99	TIC-500
600°F/315.56°C	17.99	TIC-600

**Works great with Rod Heaters on previous page!**

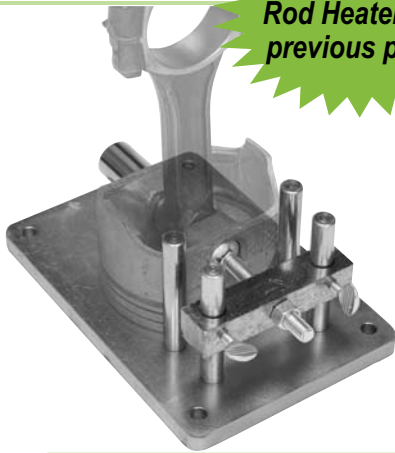

### Piston Pin Installing Fixture

- Base is pre-drilled to mount to a workbench
- Adjustable stops prevent over-centering rods
- Adjust the stop once and you're ready to assemble a full set of rods
- Order No. **PIF-25** Jobber \$69.99



### Rod Bolt Boots

- Save crank journals from rod bolt damage
- Don't risk your reputation for quality
- Plastic boots protect crank journals & rod bolts during piston installation
- Reusable
- Set of 16
- Order No. **RBP-16** Jobber \$7.99

### Rod Clamping Vise

- Align rods and caps perfectly
- Won't damage connecting rods like an ordinary vise
- Clamp rods firmly to align parting faces while torquing rod bolts
- Clamp in a vise or bolt to a workbench
- Order No. **RCV-20** Jobber \$137.99



### Heavy-Duty Rod Bolt Installing Block

- Mount universal block in a vise to support rod while installing bolts
- Hardened aluminum won't slip
- If the top wears, you can restore it with a file or belt grinder
- Ream holes larger to accommodate oversize bolts
- Order No. **RB-50** Jobber \$43.79

Connecting Rod not included



## The best engine pre-lube tank in the industry!

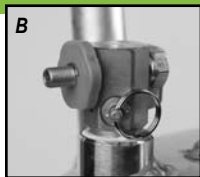

### 12 Quart Engine Pre-Lube Tank

- 12 quart capacity is 2½ times larger than most pre-lube tanks
- Corrosion-resistant aluminum tank eliminates contamination from rust
- Pressure gauge (A) allows positive control of tank pressure
- Pop-off pressure release valve (B) eliminates the risk of over pressurizing the tank
- Brass and Dirlin Teflon® ball valve (C)
- Large 1¼" diameter fill hole lets you pour right from the oil bottle - no funnel required
- 8' long, ¼" fill hose gives you enough length to work easily
- Includes 2 standard fittings AND 1 fitting for the LS engine
- Optional Wall-Hanger includes a storage bin, decimal equivalency chart, towel holder and 1 roll of heavy duty blue shop towels

Description	Jobber	Order No.	Incl.
Pre-Lube Tank Kit	\$329.99	EPL-120KIT	▼
Pre-Lube Tank	279.99	EPL-120	x
Optional Wall-Hanger	74.99	EPL-WH	x
Replacement 8' Hose	39.99	EPL-HOSE	
LS1 Fitting	29.99	EPL-LS1	
¼" Replacement Fitting	3.99	EPL-14	
½" Replacement Fitting	3.99	EPL-18	
Replacement Gauge	12.99	EPL-CG	
Replacement Cap Gasket	12.99	EPL-G	

**American Made**

8' long ¼" hose gives you lots of length to work with

Instructions are printed right on the label for easy reference

Engine Pre-Lube Tank Wall Hanger  
Order No. **EPL-WH**  
Jobber \$74.99



23 3/4"

9" dia.

Blue Shop Towels Included

CYLINDER HEAD REBUILDING  
CLEANING, ASSEMBLY & SAFETY  
SHORT BLOCK REBUILDING  
CRANKSHAFT/ FLYWHEEL GRINDING  
MISCELLANEOUS TOOLS & SUPPLIES  
BRAKE & TIRE CHANGING TOOLS  
MEASURING TOOLS  
V-TWIN & METRIC HARD PARTS



"Technology has merely provided us with more efficient ways to give you, our customers, the quality of service you deserve! Our goal is to make ordering shop supplies faster & easier for you, whether you order by phone or through our website."

- Cheryl, Goodson Computer Systems Analyst - 20 years of service

CYLINDER HEAD REBUILDING  
CLEANING, ASSEMBLY & SAFETY  
SHORT BLOCK REBUILDING  
CRANKSHAFT/ FLYWHEEL GRINDING  
MISCELLANEOUS TOOLS & SUPPLIES  
BRAKE & TIRE CHANGING TOOLS  
MEASURING TOOLS  
V-TWIN & METRIC HARD PARTS

### Oil Gallery Plug Installer / Staker

- Set depth and lock plug in a single step
- Arbor nose aligns cup plug, then follows with two 180° staker lugs to set depth and lock oil gallery plug securely in place
- Order No. **ST-SB**  
Jobber \$39.99



**new**

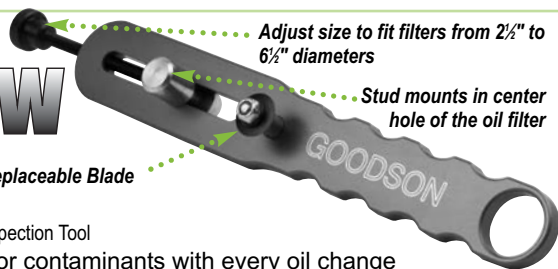

Includes 1 Replaceable Blade

- Oil Filter Inspection Tool
- Check for contaminants with every oil change
- Cut open the filter canister for inspection
- Fits 2½" to 6½" diameter filters
- Includes a single blade

Description	Jobber	Order No.
Oil Filter Inspection Tool	\$54.99	FIT-1-G
Replacement Cutter Blade	11.99	FIT-W

### Oil Gallery Plugs

- Replace lost or damaged originals
- ¼"/6.35mm plugs
- For use at the rear of Small Block Chevy oil galleries or other engines with similar size plugs
- 25 per box
- Order No. **OP-250**  
Jobber \$7.99

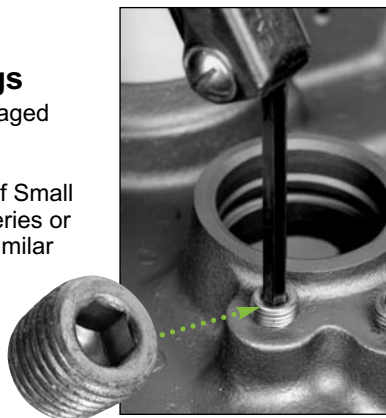

### Oil Pump Pickup Tube Driver

- For all GM pumps
- Replace pickup tubes easily with a light mallet
- Driver grips the pickup tube flare
- Gives control for fast alignment and installation



Application	Tube OD	Jobber	Order No.
Small Block	5/8"/15.9mm	\$29.99	TI-25
Big Block	3/4"/19.1mm	29.99	TI-30

### Oil Gallery Brushes

Steel Wire	Size	Length	Jobber	Order No.	Incl.
<b>3-pc. Kit</b>			\$16.99	<b>OGB-SK</b>	▼
	1/4" x 3"	24"	7.49	<b>OGB-1</b>	x
	3/8" x 3"	24"	8.49	<b>OGB-2</b>	x
	5/8" x 3"	24"	9.49	<b>OGB-3</b>	x
<b>Nylon Bristle</b>			\$27.99	<b>OGB-KIT</b>	▼
<b>5-pc. Kit</b>					
	3/8" x 3"	34"	6.49	<b>OGB-38</b>	x
	1/2" x 2 1/2"	34"	6.79	<b>OGB-42</b>	x
	5/8" x 3"	34"	6.79	<b>OGB-5</b>	x
	3/4" x 3"	34"	7.49	<b>OGB-7</b>	x
	3/4" x 3"	40"	8.99	<b>OGB-8</b>	x

Buy 5 or more brushes (any combination), take 10% off jobber! Buy 15 or more brushes (any combination), take 15% off jobber! More brushes on page 62.

### Oil Gallery Plug Removers

- Power plugs out with an impact wrench
- Threaded plug inside prevents bit from backing into the holder
- 1/2"/12.7mm drive – fits impact wrenches
- Hardened tool-steel holder with lifetime breakage guarantee
- Tool-steel bit can be reground or replaced
- Set screw holds bit firmly in place

Description	Size	Jobber	Order No.	Incl.
<b>Plug Remover Kit</b>	in	\$144.99	<b>PPS-KIT</b>	▼
<b>Replacement Tool</b>	3/16"	39.99	<b>PPS-187</b>	x
	1/4"	39.99	<b>PPS-250</b>	x
	9/32"	41.99	<b>PPS-281*</b>	x
	5/16"	39.99	<b>PPS-312</b>	x
	3/8"	39.99	<b>PPS-375</b>	x
<b>Replacement Bits</b>	3/16"	11.49	<b>PPS-187B</b>	
	1/4"	11.49	<b>PPS-250B</b>	
	5/16"	11.49	<b>PPS-312B</b>	
	3/8"	11.49	<b>PPS-375B</b>	

NOTE: \*No bit is needed for PPS-281 (square socket).

### Oil Gallery Wax

- Preheat the part to be removed, apply wax to its base, allow to cool and remove the part
- Choose between wax sticks and blocks of beeswax



Description	Jobber	Order No.
Oil Gallery Wax - 6" sticks (10 pk.)	\$17.99	<b>OGW-1</b>
Beeswax Stick - 1" 3/4"x3"/25.4x19.1x76.2mm	4.99	<b>BWS-1</b>



### Lifter Bore Burnishing Tool

- Eliminates burrs caused by shot blasting
- Drive the burnishing tool into the bore with a soft hammer, then slide-hammer it back out
- 60Rc burnishing balls deburr faster
- Won't oversize the bore

Description	Jobber	Order No.
<b>Kit:</b>	\$139.99	LBB-1500
Slide Shaft	12.49	GAO-1 x
Slide Hammer	21.99	GAO-2 x
Jam Nut	7.99	LBB-NUT x
<b>Lifter Bore Burnishing Balls</b>		
<b>Complete Set</b>	\$119.99	LBB-3SET
GM .845" dia.	39.99	LBB-GM1 x x
Ford .876" dia.	39.99	LBB-FO1 x x
Chrysler .906" dia.	39.99	LBB-CR1 x x



### Manual Frost Plug Tool

- Minimizes the chance of frost plug distortion and leakage
- Two handle lengths – use the short handle for rebuild jobs, and the long handle for engines still in the vehicle
- Kit includes five sizes of installing plugs, ring nut and two steel handles
- Replacement parts available – call for details
- Order No. **FP-20** Jobber \$69.99

### Rod Honing Oil

- Includes additives for high pressure cutting
- Keeps stones clean and free-cutting during rod reconditioning, pin fitting and other honing applications
- Will mix with other honing oils (including Sunnen®)



Size	Jobber	Order No.
1 gal./3.78L	\$ 34.99	RHO-10
5 gal./18.9L	174.99	RHO-50

### Clear Honing Oil

- Helps keep stones clean and free-cutting
- Ideal for portable hones and all makes of automotive honing machines
- Mixes easily with other brands, including Sunnen®
- Not water soluble

Size	Jobber	Order No.
1 gal./3.78L	\$ 26.99	HO-10
5 gal./18.9L	114.99	HO-50



### Sunnen® Lifter Bore Hones

- Restore bore size and finish after shot blasting
- Install oversize lifters for high-performance
- Stones work in cast iron bores or ones sleeved with brass or steel
- Wide stones contact a large area giving better stability for hand honing
- Cross oil ports without catching
- Wedge-type adjustment is a simple, positive way to expand or contract the stone to the precise size
- Use a 3/8"/9.5mm or 1/2"/12.7mm hand-held electric or air drill at approx. 200 RPM
- Use with honing oil
- **All parts MUST be ordered separately to make a complete unit**

**tech tips**  
from the techxperts™

*NOTE: Wedges may come with a tab that must be removed BEFORE using them with the P-180 Head*

Description	Jobber	Order No
Honall Head	\$314.99	P-180
Adaptor	69.99	PAK20-A
Roughing Stone (280 Grit) 12/box	94.49	Y20-J67
Finishing Stone (400 Grit) 12/box	94.49	Y20-J87
<b>Standard Lifter Bore Tooling (6" Reach)</b>		
Mandrel .838" - .869" Range	\$362.29	AAAY20838BH6LH
.869" - .900" Range	362.29	AAAY20869BH6LH
Wedge	60.79	Y20-W-6LH
Retainer	41.99	LN-3688A-6LH
Truing Sleeve .838" - .869" Range	16.29	S-838
.869" - .900" Range	16.29	S-869
<b>Extended Reach Lifter Bore Tooling (6 3/4" Reach)</b>		
Mandrel .838" - .869" Range	\$362.79	AAAY20838675LH
.869" - .900" Range	362.79	AAAY20869675LH
Wedge	60.79	Y20-W-675LH
Retainer	41.99	LN-3688A675LH
Truing Sleeve .838" - .869" Range	16.29	S-838
.869" - .900" Range	16.29	S-869

### Severe Duty Valve Refacer Oil

- Mineral Based
- Formulated for titanium, Inconel®, stainless steel and stellite
- Includes additives to improve cutting performance under high pressure
- Ideal for lifter bore honing

Size	Jobber	Order No.
1 Gal.	\$ 34.99	VGO-SD10
5 Gal.	174.99	VGO-SD50



CYLINDER HEAD REBUILDING ASSEMBLY & SAFETY CLEANING SHORT BLOCK REBUILDING CRANKSHAFT/FLYWHEEL GRINDING TOOLS & SUPPLIES MISCELLANEOUS BRAKE & TIRE CHANGING TOOLS MEASURING TOOLS V-TWIN & METRIC HARD PARTS



"The Mach-B division of Goodson offers many services such as ANGI compliant speed testing, balance testing, grinding wheel shaping, resizing and more. Find out more at Mach-B.com."

- Jeff, Mach-B Abrasive Shaping Resizing Specialist - 2 years of service

CYLINDER HEAD REBUILDING  
CLEANING, ASSEMBLY & SAFETY  
SHORT BLOCK REBUILDING  
CRANKSHAFT/ FLYWHEEL GRINDING  
MISCELLANEOUS TOOLS & SUPPLIES  
BRAKE & TIRE CHANGING TOOLS  
MEASURING TOOLS  
V-TWIN & METRIC HARD PARTS

Brushed Aluminum Storage Rack Included with kit purchase



## Universal Cam Bearing Tool

- Remove and install hundreds of sizes of cam bearings with just four mandrels!
- Expanding Mandrels cover a 1.370"-2.250" range
- Adjusts to undersize bearings so you can remove and install them from virtually any block
- Interchangeable with Dura-Bond

Description	Jobber	Order No.	Incl.
<b>Universal Cam Bearing Tool</b>	\$469.99	CBT-300	▼
<b>A-Replacement Segments with Sleeves</b>			
Max Dia. 1.370"	\$ 55.79	CBT-5M	x
1.682"	55.79	CBT-6M	x
1.875"	60.79	CBT-7M	x
2.250"	66.99	CBT-8M	x
<b>B-Replacement Backing Plates</b>			
Max Dia. 1.370"	\$ 14.79	CBT-5W	x
1.682"	16.79	CBT-6W	x
1.875"	17.79	CBT-7W	x
2.250"	18.99	CBT-8W	x
<b>C-Replacement Neoprene Sleeves</b>			
Max Dia. 1.370"	\$ 7.49	CBT-5NS	x
1.682"	8.99	CBT-6NS	x
1.875"	8.99	CBT-7NS	x
2.250"	11.29	CBT-8NS	x
<b>Drivers</b>			
Length 5"	\$ 52.49	CBT-1B	x
24"	104.99	CBT-2B	
36"	136.49	CBT-3B	x
48"	146.99	CBT-4B	
<b>Miscellaneous Replacement Parts</b>			
D-1 $\frac{1}{8}$ " Expander with stud	\$ 56.79	CBT-3E	x
D-1 $\frac{1}{8}$ " Expander with stud	53.79	CBT-4E	x
$\frac{1}{2}$ "x13 Stud	11.79	CBT-1S	x
Guide Cone	31.49	CBT-1C	x
Threaded Impact Cap (New Style)	45.49	CBT-300-CAP	x

## Chevy Starter Drill Jig

- Drill & tap guide for perfect alignment
- For blocks missing inner mounting bolt hole necessary for use with mini starters
- Also use as a drilling and tapping jig for removing broken starter bolts
- Allows easy repair of the fastener holes
- Use with standard drills and taps (not included)
- 3 heat-treated tool/steel machining plates
- Order No. **SDJ-1** Jobber \$114.99



## Degree Wheel

- Check cam timing, duration and overlap
- Degree wheel measures 11"/279.4mm dia. with 1 $\frac{1}{8}$ "/47.6mm hole • Small ID Adaptor Kit mounts it to cranks using  $\frac{7}{16}$ "- $\frac{3}{4}$ "/11.1-19.1mm fasteners or use the turning tool for that engine to mount the wheel
- Use with  $\frac{1}{2}$ "/12.7mm drive ratchet

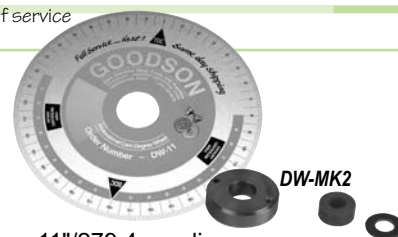

Wheel / Adaptors	Jobber	Order No.	Incl
Automotive Degreasing Kit	\$59.99	DW-KIT-2	▼
Degree Wheel	29.99	DW-11	x
Small ID Adaptor Kit	15.99	DW-MK2	x

## Bearing Scraper

- Eliminate bearing high spots after installation to assure correct oil clearance
- Solid, wire wound, wood handle for strength and resistance to splitting
- 4"/101.6mm blade with 3 cutting edges
- Order No. **BS-30** Jobber \$22.99



## Cam Bolt Locking Plate

- Keep timing bolts from backing out
- Use to secure timing sprockets
- Ideal for small block, high-performance Chevys
- Order No. **CBL-9** Jobber \$3.99



## 6 Piece Small Block Chevy Deck Plug Kit

- $\frac{3}{4}$ " NPT cast iron plugs
- Help stabilize the critical deck area on Small Block Chevys
- Eliminates deck walk for better stability, ensuring a better ring seal
- Order No. **DPK-SB** Jobber \$24.29



## Lifting Sling

- Lift up to 1800 lbs./816.5 kg safely and easily
- 1" x 36"/25.4x914.4mm looped sling
- Secure the sling to the workpiece and move it with your overhead hoist
- Durable, nylon webbing
- Not for use with caustics or temperatures exceeding 190°F / 87.8°C
- Order No. **LS-3** Jobber \$10.99



## Whether you're regrinding cores for stock applications or custom grinding for diesel and high performance, you can count on Goodson Cam Grinding Wheels to deliver an excellent finish

Goodson abrasives are second to none. We work with our manufacturer to get you the most ideal grain that's bonded to be free-cutting, yet still shed before loading up. Our Premium wheels are ideal for steel high performance camshafts of 55 to 65 Rc and for Stellite overlays. Goodson makes all Camshaft Grinding Wheels to your specifications in-house for fast turn-around and delivery. Choose from the sizes below or custom order your cam wheel today!



Standard Cam Grinding Wheels - 100 grit					
Diameter	Width	Arbor	Jobber	Order No.	
Fits Storm Vulcan 75, 75D, 1165, 1165A					
18"	7/8"	19mm	3" 76mm	\$172.99	GCC 18 x 0.750 x 3
457mm	7/8"	22mm	3" 76mm	172.99	GCC 18 x 0.875 x 3
	1"	25mm	3" 76mm	172.99	GCC 18 x 1.000 x 3
	1 1/16"	27mm	3" 76mm	207.99	GCC 18 x 1.062 x 3
	1 1/8"	29mm	3" 76mm	207.99	GCC 18 x 1.125 x 3
20"	1 1/4"	32mm	3" 76mm	207.99	GCC 18 x 1.250 x 3
	7/8"	22mm	3" 76mm	199.99	GCC 20 x 0.875 x 3
	1"	25mm	3" 76mm	199.99	GCC 20 x 1.000 x 3
	1 1/16"	29mm	3" 76mm	239.99	GCC 20 x 1.125 x 3
508mm	1 1/4"	32mm	3" 76mm	239.99	GCC 20 x 1.250 x 3
	1 1/2"	38mm	3" 76mm	294.99	GCC 20 x 1.500 x 3

Due to the manufacturing process, actual colors may vary

Standard Cam Grinding Wheels - 100 grit					
Diameter	Width	Arbor	Jobber	Order No.	
Fits WVN 253, 254, 255 Peterson/Berco RAC-1500, RAC-2130					
18"	7/8"	19mm	6" 152mm	\$153.99	GCC 18 x 0.750 x 6
457mm	7/8"	22mm	6" 152mm	153.99	GCC 18 x 0.875 x 6
	1"	25mm	6" 152mm	183.99	GCC 18 x 1.000 x 6
	1 1/16"	29mm	6" 152mm	299.99	GCC 18 x 1.125 x 6
	1 1/4"	32mm	6" 152mm	299.99	GCC 18 x 1.250 x 6
20"	7/8"	22mm	6" 152mm	199.99	GCC 20 x 0.875 x 6

Green Silicon-Carbide Cam Grinding Wheels - 70 grit					
Diameter	Width	Arbor	Jobber	Order No.	
Fits Storm Vulcan 75, 75D, 1165, 1165A					
18"	7/8"	22mm	3" 76mm	\$369.99	GCW-181403
20"	7/8"	22mm	3" 76mm	369.99	GCW-201403
Fits WVN 253, 254, 255 Peterson/Berco RAC-1500, RAC-2130					
18"	7/8"	22mm	6" 152mm	\$329.99	GCW-181406
20"	7/8"	22mm	6" 152mm	369.99	GCW-201406

### Torque-Angle Indicator

- When torque is given as degrees of turn past a certain ft./lb., use this gauge to show degrees
- 1/2" square drive
- Hold metal base with one hand
- Plastic dial turns as you tighten
- Fits between a socket-driven extension and the socket
- Order No. **TQR-4554**  
Jobber \$19.99



### Hardness Tester

- Calculate Rockwell Hardness quickly and accurately
- Features a steel ball of precise weight and shape which is dropped from an exact height to yield an accurate Rc reading
- Check overheated or repaired crankshaft journals to confirm correct hardness
- Includes case & instructions
- Also use on flywheels
- Weighs just 4 oz.
- 9 1/4" long
- Order No. **HT-45RC** Jobber \$199.99

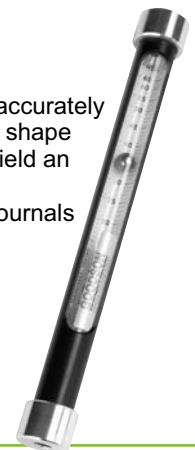

### Bore Washing Brushes

- Clean tunnel housing bores and full-annular grooved area
- Heavy, hand-driven shank

Dia.	Length	Jobber	Order No.
2"	36"	\$18.99	CBB-200
2 1/4"	36"	19.99	CBB-225
2 1/2"	36"	20.99	CBB-250
2 3/4"	18 1/2"	23.29	CWB-27W
3 1/2"	18 1/2"	23.29	CWB-35
4"	18 1/2"	23.29	CWB-40
4 1/2"	18 1/2"	24.29	CWB-45
5"	18 1/2"	25.29	CWB-50



Buy 5 or more brushes (any combination), take 10% off jobber! Buy 15 or more brushes (any combination), take 15% off jobber! More brushes on page 62.

### Cam Bearing Flex-Hones®

- Silicon-Carbide globules laminated to high density nylon
- Includes 18" drive rod
- 180 grit

Inch	mm	Jobber	Order No.
1 3/4"	45	\$44.29	CBF-175
2"	51	44.79	CBF-200
2 1/4"	57	46.79	CBF-225
2 1/2"	64	48.79	CBF-250
2 3/4"	70	60.99	CBF-275

Buy 3 or more Flex-Hones® (any combination), SAVE 10% off jobber! More Flex-Hones® on page 72



CYLINDER HEAD REBUILDING  
CLEANING, ASSEMBLY & SAFETY  
SHORT BLOCK REBUILDING  
CRANKSHAFT/ FLYWHEEL GRINDING  
MISCELLANEOUS TOOLS & SUPPLIES  
BRAKE & TIRE CHANGING TOOLS  
MEASURING TOOLS  
V-TWIN & METRIC HARD PARTS

Full Service  
...FAST!!



"We're continually expanding our production department to provide more flexibility in grinding wheel shapes, sizes and profiles. Give us a call when you need something special."  
- Orlo, Goodson Production - 30 years of service

## Goodson crankwheels are made-to-order in-house

Other sources stock finished wheels, which makes it virtually impossible to stock a full size range. If they don't have what you need, they may charge more and delay your order for weeks. That's why Goodson makes every wheel to order. We always have the right wheel because we take a blank, size it, shape it, test it and ship it. Multiple wheel orders generally ship within approximately 72 hours.

For future reference write down your  
**Crank Wheel #**

*Grade x Diameter x Face Width x Arbor Size x Machine x Shape*

### Select the shape

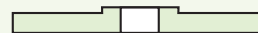

Hub

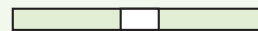

Straight

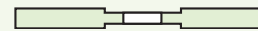

Recessed 2 Sides

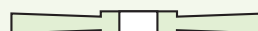

Tapered

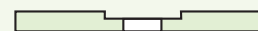

Recessed 1 Side

## Select your wheel grade:

### GCH Superior Grade - 54 grit

Better form holding ability, cuts cooler and needs less dressing. Use on crank journals with Rockwell hardness of 35 Rc or less. Use on crankshafts of cast or forged steel, Nodular iron. Ideal for large radii, thrust and plunge grinding. Great for high-performance.

### GCD Premium Grade - 60 grit

For harder materials. Good form holding ability; cuts cooler and needs less dressing. Grains yield faster, cooler grinding. Use on journals with Rockwell hardness of 35 Rc or more. Ideal for diesel, high-performance, industrial and billet steel.

## Increase coolant flow with Crankwheel Slotting

Slotting facilitates the flow of coolant to the thrust and radius areas of the crank shaft. Don't waste time waiting on other suppliers who outsource their crankwheels for slotting – Goodson has a shop full of equipment, so we can slot wheels in house!

## How to order:

If you have any questions, please call 1-800-533-8010

Grade	Diameter	Face Width	Arbor Size	Machine	Shape
GCH- Superior	Diameters are available from 18" to 36" in most grades	Most sizes from 3/4" to 2 5/8" (custom widths are no extra charge)	Arbor size of your grinder. Any hole 3" to 12"	Identify the make and model of your grinder	We send the standard shape for your grinder unless you specify differently
GCD- Premium					

Enter your information below, then call Goodson at 1-800-533-8010 to order

GRADE X DIAMETER X FACE WIDTH X ARBOR SIZE X MACHINE X SHAPE

Please note, all wheels are delivered .015" oversize to allow for side dressing when mounting



# Crankshaft Grinding Wheels

## Custom Shaping & Sizing

### GCH Superior Grade

Cuts cooler. Needs less dressing. Use on journals with Rockwell hardness of 35 Rc or less. Use on cast or forged steel or nodular iron. Ideal for large radii, thrust and plunge grinding. Great for high-performance.

**Models shown are for reference only. Be sure to specify ID, OD and Shape when ordering.**

### GCD Premium Grade

For harder materials. Cuts cooler and needs less dressing. Grains yield faster. Use on journals with Rockwell hardness of 35 Rc or more. Ideal for diesel, industrial, high-performance and billet steel.

Dia.	GCH (54 grit)		GCD (60 grit)	
	Jobber	Width	Jobber	Width
Fits Storm Vulcan 14, 15				
18"	\$199.99	3/4"-1"		
3" Arbor	249.99	1 1/4"-1 1/4"		
	348.99	1 1/4"-1 1/2"		
	353.99	1 3/4"-1 3/4"		
	358.99	1 3/4"-2"		
Fits Storm Vulcan 15, 15 Special, 1550, 1648				
20"	\$204.99	3/4"-1"		
3" Arbor	252.99	1 1/4"-1 1/4"		
	350.99	1 1/4"-1 1/2"		
	354.99	1 3/4"-1 3/4"		
	359.99	1 3/4"-2"		
Fits Kwik-Way / Lempro TKG Series, 518				
20"	\$214.99	3/4"-1"		
3 3/4" Arbor	254.99	1 1/4"-1 1/4"		
	359.99	1 1/4"-1 1/2"		
	361.99	1 3/4"-1 3/4"		
	365.99	1 3/4"-2"		
Fits Kwik-Way / Lempro 519 & Storm Vulcan 15A (early)				
22"	\$348.99	3/4"-1"		
5" Arbor	351.99	1 1/4"-1 1/4"		
	369.99	1 1/4"-1 1/2"		
	372.99	1 3/4"-1 3/4"		
	379.99	1 3/4"-2"		
Fits Peterson Berco 180				
22"	\$352.99	3/4"-1"	\$423.99	3/4"-1"
8" Arbor	359.99	1 1/4"-1 1/4"	489.99	1 1/4"-1 1/4"
	369.99	1 1/4"-1 1/2"	571.99	1 1/4"-1 1/2"
	391.99	1 3/4"-1 3/4"	589.99	1 3/4"-1 3/4"
	394.99	1 3/4"-2"	599.99	1 3/4"-2"
Fits Storm Vulcan 15A (late), 15A Special; RMC/Robbi REX-1200				
24"	\$398.99	3/4"-1"	\$429.99	3/4"-1"
5" Arbor	424.99	1 1/4"-1 1/4"	499.99	1 1/4"-1 1/4"
	439.99	1 1/4"-1 1/2"	579.99	1 1/4"-1 1/2"
	479.99	1 3/4"-1 3/4"	589.99	1 3/4"-1 3/4"
	499.99	1 3/4"-2"	619.99	1 3/4"-2"
Fits Kwik-Way / Lempro KGA and NKG Series				
24"	\$410.99	3/4"-1"	\$431.99	3/4"-1"
5 1/2" Arbor	550.99	1 1/4"-1 1/4"	503.99	1 1/4"-1 1/4"
	579.99	1 1/4"-1 1/2"	583.99	1 1/4"-1 1/2"
	589.99	1 3/4"-1 3/4"	599.99	1 3/4"-1 3/4"
	629.99	1 3/4"-2"	629.99	1 3/4"-2"
Van Norman 438, 448, 460, 465;				
Winona Van Norman/Zanrosso CG-210 (early); Storm Vulcan Scledum 200				
24"	\$429.99	3/4"-1"	\$435.99	3/4"-1"
8" Arbor	569.99	1 1/4"-1 1/4"	511.99	1 1/4"-1 1/4"
	599.99	1 1/4"-1 1/2"	599.99	1 1/4"-1 1/2"
	624.99	1 3/4"-1 3/4"	619.99	1 3/4"-1 3/4"
	656.99	1 3/4"-2"	639.99	1 3/4"-2"



**Crank Grinding Coolant**

- Semi synthetic
- Non-nitrite
- High-lubricity
- Dilute 20:1

Size	Jobber	Order No.
1 gal. (3.78L)	\$ 33.99	<b>CGC-10</b>
5 gal. (18.93L)	149.99	<b>CGC-50</b>

Prices may vary due to market fluctuations - Call to confirm pricing

Dia.	GCH (54 grit)		GCD (60 grit)	
	Jobber	Width	Jobber	Width
Storm Vulcan 15C				
25"	\$439.99	3/4"-1"	\$499.99	3/4"-1"
5" Arbor	569.99	1 1/4"-1 1/4"	549.99	1 1/4"-1 1/2"
	595.99	1 1/4"-1 1/2"	619.99	1 3/4"-1 3/4"
	629.99	1 3/4"-1 3/4"	649.99	1 3/4"-2"
	659.99	1 3/4"-2"		
AMC K1100; Peterson Berco 180, 225; Scledum 200, 230; Van Norman 438, 448, 460, 465, 475, 476; Winona Van Norman CG-210 (late), CG-840				
26"	\$479.99	3/4"-1"	\$509.99	3/4"-1"
8" Arbor	529.99	1 1/4"-1 1/4"	559.99	1 1/4"-1 1/4"
	599.99	1 1/4"-1 1/2"	589.99	1 1/4"-1 1/2"
	639.99	1 3/4"-1 3/4"	679.99	1 3/4"-1 3/4"
	669.99	1 3/4"-2"	699.99	1 3/4"-2"
804.99	2 1/4"-2 1/4"	709.99	2 1/4"-2 1/4"	
Schou 1500/270, 1600, 260				
27 1/2"	\$529.99	3/4"-1"	\$519.99	3/4"-1"
8 5/8" Arbor	569.99	1 1/4"-1 1/4"	569.99	1 1/4"-1 1/2"
	589.99	1 3/4"-1 3/4"	694.99	1 3/4"-1 3/4"
	679.99	1 3/4"-2"	709.99	1 3/4"-2"
			718.99	2 1/4"-2 1/4"
Peterson Berco 260; SV Scledum 230, 270/280; Zanrosso Mito 250; Van Norman 400, 438, 439, 475, 476, 666; RMC/Robbi REX-1500				
28"	\$531.99	3/4"-1"	\$539.99	3/4"-1"
8" Arbor	571.99	1 1/4"-1 1/2"	579.99	1 1/4"-1 1/2"
	589.99	1 3/4"-1 3/4"	694.99	1 3/4"-1 3/4"
	659.99	1 3/4"-2"	709.99	1 3/4"-2"
			793.99	2 3/8"-2 3/8"
Seest MC62				
30"	\$589.99	3/4"-1"		
6" Arbor	629.99	1 1/4"-1 1/2"		
	649.99	1 3/4"-1 3/4"		
	889.99	1 3/4"-2"		
Zanrosso Mito 280; Storm Vulcan Scledum 270/280;				
RMC / Robbi REX-1800, REX 2200L				
30"	\$599.99	3/4"-1"	\$ 759.99	3/4"-1"
8" Arbor	639.99	1 1/4"-1 1/4"	779.99	1 1/4"-1 1/4"
	659.99	1 1/4"-1 1/2"	799.99	1 1/4"-1 1/2"
	669.99	1 3/4"-1 3/4"	829.99	1 3/4"-1 3/4"
	885.99	1 3/4"-2"	859.99	1 3/4"-2"
		899.99	2 1/4"-2 1/4"	
		999.99	2 3/8"-2 3/8"	
AMC 1400, K1500, K1800; Van Norman 467, 477; Zanrosso				
32"	\$629.99	3/4"-1"	\$ 769.99	3/4"-1"
8" Arbor	649.99	1 1/4"-1 1/4"	789.99	1 1/4"-1 1/2"
	679.99	1 1/4"-1 1/2"	839.99	1 3/4"-1 3/4"
	685.99	1 3/4"-1 3/4"	879.99	1 3/4"-2"
	889.99	1 3/4"-2"	959.99	2 1/4"-2 1/4"
		1019.99	2 3/8"-2 3/8"	
Peterson Berco 280, 300; RMC Robbi REX-1800RM; REX-2200, REX-2200RM, REX-2700RM, REX-3100RM				
32"	\$639.99	3/4"-1"	\$ 789.99	3/4"-1"
12" Arbor	659.99	1 1/4"-1 1/2"	799.99	1 1/4"-1 1/2"
	689.99	1 3/4"-1 3/4"	994.99	1 3/4"-1 3/4"
	899.99	1 3/4"-2"	1,003.99	1 3/4"-2"
			1,011.99	2 1/4"-2 1/4"
		1,029.99	2 3/8"-2 3/8"	
Peterson Berco 300, 350; Storm Vulcan Scledum 250; RMC / Robbi REX-2200M, 2700M, 3100M; Winona Van Norman 111				
36"			\$899.99	3/4"-1 1/2"
12" Arbor			1,042.99	1 3/4"-2"
			1,179.99	2 1/4"-2 1/4"
			1,489.99	2 3/8"-2 3/8"

CYLINDER HEAD REBUILDING  
CLEANING, ASSEMBLY & SAFETY  
SHORT BLOCK REBUILDING  
CRANKSHAFT/FLYWHEEL GRINDING  
MISCELLANEOUS TOOLS & SUPPLIES  
BRAKE & TIRE CHANGING TOOLS  
MEASURING TOOLS  
V-TWIN & METRIC HARD PARTS

"After being in business almost 30 years now, performing Harley-Davidson cylinder head work for most of that, and running the gamut in the V-Twin industry with various valves, guides, and springs, we have come to realize through flow testing, dyno testing, and along with client feedback, that there is really one true source for this. AV&V, through the outstanding customer support from the great folks at Goodson."

- Scott Palmer, Hillside Motorcycle & Machine, Inc., Munnsville, NY, Goodson Customer since 2004

CYLINDER HEAD REBUILDING  
CLEANING, ASSEMBLY & SAFETY  
SHORT BLOCK REBUILDING  
CRANKSHAFT/ FLYWHEEL GRINDING  
MISCELLANEOUS TOOLS & SUPPLIES  
BRAKE & TIRE CHANGING TOOLS  
MEASURING TOOLS  
V-TWIN & METRIC HARD PARTS

## Plastigage

- Accurately measure bearing clearance
- Color coded by size
- Put a piece on rod or main bearing and torque the cap
- Remove and inspect – width of crushed Plastigage shows clearance
- Use at the workbench or in the vehicle
- 10 per pack

Clearance Range	Jobber	Order No.
.001" to .003" / .025 to .076mm	\$21.99	PG-GREEN
.002" to .006" / .051 to .152mm	21.99	PG-RED
.004" to .009" / .102 to .229mm	21.99	PG-BLUE
10pk. Assortment (5 Green, 3 Red, 2 Blue)	21.99	PG-10PK

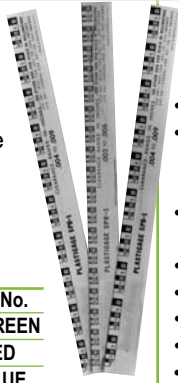

## Hardness Tester

- Calculate Rockwell Hardness quickly and accurately
- Features a steel ball of precise weight and shape which is dropped from an exact height to yield an accurate Rc reading
- Check overheated or repaired crankshaft journals to confirm correct hardness
- Includes case & instructions
- Also use on flywheels
- Weighs just 4 oz.
- 9¼" long
- Order No. **HT-45RC** Jobber \$199.99

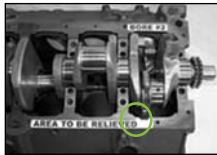

Create a relief in the block for rod #2 at the pan rail area using your normal process.



Place the arbor in main saddles 1 & 2, keeping the flange nearest to the pointer against #2.



Rotate the arbor and adjust the pointer until the tapered end passes freely through the relief with a minimum of clearance.



Lock the pointer in position with the set screw and check the clearance.



Once satisfied, scribe a line on the pointer opposite the set screw.



## Stroker Mimic™

- Lightweight and easy to use
- Eliminates the need to repeatedly install and remove the crankshaft, pistons, the rod assembly and the necessary bearings when clearancing a block for a stroker crank
- Once the Stroker Mimic™ has been set to a particular crank, rod and piston combination, the tool can be marked or measured for future reference

Description	Jobber	Order No.
Stroker Mimic™ Fixture for 350 Blocks	\$167.99	SM-350
Replacement Pointer for SM-350	32.79	SM-351

## Crankshaft Machining V-Blocks

- Use to cross-drill journals, keyway cutting, etc.
- Installs easily on Bridgeport-type machine with standard hold downs or bolts and "T" nuts (not included)
- Accepts diameters from 1" to 3¼"
- ¾" wide • Aluminum and steel construction
- Set up at ± .001" • 1 Pair
- Order No. **CVB-100** Jobber \$299.99

## Stroke Checker

- Accurately measure strokes up to 6"
- Works with any precision caliper to accurately measure crankshaft strokes
- Measures strokes up to 6" with an accuracy of .001"
- Rigid, hard-anodized aluminum frame is fully adjustable
- Fits almost any crankshaft
- Order No. **CSG-1** Jobber \$178.49

See page 120 for our selection of calipers

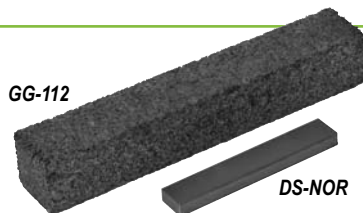

## Hand-Held Dressing Sticks

- Keep your crankshaft grinding wheels cutting clean

Description	Jobber	Order No.
1" x 1" x 6" • Hard Silicon-Carbide • Use to deglaze wheel side • Removes material with pressure	\$19.79	GG-112
¾" x ½" x 3" • Dense, granular Norbide®	62.99	DS-NOR

## Crankshaft Straightening Peening Tool

- Designed for narrow Journals on some new-style V6 crankshafts
- Peen crankshafts in the radius area of damaged journals to straighten
- Long-shank
- Offset-radius face
- 10" long • 0.0625" radius
- 0.125" diameter

Description	Jobber	Order No.
Peening Tool	\$43.79	CPT-062
Safety Glasses	4.99	PGL-21



**tech tips**  
from the techxperts™  
**Stay Safe In The Workplace!**  
Always wear safety glasses.

**In-stock for immediate shipping!**

## Crankgrinder Steady Rest Shoes

- Perfect replacements for OE steady-rest shoes on most common machines
- If you can't find your shoe in our chart, fax or email a photocopy or outline of it for immediate identification (1-888-466-3909 or 1-507-452-2907) • Many more choices available by special order, call **1-800-533-8010** to inquire

RSV-15A710



RSV-15A709



RVN-43842



RZN-2411

Upper Shoe			Lower Shoe	
Thickness	OE No.	Order No.	OE No.	Order No.
<b>PETERSON-BERCO</b>				
5/16"		RBE-200		same as upper
<b>SCLEDUM / DCM TECH</b>				
1/4"	90069	RSC-237350N		same as upper
5/16"	90046	RSC-237350W		same as upper
<b>STORM VULCAN</b>				
3/8"	148-25	RSV-148025		
1/4"	15A-170-10	RSV-15A170	15A-170-9	RSV-15A179
3/8"	15A-70-10	RSV-15A710	15A-70-9	RSV-15A709
3/8"	15C-70-10	RSV-15C710	15C-70-9	RSV-15C709
<b>SCHOU</b>				
3/8"		RSC-15260		same as upper
<b>WINONA VAN NORMAN</b>				
475-477			111-5446	RVN-1115446
475-477	438-42	RVN-43842		
475-477	475-401	RVN-475401		
477	666-5418	RVN-6665418		
477			448-354	RVN-448354
<b>WINONA VAN NORMAN / ZANROSSO</b>				
250, 280	816130	RZN-2150		same as upper
MITO280	811365	RZN-2365		
250	811365	RZN-2365		same as upper
280	811365	RZN-2365		
210			815390	RZN-2390
250, 280	811410	RZN-2410	811411	RZN-2411
250	815801	RZN-2801	815802	RZN-2802

Jobber \$24.99 each

Jobber \$24.99 each

If you can't find your shoe in our chart, fax or email us a photocopy of it for immediate identification. Toll Free Fax: 1-888-466-3909



## Crankshaft Journal Radius Gauge

- 16 radii ... 1/32" to 1/64"
- Measure radii or reground journals quickly
- Blades are clearly marked in 1/64" increments
- Use in holder or remove
- Order No. **RG-16** Jobber \$39.99

Easy to adjust for different heights

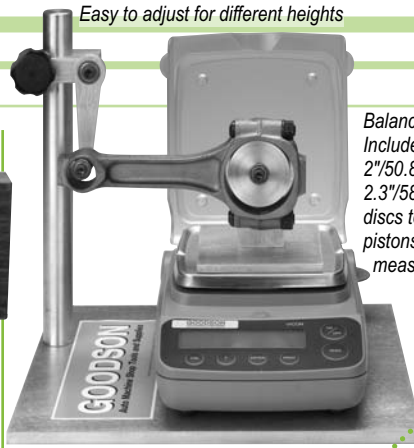

Balancing Stand Includes 2" / 50.8mm and 2.3" / 58.4mm discs to support pistons while measuring

Flip-up cover protects scales when not in use

Large, easy to read digital display

## Electronic Scales & Balancing Stand

- Easy to read digital display
- Trays measure 5 1/2" x 5"
- Ideal for static balancing parts
- Also use to weigh rotating and reciprocating masses and record the information for dynamic balancing
- Scales feature automatic tare weight correction
- Operates on 9V battery (not included) or 110V converter (included) • Low battery indicator

Capacity	Increments		Jobber	Order No.
	Gram	Ounce		
4100 Gram Scale	1.0	0.100	\$269.99	BS-200
5100 Gram Scale	0.1	0.001	\$79.99	BS-4800
Rod Balancing Stand			249.99	BS-201

## Heavy Metal

An essential component when balancing rods & pistons to crankshafts to ensure proper engine operation.



HEAVY METAL - TUNGSTEN							
Hole in	Press Fit + in/mm	1.0" Long		1.2" Long			
		Grams	Jobber	Order No.	Grams	Jobber	Order No.
1/2"	.002"/.05	57	\$21.99	HM-57	65	\$23.99	HM-72
3/4"	.002"/.05	122	24.99	HM-122	147	29.99	HM-162
7/8"	.002"/.05	169	32.99	HM-169	198	39.99	HM-198
1"	.002"/.05	227	47.99	HM-227	265	54.99	HM-265

NOTE: Due to market fluctuations, heavy metal prices are subject to change without notice. Please confirm pricing when ordering.

## Universal Quick-Set Crankgrinder Dial Indicator

- 3/8" diameter shaft • 12" long.
- .125" travel, .050" per revolution
- Rotating, lockable bezel graduated in .001" from -.025" to +.025"
- Order No. **MDI-12** Jobber \$359.99



More Dial Indicators on page 120

Starrett

**Full Service  
FAST!**



"If you're not sure what to order or if you have any questions, give us a call! We're here from 8am to 5pm Central Time, weekdays to serve you. We can help you get the most from our products and your equipment."

- Chris, Goodson ASE-Certified Master Machinist, 28 years of service

CYLINDER HEAD REBUILDING  
CLEANING, ASSEMBLY & SAFETY  
SHORT BLOCK REBUILDING  
CRANKSHAFT/ FLYWHEEL GRINDING  
MISCELLANEOUS TOOLS & SUPPLIES  
BRAKE & TIRE CHANGING TOOLS  
MEASURING TOOLS  
V-TWIN & METRIC HARD PARTS

**Outstanding flexibility!  
Belts conform to the  
crankshaft better.**

**Premium Aluminum-Oxide Crank Polishing Belts**

- J-weight cloth-backing with a high strength mylar joint
- Phenolic resin-over-resin bond • Aluminum oxide abrasive
- Polish better and outlast other standard polishing belts
- Color may vary due to manufacturing process

**Try our Sample Packs!**

5 of our most popular belts

Belt Size	Jobber	Order No.
64"	\$19.99	PCP-64PAK
72"	19.99	PCP-72PAK

**STRAIGHT-EDGE (10 per box)**

Lgth	Wdth	Jobber	240 grit	Jobber	320 grit	Jobber	400 grit	Jobber	600 grit	Jobber	800 grit
60"	¾"	\$31.99	R60x¾x240	\$31.99	R60x¾x320	\$31.99	R60x¾x400	\$31.99	R60x¾x600	\$31.99	R60x¾x800
	1"	36.99	R60x1x240	36.99	R60x1x320	36.99	R60x1x400	36.99	R60x1x600	36.99	R60x1x800
64"	¾"	34.99	R64x¾x240	34.99	R64x¾x320	34.99	R64x¾x400	34.99	R64x¾x600	34.99	R64x¾x800
	1"	43.99	R64x1x240	43.99	R64x1x320	43.99	R64x1x400	43.99	R64x1x600	43.99	R64x1x800
	1½"	43.99	R64x1½x240	43.99	R64x1½x320						
	1½"	46.99	R64x1½x240	46.99	R64x1½x320						
	1¾"	49.99	R64x1¾x240	49.99	R64x1¾x320						
	2"	59.99	R64x2x240	59.99	R64x2x320						
72"	¾"	36.99	R72x¾x240	36.99	R72x¾x320	\$36.99	R72x¾x400	\$36.99	R72x¾x600	\$36.99	R72x¾x800
	1"	43.99	R72x1x240	43.99	R72x1x320	43.99	R72x1x400	43.99	R72x1x600	43.99	R72x1x800
	1½"	45.99	R72x1½x240	45.99	R72x1½x320						
	1½"	48.99	R72x1½x240	48.99	R72x1½x320						
	1¾"	51.99	R72x1¾x240	51.99	R72x1¾x320						
77"	¾"	37.99	R77x¾x240	37.99	R77x¾x320	\$37.99	R77x¾x400	\$37.99	R77x¾x600	\$37.99	R77x¾x800
	1"	44.99	R77x1x240	44.99	R77x1x320	44.99	R77x1x400	44.99	R77x1x600	44.99	R77x1x800
91"	¾"					41.99	R91x¾x400	41.99	R91x¾x600	41.99	R91x¾x800
	1"			\$46.99	R91x1x320	46.99	R91x1x400	46.99	R91x1x600	46.99	R91x1x800

**Back by  
popular demand**

All abrasives are guaranteed for 1 year from the original purchase date.



**SAVE 10% off jobber!**

Order 5 or more boxes of crank polishing belts (any combination)

**Micro Finish  
Scotch-Brite Style  
Abrasive Rolls**

- Ideal for hand polishing of high-performance crankshafts
- Non-directional polish
- Won't remove material
- Aluminum oxide abrasive with a high-strength resin bond
- Measure: ¾"x10"
- 1 Per Box
- Order No. **GFR-750**  
Jobber \$29.99



**Premium  
Micro Polishing Belts**

- Use with our polishing rouge
- Structured Abrasive
- 5 per box

Size (LxW)	Jobber	Order No.
60"x1"	\$36.49	GSW-60x1
64"x1"	36.49	GSW-64x1
70"x1"	36.49	GSW-70x1
72"x1"	39.99	GSW-72x1
77"x1"	39.99	GSW-77x1
Polishing Rouge	11.99	CPR-16



**How to care for your  
Crankshaft Polishing Belts**

- Always release belt tension when not in use.
- Store belts in a dry, cool area.
- Date your polishing belt boxes when you receive them; abrasives break down over time. Goodson guarantees abrasives for 1 year from the original purchase date.
- Use appropriate accessories with your belts – Grind Aid (**GRA-10**), Polishing Rouge (**CPR-16**) and Abrasive Dresser (**ACB-224**) to improve polishing process and prolong belt life.

**tech tips**  
from the techxperts™

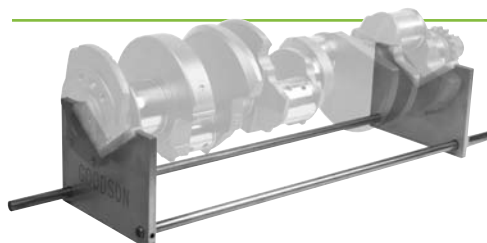

**Professional Measuring & Inspection  
Stand For Cranks & Cams**

- Length adjusts up to 23" to fit journal spacing
- Rotate work to view or measure
- Solid aluminum frame with self-lubricating, corrosion and chemical-resistant wear surfaces
- Order No. **PMIS-30** Jobber \$124.99

**SAVE 10%  
off jobber!**

Order 5 or more boxes of crank polishing belts (any combination)



# Crankshaft Polishing

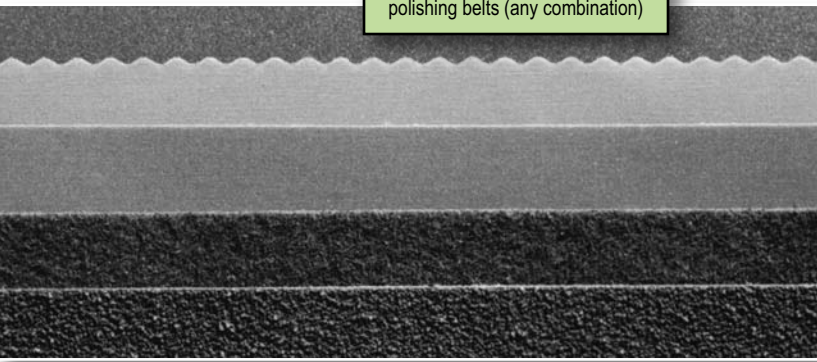

## Standard Polishing Belts

Good quality, flexible, woven cloth-back belts polish better and outlast other general-use belts. New belts can be used to remove minor journal damage without grinding while broken-in belts give a fine finish. Aluminum oxide abrasive. 2-layer glue bond. Colors may vary due to manufacturing.

STANDARD STRAIGHT-EDGE (10 per box)							
Lgth	Wdth	Jobber	240 grit	Jobber	320 grit	Jobber	400 grit
60"	3/4"			\$28.99	60x3/4x320	\$28.99	60x3/4x400
	1"	\$31.99	60x1x240	31.99	60x1x320	31.99	60x1x400
64"	3/4"	29.99	64x3/4x240	29.99	64x3/4x320	29.99	64x3/4x400
	1"	36.99	64x1x240	36.99	64x1x320	36.99	64x1x400
	1 1/2"	42.99	64x1 1/2x240				
	1 3/4"	49.99	64x1 3/4x240	49.99	64x1 3/4x320		
70"	2"	54.99	64x2x240	54.99	64x2x320		
	3/4"			31.99	70x3/4x320		
	1"	36.99	70x1x240	36.99	70x1x320	36.99	70x1x400
72"	1 1/4"			39.99	70x1 1/4x320		
	1/2"			26.99	72x1/2x320	26.99	72x1/2x400
77"	3/4"	32.99	72x3/4x240	32.99	72x3/4x320	32.99	72x3/4x400
	1"	38.99	72x1x240	38.99	72x1x320	38.99	72x1x400
	1 1/4"	42.99	72x1 1/4x240	42.99	72x1 1/4x320		
	1 3/4"	49.99	72x1 3/4x240	49.99	72x1 3/4x320		
	2"	63.99	72x2x240	63.99	72x2x320		
	3/4"			34.99	77x3/4x320		
91"	1"	41.99	77x1x240	41.99	77x1x320	41.99	77x1x400
	1 3/4"			61.99	77x1 3/4x320		
	2"			65.99	77x2x320		
91"	3/4"	35.99	91x3/4x240	35.99	91x3/4x320		
	1"	43.99	91x1x240	43.99	91x1x320	43.99	91x1x400
	1 1/4"			56.99	91x1 1/4x320		
	1 3/4"			63.99	91x1 3/4x320		
	2"			66.99	91x2x320		

All abrasives are guaranteed for 1 year from the original purchase date

## Standard Scalloped Edge Crankshaft Polishing Belts

- 10 per box • 320 grit • 1" wide
- Ideal for radius polishing

Length	Jobber	Order No.
64"	\$34.99	S64x1x320
72"	36.99	S72x1x320
91"	56.99	S91x1x320

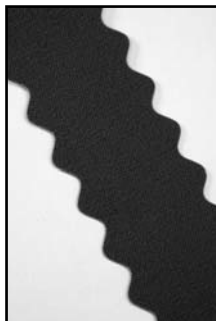

**tech tips** Store belts and abrasives in a dry, moisture free area.  
from the techxperts™

## Fine Finish

- Aluminum-oxide • Flexible, woven back • 2-layer resin bond
- Very aggressive • Sharper grains cut faster without sacrificing finish • The Blue Backed Belt

Fine Finish (10 per box)					
Lgth	Wdth	Jobber	320 grit	Jobber	400 grit
60"	1"	\$37.99	G-60x1x320	\$39.99	G-60x1x400
64"	1"	39.99	G-64x1x320	39.99	G-64x1x400
72"	1"	42.99	G-72x1x320	43.99	G-72x1x400
77"	1"	47.99	G-77x1x320	47.99	G-77x1x400
91"	1"	69.99	G-91x1x320	69.99	G-91x1x400



## Scotch-Brite Style Micro Finish

- Rigid, 3-dimensional back • Resin bond • Aluminum-oxide abrasive • Non-directional finish

Micro-Finish (1 per box)				
Length	Width	Jobber	Order No.	
60"	3/4"	\$29.99	GFB-60 x 3/4	
	1"	29.99	GFB-60 x 1	
64"	3/4"	29.99	GFB-64 x 3/4	
	1"	29.99	GFB-64 x 1	
70"	3/4"	29.99	GFB-70 x 3/4	
	1"	29.99	GFB-70 x 1	
72"	3/4"	29.99	GFB-72 x 3/4	
	1"	29.99	GFB-72 x 1	
77"	1"	29.99	GFB-77 x 1	
	1"	29.99	GFB-91 x 1	

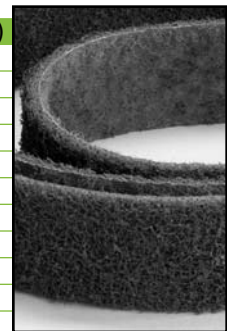

## Scotch-Brite Style Super-Micro Finish

- Produces a mirror-like non-directional finish • Resin bond
- Silicon-Carbide abrasive • For final finish

Super-Micro Finish (1 per box)			
Length	Width	Jobber	Order No.
60"	3/4"	\$27.99	SGFB-60 x 3/4
	1"	29.99	SGFB-60 x 1
64"	3/4"	30.99	SGFB-64 x 3/4
	1"	30.99	SGFB-64 x 1
70"	3/4"	30.99	SGFB-70 x 3/4
	1"	30.99	SGFB-70 x 1
72"	3/4"	31.99	SGFB-72 x 3/4
	1"	32.99	SGFB-72 x 1
77"	3/4"	32.99	SGFB-77 x 3/4
	1"	33.99	SGFB-77 x 1
91"	3/4"	35.99	SGFB-91 x 3/4
	1"	35.99	SGFB-91 x 1

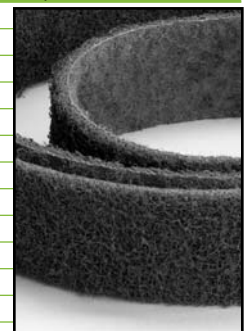

## Abrasive Cork Super-Fine Finish

- Satin finish • Won't disturb polished radii • Silicon-carbide

Abrasive Cork (1 per box)			
Length	Width	Jobber	Order No.
64"	3/4"	\$14.99	CPB-64-3/4
	1"	14.99	CPB-64-1
70"	3/4"	14.99	CPB-70-3/4
	1"	14.99	CPB-70-1
72"	3/4"	14.99	CPB-72-3/4
	1"	14.99	CPB-72-1
77"	3/4"	14.99	CPB-77-3/4
	1"	14.99	CPB-77-1
91"	3/4"	14.99	CPB-91-3/4
	1"	14.99	CPB-91-1



CYLINDER HEAD REBUILDING  
CLEANING, ASSEMBLY & SAFETY  
SHORT BLOCK REBUILDING  
CRANKSHAFT/FLYWHEEL GRINDING  
MISCELLANEOUS TOOLS & SUPPLIES  
BRAKE & TIRE CHANGING TOOLS  
MEASURING TOOLS  
V-TWIN & METRIC HARD PARTS

CYLINDER HEAD REBUILDING  
CLEANING, ASSEMBLY & SAFETY  
SHORT BLOCK REBUILDING  
CRANKSHAFT/ FLYWHEEL GRINDING  
MISCELLANEOUS TOOLS & SUPPLIES  
BRAKE & TIRE CHANGING TOOLS  
MEASURING TOOLS  
V-TWIN & METRIC HARD PARTS

## Crankshaft Polishing Starter Kit

Includes 1 each of:

- Grind Aid,
- Polishing Rouge,
- Abrasive Dresser and
- 5-Pack of our most popular 72" belts
- Order No. **CP-KIT** Jobber \$57.99



## Grind Aid

- Cools and lubricates
- Reduces loading-up and grain fracturing
- Belts produce a better finish & last up to twice as long • Use only on cloth-back belts such as those shown on pages 98 & 99
- Order No. **GRA-10** Jobber \$16.99



## Polishing Rouge

- Produces high luster finish
- Use with light pressure, for cork or fine grit polishing to finish crank journals perfectly
- Hard, dry compound becomes viscous with heat • White • 16 oz. / 454 g
- Order No. **CPR-16** Jobber \$11.99



## Abrasive Dresser

- Prolongs belt life
- Hold at 45° angle on moving belt to remove foreign material
- Restores cutting ability of grains
- 2" x 2" x 4" / 51 x 51 x 102mm
- Order No. **ACB-224** Jobber \$17.99

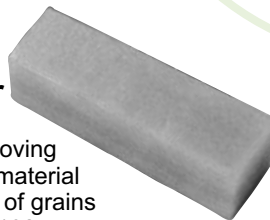

## Heavy Duty Steel Stamps

- For hard materials
- Order in sets or individually
- For a single stamp, state character desired after Order No.  
Example: **SCH-1/4(A)** Single Character stamp, 1/4" size, Letter "A"



Number Sets			
Char. Size	Shank Size	Jobber	Order No.
1/8"	5/16"	\$44.99	SFH-1/8
3/16"	3/8"	49.99	SFH-3/16
Single Characters			
3/16"	3/8"	\$8.99	SCH-3/16
1/4"	7/16"	8.99	SCH-1/4

Special and custom orders are available, call 1-800-533-8010

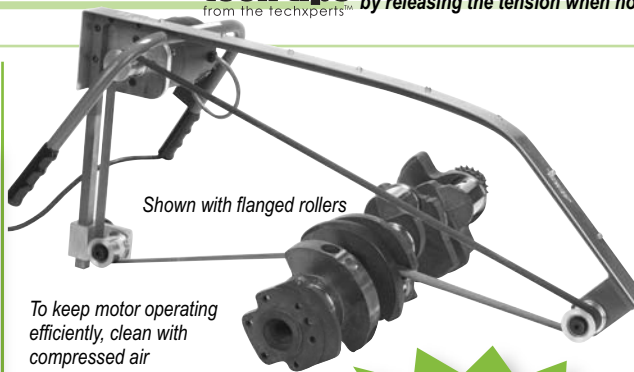

Shown with flanged rollers

To keep motor operating efficiently, clean with compressed air regularly.

**American Made**

Includes 5 of our most popular 72" Belts (PCP-72PAK) A \$19.99 value

## 72" Crankshaft Polisher

- Flex resistant steel frame
- Weighs 15 lbs. (6.8 kg) • Crowned rollers keep snug belt running true • 1" nominal = 1.625"
- 2" nominal = 2.625" • Specify flanged or unflanged rollers when ordering

Roller Width		HP	Max. RPM	Jobber	Order No.
Nominal	Actual				
1"/25mm	1.625"/41mm	1/2	10,000	\$ 999.99	PCP-1072
2"/51mm	2.625"/67mm	1/2	10,000	1,049.99	PCP-1072-2

Replacement Parts and Rollers		Includes
Flanged Roller Sets	1"	\$144.99 PCP-1
(3 piece set)	2"	164.99 PCP-2
Unflanged Roller Sets	1"	144.99 PCP-1S
(3 piece set)	2"	195.99 PCP-2S
Flanged Drive Roller	1"	54.99 PCP-1D
Fits 3/8" shaft - 1 ea.	2"	57.99 PCP-2D
Flanged Roller Assembly	1"	57.99 PCP-1F
3/8" x 16 thread - 1 ea.	2"	79.99 PCP-2F
Unflanged Roller Assembly	1"	61.99 PCP-1-1EA
3/8" x 16 thread - 1 ea.	2"	69.99 PCP-2-EA
Bearing - 1 ea.		13.99 PCP-BRG
Replacement Switch		25.29 PCP-SWITCH-72
Replacement Motor		599.99 PCP-MOTOR-72

## 220 Volt, 50 cycle Motor Export Model

Roller Width		HP	Max. RPM	Jobber	Order No.
Nominal	Actual				
1"	1.625"	1/2	10,000	\$1,049.99	PCP-1072E
2"	2.625"	1/2	10,000	1,049.99	PCP-1072-2E
Replacement Motor				569.99	PCP-1072E-M



## Crank Welding Rods

- 3 diameters available
- Each rod is 12 1/2" long and cuts out easily
- Sharpen ends with your existing pencil sharpener
- 5 Crank Welding Plug Rods per pack

Size	Jobber	Order No.
.250"	\$15.79	CWPR-250
.312"	15.79	CWPR-312
.375"	15.79	CWPR-375



# Crankshaft & Flywheel Tools

## Dampener Installer

- Install harmonic dampeners without thrust bearing damage
- Screw tool into hole in the crankshaft end
- Use the nut and thrust bearing to draw the harmonic dampener onto the crankshaft snout
- Fits 7/16" x 20" and 1/2" x 20" holes • 3 piece set
- Order No. **DIT-2** Jobber \$74.29

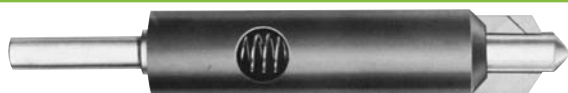

## Eliptibur Tool

- Fastest, safest way to chamfer crank oil holes
- Simplify deburring and chamfering of angularly drilled holes on cylindrical surfaces
- Easily produces a chamfer of relative uniformity and depth
- Self-centering, spring loaded pilot
- Includes one replaceable blade
- For 30Rc or softer crankshafts

Description	Jobber	Order No.
Eliptibur Tool (1 blade included)	\$259.99	<b>EBT-15</b>
Replacement Blades	39.99	<b>EBT-15B</b>

## Flywheel Saver Shims

Many clutch linkages aren't adjustable, so you must return the flywheel friction surface to original position after resurfacing or faulty clutch action and possible failure can occur. These shims let you grind a flywheel instead of replacing it. Shims install between the crank flange and flywheel to compensate for .025" or .050" of grinding. View shims on Goodson.com



Chrysler	Dia.	Thick	Order No.
5.7, 5.9 (Diesel), 7.5 and 8.1 Liter Engines	5.125"	.025"	<b>FSS-810-25</b>
shims have break-off tabs to fit 4.316" & 3.750" ODs		.050"	<b>FSS-810-50</b>
Ford			
1.6, 1.9, 2.0, 2.3, 3.0, 3.3, 3.1, 3.8, 3.9 (240ci), 4.1 (250 ci), 4.2 (255ci), 4.7 (289ci), 4.9 (300ci), 5.0 (302ci), 5.8 (351ci)	3.625"	.025"	<b>FSS-468-25</b>
		.050"	<b>FSS-468-50</b>
5.7 (352ci), 5.9 (360ci), 6.4 (390ci), 6.9 Diesel (420ci), 7.0 (427ci) 7.5 (460ci)	5.000"	.025"	<b>FSS-460-25</b>
General Motors			
2.0, 2.2, 2.5, 2.8, 3.1	3.000"	.025"	<b>FSS-628-25</b>
		.050"	<b>FSS-628-50</b>
2.3, 3.3, 3.7, 3.8, 4.1, 4.3, 4.6, 5.0, 5.4, 5.7, 6.0, 6.2 Diesel, 6.5, 6.6 Diesel, 6.6, 6.7 (402ci), 7.0 (427ci), 7.4 (454ci)	4.500"	.025"	<b>FSS-857-25</b>
		.050"	<b>FSS-857-50</b>
2.2, 2.3, 3.8, 4.3	3.750"	.025"	<b>FSS-643-25</b>
4.2, 4.8, 5.3, 6.0 and 6.6 (diesel)	4.056"	.025"	<b>FSS-866-25</b>
Jeep			
2.5, 2.8, 3.1, 4.0 (GM Engine)	3.000"	.025"	<b>FSS-628-25</b>
		.050"	<b>FSS-628-50</b>

Jobber \$11.99

**Note:** Shims shaded in light green can be stacked to a total thickness of .075." Other shims are available by special order

All Steel Construction

Goodson  
exclusive



## Reluctor Ring Installation Tool

- Adjustable depth for popular flange widths
- Fits Generation III engines: 4.8/LR4, 5.3/LM7 and 6.0/LQ4
- Aligns GM# 12559353 & 12586768 Sensor Rings on the crankshaft in the correct phased position
- Indexes in dowel hole of flange to dowel hole in sensor ring

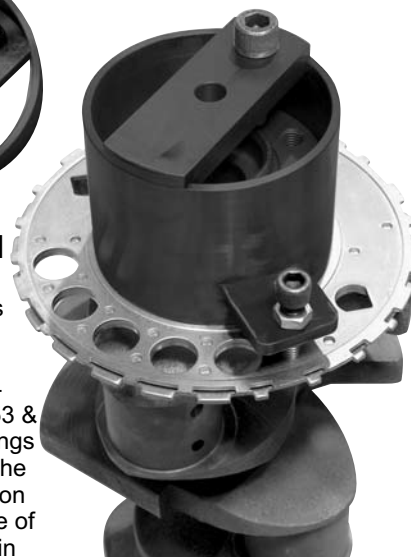

US PATENT NO. 7,716,827

Description	Jobber	Order No.
Reluctor Ring Installation Tool	\$199.99	<b>RRJ-350</b>
Temperature Indicating Crayon (450° F/232°C)	16.99	<b>TIC-450</b>

**INSTALLATION TIP:** Heat reluctor ring to 450°F (232°C) then slide it onto the casting. Be sure to deburr all components before beginning assembly. Any sharp edges will cause the reluctor ring to catch on the casting, making assembly impossible.

## Flywheel Grinder Bolt Adaptors

- Replace shoulder bolts with standard hardware
- Low-cost adaptor converts any 1/2" or 7/16" bolt to a 3/4" ID
- Includes countersunk adaptor with bolts for extra clearance

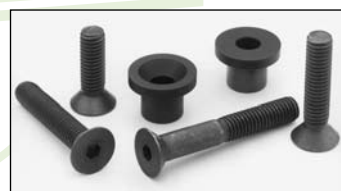

FG-LOCK

Fits	Size	Jobber	Order No.
WVN	7/16" x 14	\$33.99	<b>FG-AB-KIT</b>
WVN Table Insert	OD: 5/8" x 11, ID: 7/16" x 14	6.79	<b>FG-LOCK</b>
DCM, Peterson, KW	1/2" x 13	33.99	<b>FG-DCP-KIT</b>



## Flywheel Radius Cutter Tip Holder

- For WVN/VN FG-5000 • Holder measures 1.5"L with a .312" dia. shank
- Includes 1 indexable FG-3B cutter tip

Description	Jobber	Order No.
Tip Holder	\$108.99	<b>FG-5011</b>
Replacement Tip	9.99	<b>FG-3B</b>

Order 5 or more, take 10% off jobber!

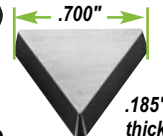

## Flywheel Cutter Tip For Winona Van Norman 570 Rotary Broach

- 3-edge carbide cutting tip for use with the special flywheel attachment
- Order **VN-FW** Jobber \$13.99

# From our customers



"Whatever race track we're at and happen to run low on flywheel grinding wheels, they are just a phone call or email away. They'll even ship to wherever we are working. I call that SERVICE with a smile."

- Tim Hyatt, Hyatt Racing Service - Goodson Customer since 1996

CYLINDER HEAD REBUILDING  
CLEANING, ASSEMBLY & SAFETY  
SHORT BLOCK REBUILDING  
CRANKSHAFT/ FLYWHEEL GRINDING  
MISCELLANEOUS TOOLS & SUPPLIES  
BRAKE & TIRE CHANGING TOOLS  
MEASURING TOOLS  
V-TWIN & METRIC HARD PARTS

It is essential, when pulling a dowel, that the tightening sleeve is installed with the flared end toward the collet. This will allow the tightening sleeve to slide over the collet, locking it to the dowel you are removing. Also, be sure to select the correct collet size for the dowel you are removing.

## tech tips from the techxperts™

### Dowel Puller and Collets

- Slide hammer action removes stubborn dowels
- Use on blocks, heads, flywheels, etc.
- Split collets grip firmly without causing damage
- A high-quality tool that lets you reuse dowel pins
- Choose from SAE or Metric kits
- All items also sold separately

Description	Jobber	Order No.	Incl.
<b>Standard Kit</b>	\$189.99	<b>GA-600</b>	
<b>Metric Kit</b>	189.99	<b>GA-600M</b>	
<b>Slide Shaft</b>	12.49	<b>GAO-1</b>	x x
<b>Slide Hammer</b>	21.99	<b>GAO-2</b>	x x
<b>Tightening Sleeve</b>	34.99	<b>GAO-3</b>	x x
<b>Gripping Collets</b>			
OD ID mm			
1" .1575"	4.00	\$34.99	<b>GAO-22</b> x
1" .1875"	4.76	34.99	<b>GAO-4</b>
1" .1969"	5.00	34.99	<b>GAO-13</b> x
1" .2362"	6.00	34.99	<b>GAO-14</b> x
1" .2500"	6.35	34.99	<b>GAO-5</b> x
1" .2756"	7.00	34.99	<b>GAO-26</b>
1" .3125"	7.94	34.99	<b>GAO-6</b> x
1" .3150"	8.00	34.99	<b>GAO-10</b> x
1" .3750"	9.53	34.99	<b>GAO-7</b> x
1" .3937"	10.00	34.99	<b>GAO-23</b>
1" .4375"	11.11	34.99	<b>GAO-8</b> x
1" .4724"	12.00	34.99	<b>GAO-24</b>
1" .5000"	12.70	34.99	<b>GAO-9</b>
1" .5512"	14.00	34.99	<b>GAO-25</b>
1" .5625"	14.29	34.99	<b>GAO-19</b>
1" .6250"	15.88	34.99	<b>GAO-20</b>
1" .6400"	16.26	34.99	<b>GAO-15</b>
1" .6750"	17.15	34.99	<b>GAO-11</b>
1" .6875"	17.46	34.99	<b>GAO-17</b>
1" .7350"	18.67	34.99	<b>GAO-12</b>
1" .7500"	19.05	34.99	<b>GAO-18</b>
1" .8000"	20.32	34.99	<b>GAO-16</b>
<b>Removal Basin</b>	23.99	<b>GAO-21</b>	x x

Parts are stamped for easy identification & reordering



## tech tips Always use clean, fresh coolant for grinding with CBN Flywheel Stones

### CBN\* Flywheel Grinding Wheels For Cast Iron

- Aluminum core • 1/8" thick CBN material
- 1 1/4"/31.75mm arbor • Several sizes to choose from
- Standard 1 1/4" grinding arbor - no adaptors needed

Nominal Size & Description	Jobber	Order No.
3" diameter CBN wheel - straight sides	\$189.99	<b>ECBN-300</b>
4" diameter CBN wheel - flared sides	199.99	<b>ECBN-4</b>
6" diameter CBN wheel - flared sides	219.99	<b>ECBN-6</b>
CBN Dressing Stick - 1/2"x1/8"x6"	16.99	<b>DS-CBN</b>
Flywheel Grinding Coolant - 1 gallon/3.78L	41.99	<b>FG-1101-G</b>

\* Cubic Boron Nitride

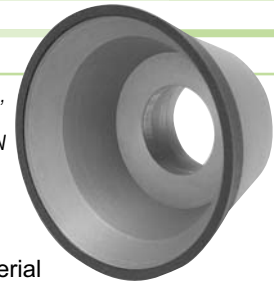

### Flywheel Depth Gauge with Dial Indicator

- Measure flywheel before and after grinding to maintain proper depth specifications
- Spindle Extensions sold separately

Description	Jobber	Order No.
Gauge	\$129.99	<b>FGG-12</b>
Spindle 1.5"	7.99	<b>DIS-1.5</b>
Extensions 2.5"	10.49	<b>DIS-2.5</b>
3.0"	15.79	<b>DIS-3.0</b>

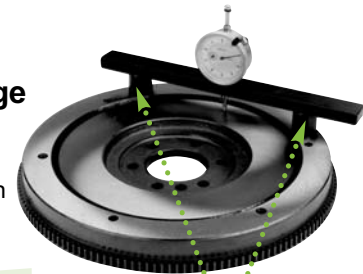

Magnetic feet adjust to flywheel diameter

### Pin Pal Puller

- Remove dowels fast
- Adjusts to pull all sizes of dowels
- Vise-grip jaws hold firm while 4 lb. slide hammer forces dowels out
- Also pulls pressed-in hollow tubes or frozen shafts
- Rugged steel construction

Description	Jobber	Order No.
Complete Tool	\$289.99	<b>GA-300</b>
Replacement Jaws	79.99	<b>GA-300E-R</b>



GS-10



GS-17A



FG-1165-G



FG-1070A-G



FG-1045-G



GS-14



GS-17

## Grinding Wheel Dressers & Replacement Cutters

Diamond Dresser tools available on page 104-105

Applications	Cutter Assemblies				Replacement Cutters					
	OD	ID	W	Jobber	Order No.	Pieces	Washers	Size	Jobber	Order No.
VN, Lempco, Storm RT-7Y, 17Y	2.500"	1.500"	.0625"	\$84.99	<b>GS-10</b>	14 stars	1 w/locking tangs	1.75" x .058"	\$22.99	<b>GS-14</b>
Peterson (12mm shaft)	2.375"	1.500"	.0938"	87.99	<b>GS-17A</b>	8 stars	5 1 w/locking tangs	2" x 1.50" x .028" 1.75" x 1.5" x .06"	22.99	<b>GS-17</b>
WVN SM2000, 4000, 5000, 6000C, 6000A, MG3000, 3850	1.250"	0.313"	.0625"	29.99	<b>FG-1165-G</b>	7 stars	none	1.25" x .313" x .095"	7.99	<b>FG-1161-G</b>
Peterson & DCM	2.375"	1.125"	.125"	69.99	<b>FG-1070A-G</b>	5 stars	1	1.624" dia. x .031"	15.99	<b>FG-1070-G</b>
Hand held				49.99	<b>FG-1045-G</b>	1 stone	none	1.500"x.313"x.625"	13.99	<b>FG-1044-G</b>



# Flywheel Grinding Stones



## Flywheel Grinding Coolant

- Formula eliminates rancid coolant
- Synthetic inhibitors • Dilute 30:1

Size	Jobber	Order No.
1 Gal./3.78L	\$ 41.99	FG-1101-G
5 Gal./18.8L	149.99	FG-1102-G

## Flywheel Grinding Stones For best results... choose the right stone from Goodson

Goodson stones feature 50% more useable abrasive and much stronger construction, yet sell at prices comparable to ordinary stones. With Goodson stones you'll get longer wheel life and lower-cost flywheel grinding.

### Cast Iron:

Cast Iron (soft) flywheels need to be ground with harder stones. Experiment to find the best stone. A good starting point is the **FGW-57**, our best all-around stone for Cast Iron.

### Cast Steel:

Cast Steel (medium) flywheels require medium-hard stones. The **FGW-65** is our best all-around stone for Cast Steel.

### Billet Steel:

Billet Steel (very hard) flywheels need to be ground with softer stones. Our best all-around stone for Billet Steel is the **FGW-50-2**. It's our most friable and free-cutting, requiring minimal dressing.

See the Goodson Tech Library at [goodson.com](http://goodson.com) for more tips on choosing the right Flywheel Grinding Stone.

## Mounting Adaptor For Small Diameter Stones

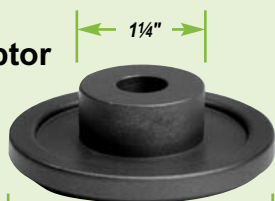

- Many flywheel grinders have lower mounting flanges that won't fit inside 3" and 4" diameter flared-cup stones
- Use this adaptor to avoid damage when mounting small stones
- Fits most small diameter stones
- Order No. **FG-FLANGE** Jobber \$11.99

## 10% off jobber!

Order 5 or more flywheel grinding stones (any combination)



### tech tips

from the techxperts™ Be sure to use ample coolant to flush away swarf and help the stones perform better.



## CAST IRON (Passenger cars, light trucks)

Size	Description	Jobber	Order No.
6"-4 1/2" x 2 5/8" x 1 1/4"	Harder than FGW-57, lasts longer, black	\$49.99	<b>FGW-67</b>
6"-4 1/2" x 2 5/8" x 1 1/4"	Best all-around for cast iron, black	49.99	<b>FGW-57</b>
6" x 2 1/2" x 1 1/4"	Straight-sided FGW-57, black	48.99	<b>FGW-57S</b>
6"-4 1/2" x 2 5/8" x 1 1/4"	Softer than FGW-57, grinds faster, black	44.99	<b>FGW-47</b>
6"-4 3/4" x 2 7/8" x 1 1/4"	Silicon-carbide, ideal for top fuel, black	44.99	<b>FGW-37</b>
4"-3" x 2" x 1 1/4"	Small diameter FGW-57, black	49.99	<b>FGW-61</b>
4"-3" x 2" x 1 1/4"	Small diameter FGW-37, black	29.99	<b>FGW-374</b>
3" x 2" x 1 1/4"	Green Silicon-Carbide, Premium	27.99	<b>FGW-93</b>

## CAST STEEL (Industrial, agricultural, OTR trucks)

Size	Description	Jobber	Order No.
6"-4 1/2" x 2" x 1 1/4"	Harder than FGW-65 lasts longer, lt. gray	\$59.99	<b>FGW-53</b>
6"-4 1/2" x 2 5/8" x 1 1/4"	Best all-around for Cast Steel, speckled	89.99	<b>FGW-65</b>
6"-4 1/2" x 2 5/8" x 1 1/4"	Slightly softer than FGW-65, black	47.99	<b>FGW-495</b>
4"-3" x 2" x 1 1/4"	Small diameter FGW-65, speckled	43.99	<b>FGW-69</b>
6"-4 1/2" x 2 5/8" x 1 1/4"	Softer than FGW-65, grinds faster, black	74.99	<b>FGW-49</b>

## BILLET STEEL (Import vehicles, high-performance)

Size	Description	Jobber	Order No.
6"-4 1/2" x 2 5/8" x 1 1/4"	Harder, ruby stone, lasts longer	\$79.99	<b>FGW-64</b>
6"-4 1/2" x 2 5/8" x 1 1/4"	Harder, pink stone, lasts longer	87.99	<b>FGW-62-1</b>
6"-4 1/2" x 2 1/2" x 1 1/4"	Harder than FGW-50-2, white	57.99	<b>FGW-50</b>
6"-4 1/2" x 2 1/2" x 1 1/4"	Best all-around for Billet Steel	74.99	<b>FGW-50-2</b>
4"-3 1/2" x 1 1/2" x 1 1/4"	Harder, pink stone, lasts longer	39.99	<b>FGW-63-1</b>
4"-3" x 2" x 1 1/4"	Taller than FGW-56, more abrasive, white	44.99	<b>FGW-306</b>
4"-3 1/2" x 1 1/2" x 1 1/4"	Premium	34.99	<b>FGW-56P</b>
4"-3 1/2" x 1 1/2" x 1 1/4"	Small diameter FGW-50	29.99	<b>FGW-56</b>
3"-2 1/4" x 1 1/4" x 3/4"	Small diameter, light gray	27.99	<b>FGW-59</b>
3" x 2" x 1 1/4"	Sugar white stone	24.99	<b>FGW-92</b>

NOTE: Due to manufacturing process, colors may vary.

All abrasives are guaranteed for 1 year from original purchase date.

## 10% off jobber!

Order 5 or more flywheel grinding stones (any combination)



## Flywheel Grinding Stones for Small Arbors and Special Machines

Use	Shape	Diameter	Height	Jobber	Order No.
<b>Winona VanNorman 444 Rotary Grinder - 7/16" Arbor</b>					
Cast Flywheels	Flared	5"-4"	3"	\$129.99	<b>GCV-544</b>
<b>Winona VanNorman 570 Rotary Broach - 1/16" Arbor</b>					
Cast Flywheels	Flared	5"-3 3/4"	1 3/4"	\$84.99	<b>GCV-305</b>

All abrasives are guaranteed for 1 year from original purchase date



**Full Service  
FAST!**



"Our goal is to serve you faster and better than anyone else in the industry. We ship the same day we receive your order so you don't have to wait any longer than necessary. And, remember, if you need your order in a hurry, Goodson can ship it overnight, 2-day or any other way. Just tell us when you need it and we'll get it there."  
- Jon, Texas Customer Service, 20 years of service

shown at approximately full size

CYLINDER HEAD  
REBUILDING

CLEANING,  
ASSEMBLY & SAFETY

SHORT BLOCK  
REBUILDING



G-1



G-1L



G-2



G-3



G-4



G-5



G-6



G-7



G-8

CRANKSHAFT/  
FLYWHEEL GRINDING



G-9



G-11



G-13P



G-15



G-17



G-18



G-19



G-25



G-27

MISCELLANEOUS  
TOOLS & SUPPLIES

BRAKE & TIRE  
CHANGING TOOLS

MEASURING  
TOOLS

V-TWIN & METRIC  
HARD PARTS



G-30



G-32A



G-33



G-80

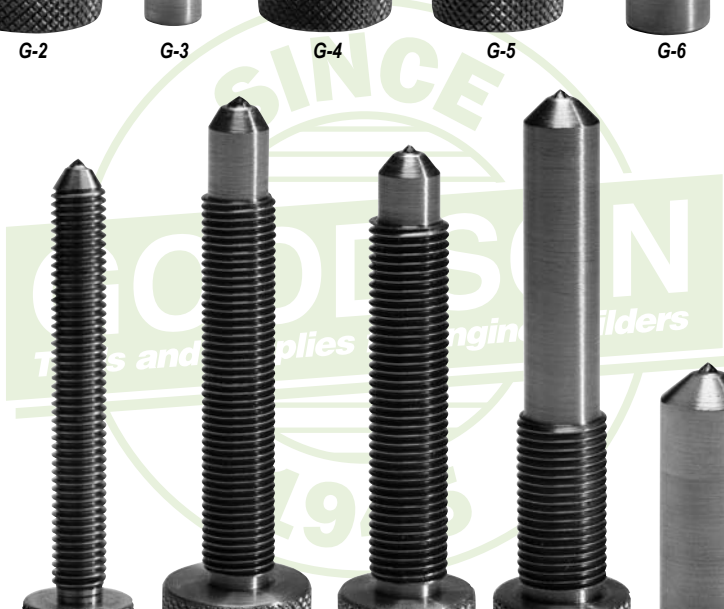

**Diamond:** Selected for very high point definition. A sharper diamond cuts faster and gives a superior finish.

**Matrix:** Matrix material is bronze or copper-based for a tight hold on the diamond & high heat transfer.

**Holder:** Cold rolled steel. Threaded types have precision threads over a long distance to screw easily into tool holders and support cutting point firmly to prevent vibration.

Diamonds are stamped for easy identification and re-ordering

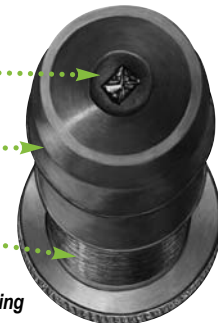

## tech tips

from the techxperts™

- 1. Set tool at a proper angle.**  
Position at 10° to 15° from surface. Smaller angles blunt the diamond. Larger angles may cause the wheel to remove matrix material.
  - 2. Prevent vibration in the holder.** Any looseness in the tool holder will allow vibration of the tool resulting in poor finish on the wheel.
  - 3. Turn coolant on before dressing.** Wheels used wet should be dressed wet. To keep diamond cool, turn coolant on before starting to dress. (If wheel is dressed dry, air-cool diamond between cuts but don't quench with water.)
  - 4. Start at highest point.** Wheels often wear unevenly & may have high & low spots. Set tool to dress high spots first, feed in about .001" per pass until done. This prevents overheating & damage.
  - 5. Use steady travel.** Uneven travel causes an uneven finish. The best rate is found by experiment, but whatever the rate of travel, it must be even.
  - 6. Turn the tool in the holder.** Turn the tool often to expose new diamond surface to the wheel.
  - 7. Don't bump or drop diamond.** They are hard but brittle, and can be harmed if dropped or bumped.
- CAUTION: Grinding wheel must never touch matrix or holder.**

## Diamond Dressers for most shop machines - in stock and ready-to-ship

A diamond tool is only as good as the diamond itself. **GOODSON** diamonds are furnished by the most respected supplier in the U.S. Each is subjected to a microscopic examination by experts and must meet strict standards to be accepted. This rigorous inspection and careful control during manufacturing assures consistent high quality. Our diamond tools deliver the highest levels of performance and longevity.

In addition to our standard diamond tools, **GOODSON** stocks a wide selection of Premium-Quality diamonds. These diamonds last longer and improve wheel performance. They stay sharp longer and have more points so they can be reset more times. Because of this quality, they will dress harder wheels and wheels will need to be dressed less frequently. If you don't see the diamond you need in a premium quality, call **800-533-8010** for a special order.

	Machine	Description	Carat	Standard	Premium	
<b>Valve</b>	B&D, Skil, Sioux™, Thor, VanDorn, WVN	3/8"x1 5/8"	1/8	\$ 33.99 <b>G-1</b>	\$ 67.99 <b>G-1P</b>	
<b>Refacers</b>	Kwik-Way, Tobin Arp (S&D)	5/16"x2 1/2"	1/8	36.79 <b>G-3</b>		
	Kwik-Way, Valve Master (1714)	1/2"x3 1/4" 20NF	1/8	37.79 <b>G-4</b>		
	Sioux™ (1713, 1715), IDL, WVN (CG50, CG80)	3/8"x2 3/4" 24NF	1/8	36.79 <b>G-5</b>	66.29 <b>G-5P</b>	
	IDL, WVN (CG-50, CG-80)	3/8"x3 1/4" 24NF	1/8	41.99 <b>G-80</b>	74.99 <b>G-80P</b>	
	US	7/16"x2"	1/8	36.79 <b>G-6</b>		
	Hall 80, K-W, KO Lee, WVN, KR Wilson	1/4"x1"	1/8	39.99 <b>G-7</b>		
	Skil (Talent)	5/16"x2 1/4" 18NC	1/8	38.99 <b>G-9</b>		
	Kwik-Way	7/16"x2 3/4" 20NF	1/8	36.79 <b>G-17</b>	65.79 <b>G-17P</b>	
	<b>Valve Seat</b>	B&D, S&D, Van Dorn	3/8"x2 1/4" 24NF	1/8	37.99 <b>G-2</b>	
	Kwik-Way	1/2"x3 1/4" 20NF	1/8	37.79 <b>G-4</b>		
<b>Grinders</b>	Sioux™ (1715), K-W (NSG), Thor	3/8"x2 3/4" 24NF	1/8	36.79 <b>G-5</b>	66.29 <b>G-5P</b>	
	Kwik-Way	1/4"x1"	1/8	39.99 <b>G-7</b>		
	Hall HD (13-1938P), Skil, Snap-On, B&D	5/16"x2 1/4" 24NF	1/8	41.99 <b>G-8</b>	66.99 <b>G-8P</b>	
	KO Lee, Skil	5/16"x2 1/4" 18NC	1/8	38.99 <b>G-9</b>		
	Sioux™ Heavy Duty (1715B, 1719)	3/8" hex RH	1/8	59.99 <b>G-11</b>		
	Goodson Universal Wheel Dresser	8mm x 1.25mm	1/8		76.29 <b>G-13P</b>	
	Sioux™ Heavy Duty (1715A)	3/8"x2 3/4" 24NF	1/2	73.49 <b>G-15</b>		
	Kwik-Way Heavy Duty Wheel Dresser	1/2"x3" 20NF	1/8	36.79 <b>G-18</b>	64.99 <b>G-18P</b>	
	<b>Clutch Grinders</b>	Lempco AC, NAC, VAC & Do-ALL	7/16"x2"	1/8	36.79 <b>G-6</b>	
	<b>Piston Grinders</b>	Van Norman 75, 76 & Relio	3/8"x1 5/8"	1/8	33.99 <b>G-1</b>	67.99 <b>G-1P</b>
<b>Storm-Vulcan D-3</b>		7/16"x2"	1/8	36.79 <b>G-6</b>		
<b>Drum</b>	Van Norman (all except 302, 302H)	3/8"x1 5/8"	1/8	33.99 <b>G-1</b>	67.99 <b>G-1P</b>	
<b>Lathes</b>	Barret, V.N. 302, 302H	3/8"x3"	1/8	34.99 <b>G-1L</b>		
	Lempco	7/16"x2"	1/8	36.79 <b>G-6</b>		
	Ammco 5000	1/2"x1 1/2"	1/8	34.79 <b>G-19</b>		
<b>Rod Grinders</b>	Sunnen® Rod & Cap Grinder (CRG-500)	3/8"x1 5/8"	1/8	33.99 <b>G-1</b>	67.99 <b>G-1P</b>	
<b>Storm-Vulcan No. 65 Rod Grinder</b>		1/2"x3 1/4" 20NF	1/8	37.79 <b>G-4</b>		
<b>Crank and Cam Grinders</b>	Storm-Vulcan 14, 15, 15A, 15C, 75, 75A	1/2"x3"	3/4	131.29 <b>G-25</b>		
		1/2"x3"	1	179.99 <b>G-25A</b>		
<b>Scledum</b>		10mmx1 5/8"	3/4	132.29 <b>G-27</b>		
		10mmx1 5/8"	1		299.99 <b>G-27AP</b>	
	Winona Van Norman/Zanrosso,	7/16"x1 1/4", 5/8" head	3/4	132.29 <b>G-30</b>		
	Lempco, Landis	7/16"x1 1/4", 5/8" head	1	178.49 <b>G-30A</b>	369.99 <b>G-30AP</b>	
	Berco	tapered, step type	1	179.99 <b>G-32A</b>	299.99 <b>G-32AP</b>	
	Berco	tapered, step type	1 1/2	299.99 <b>G-32B</b>	429.99 <b>G-32BP</b>	
	Storm-Vulcan, WVN CG210, 250, 280	1/2"x2" 70° rad. dress	3/4	224.99 <b>G-33</b>		
	<b>Flywheel Grinder</b>	Kwik-Way 796	7/16"x2"	1/8	36.79 <b>G-6</b>	

## Premium Diamond Resetting Service:

Send in your worn premium diamonds for fast resetting. Prices quoted upon request. Reset when wear facets exceed 1/16" on a 1/2 to 3/4 carat diamond and 1/8" on a 1 carat or larger.

Ship Diamonds to GOODSON | ATTN: RESETTING | 156 GALEWSKI DRIVE | WINONA, MN 55987  
Be sure to include your customer number and contact information.

CYLINDER HEAD REBUILDING  
CLEANING, ASSEMBLY & SAFETY  
SHORT BLOCK REBUILDING  
FLYWHEEL GRINDING  
CRANKSHAFT/GRINDING  
MISCELLANEOUS TOOLS & SUPPLIES  
BRAKE & TIRE CHANGING TOOLS  
MEASURING TOOLS  
V-TWIN & METRIC HARD PARTS



## Deburring Tool

- Swivel tool chamfers sharp, machined edges, bolt holes, and much more
- DT-6 includes cutters for aluminum and cast iron

Description	Jobber	Order No.
Deburring Tool	\$18.79	DT-6
<b>Replacement Cutters</b>		
Steel/Aluminum	\$5.79	DT-10
Cast Iron/Brass	5.79	DT-20

## 14mm Spark Plug Thread Chaser

- Ideal for spark plug hole cleaning
- Re-forms the original material by burnishing, not cutting, and won't create new chips to clean out
- Order No. **SPB-14** Jobber \$72.29



## Burr Buster

- Use on air float tables, seat & guide machines, beds of crankshaft grinders and flywheel grinder tables
- Deburrs gasket surfaces on heads, blocks, manifolds, etc.
- 120 grit premium grade abrasive
- 1½" x 2¾" x 9"
- Order No. **BB-9** Jobber \$23.99



## Bench Grinder Wheels

- 40 and 60 grit for general grinding
- 100 grit for sharpening carbide tools
- Includes bushings to reduce arbor hole from ¾" to ½"
- PLUS a ⅝" bushing adaptor

Size	Grit	Jobber	Order No.
<b>General Purpose Wheels:</b> For steel and cast iron			
6" x ¾"	60	\$18.99	GG-666
6" x 1"	60	22.99	GG-686
7" x 1"	40	22.99	GG-784
8" x 1"	40	29.99	GG-884
8" x 1"	60	27.99	GG-886
<b>Green Grit Wheels:</b> For sharpening carbide tools			
6" x ½"	100	\$29.99	GGC-641
6" x ¾"	100	26.99	GGC-661
6" x 1"	100	32.99	GGC-681

GS-00



GS-0



### Grinding Wheel Star Dressers

Hand dresser for wheels up to 10" dia. \$18.99 **GS-0**

### Replacement Cutter Sets

4 blades, 2 spacers, ¼" ID for GS-0 dresser \$6.99 **GS-00**  
4 blades, 2 spacers, ½" ID for GS-1 dresser 7.99 **GS-11**

## Deburring Wheels for Bench Grinders

- Medium-hard wheels are better suited for heat sensitive materials
- Use to clean and polish white metal
- Buff and Blend Wheels deliver the same results as a wire brush but are much safer to work with

Description	Size	Qty.	Jobber	Order No.
Medium-Hard Deburring Wheel	6" x 1" x 1"	1	\$84.49	SCW-68M
Buff and Blend Wheels	6" x ½" x 1"	5	18.99	BBD-65



## Premium Tapered Reamers For Tie Rods and Ball Joints

- Use by hand or with a powered driver to deburr or enlarge tapered holes for tie-rod ends or ball joints
- Use in ½" chuck at approximately 40 RPM

TR-216-1 TR-216-3 BJR-2



OAL	Flute	Small End	Big End	Taper	Jobber	Order No.
5¾"	3¾" long	⅛" dia.	½" dia.	----	\$ 35.99	TR-216-1
6½"	4½" long	⅞" dia.	1" dia.	1½" per ft.	129.99	TR-216-2
6½"	4½" long	1⅝" dia.	1½" dia.	1½" per ft.	154.99	TR-216-3
5"	3" long	½" dia.	1" dia.	2" per ft.	119.99	BJR-2

## Maxxeon WorkStar™ 220 LED Compact Inspection Light

- 6" inspection light weighs just 1 ounce
- Black anodized T6 aluminum body
- Threaded joints have rubber O-ring seals
- Push-button switch is rated at 100,000 cycles and is sealed to keep out dirt and grit
- Runs on 3-AAAA alkaline batteries (included) up to 4 hours
- Order No. **DFL-220** Jobber \$36.79



Includes all the needed components



## Parts Tumbler Rebuild Parts For Sioux™ 710 Parts Tumbler

Description	Jobber	Order No.
Rebuild Kit	\$249.99	SX-710-KIT
Steel Gear	57.79	271
Fiber Gear	57.79	19275

# Machine Replacement Parts

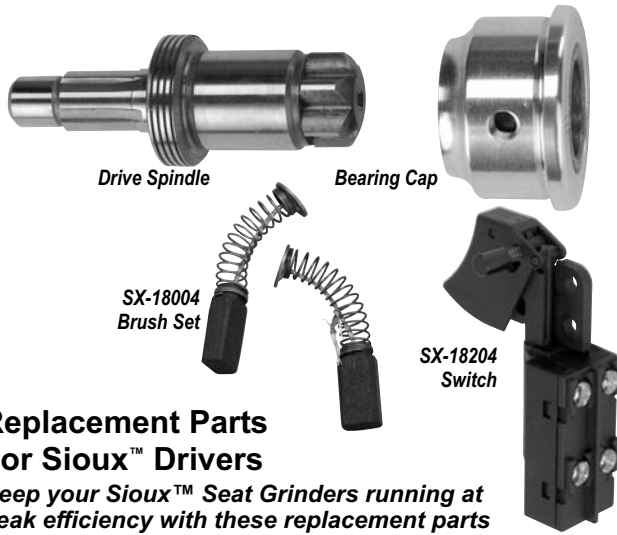

## Replacement Parts For Sioux™ Drivers

Keep your Sioux™ Seat Grinders running at peak efficiency with these replacement parts

- Drive Spindle is spring loaded for dual action grinding
- Brush set is a pair of direct replacement carbon brushes for armature and measures 3/8"x1/2"
- Fit Sioux™ 1710 and 1792 drivers

Description	Jobber	Order No.
Drive Spindle for Sioux™ 1710 Electric	\$84.99	<b>SX-22916</b>
Bearing Cap for Sioux™ 1710 Electric	47.29	<b>SX-23694</b>
Brush Set for Sioux™ 1710 Electric	29.99	<b>SX-18004</b>
Switch for Sioux™ 1710 Electric with plastic handle only	32.49	<b>SX-18204</b>
Drive Spindle for Sioux™ 1792 Pneumatic	84.99	<b>SX-22939</b>
Bearing Cap for Sioux™ 1792 Pneumatic	44.99	<b>SX-33970</b>

Metal handle switch is no longer available



## Replacement Vacuum Tester Parts

- For Sioux™ 1630K Tester which is no longer manufactured
- Closed cell foam for an exceptional seal

### Sioux-Style Replacement Plates for the 1630K Tester

Size	OE No.	Jobber	Order No.
2" / 50.8mm dia.	1630-2	\$26.99	<b>SVT-2</b>
3" / 76.2mm dia.	1630-3	29.99	<b>SVT-3</b>
4.75" / 120.7mm dia.	1630-4	34.99	<b>SVT-475</b>
6" / 152.4mm dia.	1630-6	39.99	<b>SVT-6</b>
2"x3" / 50.8 x76.2mm		27.99	<b>SVT-23</b>
3x4" / 76.2 x101.6mm		31.99	<b>SVT-34</b>

### Replacement Parts for the 1630K Tester

Replacement Fitting	\$13.99	<b>DVC-SX</b>
Replacement Gauge	39.99	<b>1630-GAUGE</b>

More vacuum testing products on page 47

## Pilots & Bushings

- Replacement parts for the popular 1716 Seat Wheel Dresser no longer available from Sioux™
- .375" top pilot features a groove to fit Black & Decker holders

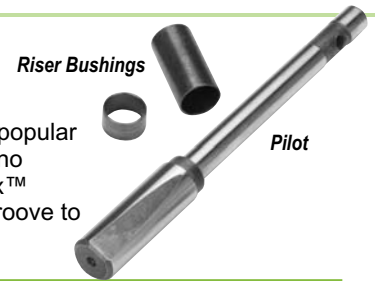

Description	Jobber	Order No.
.385" Top Pilot	\$76.49	<b>1718A</b>
.375" Top Pilot	70.99	<b>1718-BD</b>
.572" Dressing Stand Pilot for Sioux™ 1716 Dresser	76.49	<b>1718-B</b>
Riser Bushings (2) for .385" Pilots	9.99	<b>SK-9-10</b>
Riser Bushings (2) for .572" Pilots	9.99	<b>SK-11-12</b>

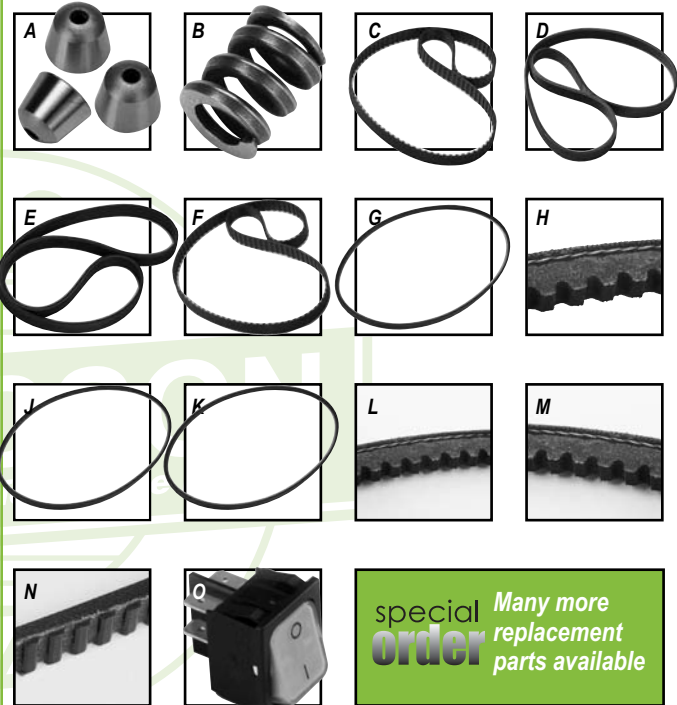

special order Many more replacement parts available

## Replacement Parts for Sioux™ Valve Refacers

Description	Fits Model No.	Jobber	Order No.
A- Chuck Balls (3 pc.)	680, 2075	\$191.99	<b>24185</b>
B- Chuck Springs (9 Pc.)	680, 2075	99.99	<b>SX-53615</b>
C- Cog Style 24"x1/2" 120 teeth	680	27.79	<b>SX-14467</b>
D- Serpentine 29"x1/2" 5 grooves	680	34.99	<b>SX-14471</b>
E- Spindle Belt 28"x1/2" 5 groove	2075	29.99	<b>SX-65117</b>
F- Chuck Belt 23"x3/8", 115 teeth	2075	17.99	<b>SX-14473</b>
G- Replacement Belt for Grinding Head Fits Serial #'s up to 34999(2)	645	49.99	<b>SX-14400</b>
H- Chuck Belt Fits Serial #'s 34999 & up (also coolant pump belt for #'s 35217 & up).	645	19.99	<b>SX-14401</b>
J- Belt for Motor Shaft; Fits Serial #'s up to 34999	645	24.99	<b>SX-14402</b>
K- Coolant Pump Belt; Fits Serial #'s 34999-35216	645	21.99	<b>SX-14403</b>
L- Belt for Motor Shaft; Fits Serial #'s 35000 & up	645	34.99	<b>SX-14445</b>
M- Replacement Belt for Grinding Head; Fits Serial #'s 3500-58700	645	29.99	<b>SX-14453</b>
N- Replacement Belt for Grinding Head; Fits Serial #'s 58701 & up	645	34.99	<b>SX-14461</b>
O- Replacement Switch (1100V, AC)	2001, 2075	56.79	<b>SX-18221</b>



"Be sure to check out the Goodson website (www.goodson.com) for product specials, tech tips, Safety Data Sheets and much more."

- Angie, Advertising Department, 6 years of service

CYLINDER HEAD REBUILDING  
CLEANING, ASSEMBLY & SAFETY  
SHORT BLOCK REBUILDING  
CRANKSHAFT/ FLYWHEEL GRINDING  
MISCELLANEOUS TOOLS & SUPPLIES  
BRAKE & TIRE CHANGING TOOLS  
MEASURING TOOLS  
V-TWIN & METRIC HARD PARTS



**Replacement Parts for CV-616 Honing Machine**

Replacement Belts	Jobber	Order No.
Timing Belt	\$115.49	<b>CK-252</b>
Flat Belt	76.79	<b>CK-192A</b>
"V" Belt, Upper	73.49	<b>CK-209A</b>
"V" Belt, Lower	55.79	<b>CK-498A</b>
"V" Belt, Blower	31.49	<b>CK-1267A</b>
Replacement Gear Set	57.79	<b>CK-234A</b>

Fiber planetary gear set for CV-616 and CK-10 handwheel assembly

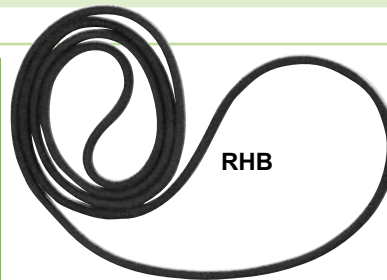

**Goodson Belts for Sunnen® Rod Honing Machines**

- Top-quality belts for long life

**tech tips**  
from the techperis™

You must measure the belt you are replacing. Ordering is based on length not machine model. If your belt size doesn't match one in the chart, order the next size down. For example, if your belt measures 72 1/2", order the 70" Oil Pump Belt. Belts stretch over time so the shorter belt will fit.

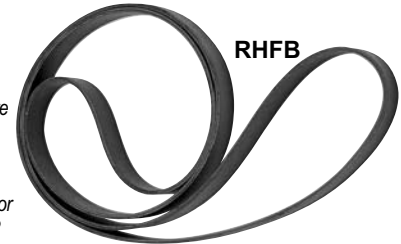

Size	Jobber	Order No.
<b>Oil Pump Belts (round)</b>		
70"/1.78m	\$89.99	<b>RHB-70</b>
74"/1.88m	89.99	<b>RHB-74</b>
79"/2.00m	89.99	<b>RHB-79</b>
84"/2.13m	89.99	<b>RHB-84</b>
85"/2.16m	89.99	<b>RHB-85</b>
109"/2.77m	99.99	<b>RHB-109</b>
<b>Flat Belts</b>		
37 1/4"x3/8"/945.9x15.9mm	\$ 99.99	<b>RHFB-37</b>
45 1/2"x3/8"/1155.7x15.9mm	109.99	<b>RHFB-45</b>
46 1/2"x5/8"/1181.1x15.9mm	109.99	<b>RHFB-46</b>



**Valve Refacer Steady Rest Shoes for Sunnen® VR-7000 & VR-8000**

- Sold by the pair
- Order No **SUN-1202A** Jobber \$69.99

Steady Rest Shoes for Crankshaft Grinders, page 97



**Quick-Mount Bar Set**

- Holds head in place
- Attaches head to roll over cradle
- Fits Goodson Vertical Mill Roll-Over Fixture (pg. 53) as well as many popular seat and guide machines including the Winona PH-2000 and PH-6000
- Order No. **QMB-95** Jobber \$159.99

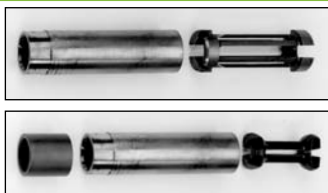

◀ Collet is unavailable from OE

◀ Replace with two-piece set

**Collet for Black & Decker™ Valve Refacers**

- Two-piece set replaces the Black & Decker Twin Grip collet (no longer available)
- Remove the damaged, worn or broken collet and replace with this set
- Accommodates 1/4" (6.35mm) to 3/8" (9.53mm) valve stems
- Order No. **BVR-38** Jobber \$199.99

**Replacement Chuck Belt For Black & Decker**

- Chuck belt for the aluminum housing unit
- Replaces OE V-type belt
- .200" dia. x 12 3/4" long
- Order No. **BVR-B** Jobber \$26.79



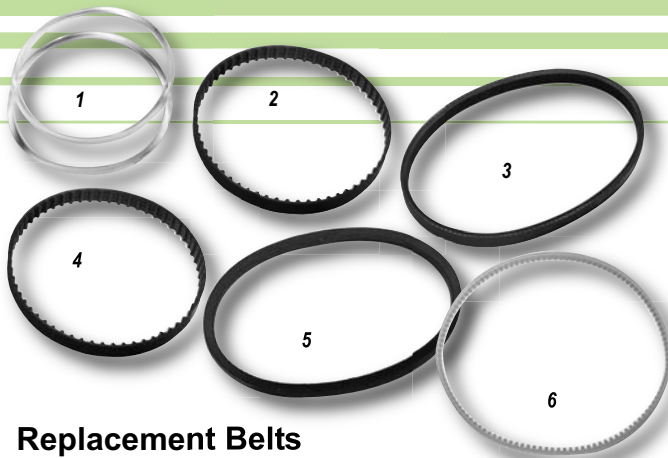

## Replacement Belts For Kwik-Way Valve Refacers

Application	Machine	Jobber	Order No.
1 Spindle Belt 14.5" L "O" Ring - 1 Pr.	SVS II	\$14.49	000-2303-62
2 Chuck Belt 10" Cog, 50 tooth	SVS II	22.29	001-1899-90
3 Spindle Belt 18" Serpentine	SVS	36.79	001-1905-20
4 Chuck Belt 12" Cog, 60 tooth	SVS or VS	22.29	001-1899-99
5 Spindle Belt 16" V-Belt	VS	22.29	001-1900-67
6 Chuck Belt 19" 120 tooth	VS	28.79	001-1900-75

## Replacement Chuck Balls For Kwik-Way Valve Refacers

- Measure chuck ball diameter before ordering to ensure correct replacement
- 6 per set



enlarged to show detail

Diameter	Jobber	Order No.
1/2"	\$41.99	010-2101-27
17/32"	36.79	010-2101-35



**new**

**Rebuild Kits for Kwik-Way**  
For Hex Drive Stone Holder without  
Spring Plunger \$189.99 034-0002-00  
Includes 2 Bearings, Bearing Sleeve,  
Sleeve Key, Bearing Lock Nut, Hex Cap &  
Garter Spring

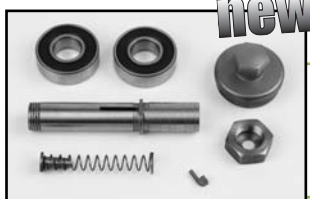

**new**

For Hex Drive Stone Holder with  
Spring Plunger \$199.99 034-0002-15  
Includes 2 Bearings, Bearing Sleeve,  
Sleeve Key, Bearing Lock Nut, Hex Cap &  
Spring Plunger Assembly



**new**

For Flex Drive Stone Holder  
\$199.99 034-0003-25  
Includes 2 Bearings, Bearing Sleeve,  
Heavy Duty Flex Coupling, Inner Sleeve  
Key & Set Screw

## Replacement Trigger Switch

- Fits all Seat Grinding Drivers
- See page 19 for drivers
- Order No. 000-1602-10 Jobber \$21.99



## Automotive Machinist DVDs

Taught by Butch Reilly from Spokane Community College, Easy to understand DVDs are a great addition to any machinist's library.



Title	Run Length	Jobber	Order No.	Incl.
7 DVD Set (one of each below)		\$399.99	DVD-SET	▼
Engine Balancing	138 min.	99.99	DVD-EB	x
Cylinder Honing	46 min.	99.99	DVD-CH	x
Cylinder Boring	52 min.	79.99	DVD-CB	x
Crankshaft Grinding (2 DVD set)	113 min.	99.99	DVD-CG2	x
Using a Micrometer	34 min.	69.29	DMV-1	x
Reconditioning Blocks	64 min.	79.99	DRV-1	x

## Power Building Videos on DVD

The Rotating Assemblies 2-DVD set includes highly detailed, easy to understand information on parts selection and more. The Engine Building 3-DVD set includes a stock Small Block Chevy and a mild performance Small Block Ford.



Description	Length	Jobber	Order No.
Rotating Assemblies	4 hours	\$32.99	DVD-RA2
Engine Building	5 hours	36.99	DVD-EB3

## How to Build and Modify GM LS-Series Engines

This manual includes information on cylinder head preparation, camshafts, rotating assemblies, assembly and induction/nitrous.  
Order No. MA-148 Jobber \$29.99



## Street Rod & Performance Engine Building DVD

- Scott Sehr presents the complete parts selection and assembly of a street rod performance engine
- Order No. ERV-65 Jobber \$59.99



## Basic Engine Building DVD - 2nd Edition

- Step-by-step stock V-8 engine build
- Over 3 hours of footage
- Developed to educate the novice enthusiast as well as assist the advanced builder
- Reference menus include glossary and specialty tools instructions
- Order No. BWV-8 Jobber \$19.99



CYLINDER HEAD REBUILDING  
CLEANING, ASSEMBLY & SAFETY  
SHORT BLOCK REBUILDING  
FLYWHEEL GRINDING  
CRANKSHAFT/ FLYWHEEL GRINDING  
MISCELLANEOUS TOOLS & SUPPLIES  
BRAKE & TIRE CHANGING TOOLS  
MEASURING TOOLS  
V-TWIN & METRIC HARD PARTS

# Brake Lathe Tip Holders

If you're looking for a holder that isn't listed here, call **1-800-533-8010** to see if we can get it for you. All holders include 1 tip.

Machine	Model	Use	OE No.	Jobber	Order No.
Ammco	1000, 2002, 3000, 4000, 4100, 7500, 7700	For Drums 1/2" x 3/8" x 2 1/4"	9872	\$18.99	TAM-41R
All-Tool	747	Use: RT-A series,			
Hoffman	660	negative rake tips			
Performance	6600, 7200, 7100, 7600				
Ammco	3000, 3850, 4000, 4100, 7000 & 6900, 6950 Twin Cutters	For Rotors 3/8" x 3/8" x 1 7/8"	10701	14.99	TAM-701 (R)
Performance	6600, 7200, 7100, 7600	Use: RT-A series,	10702	14.99	TAM-702 (L)
Hoffman	660	negative rake tips			
All-Tool	747				
Ammco	3000, 3850, 4000, 4100, 7000 & 6900, 6950 Twin Cutters	For Rotors 3/8" x 3/8" x 1 7/8"	25968	13.99	TAM-25968 (R)
		Use: RT-3A & RT-3AS series,	25969	13.99	TAM-25969 (L)
		positive rake tips			
Accu-Turn	fits all combination lathes	Drums & Rotors 3/8" x 3/8" x 2 3/4"	433763	14.99	TFM-42R (R)
FMC	600, 601, 700, 701, RotoTruer	Use: RT-AC & RT-FMC series,	433764	14.99	TFM-42L (L)
Hoffman	Perfect 400	positive rake tips			
Bear	1410, 1466, 1467, 1468, 1469, 14781	Drums and Rotors 3/8" x 3/8" x 3"	90495	18.99	TBR-44R (R)
		Use: RT-B series,	90494	18.99	TBR-44L (L)
		negative rake tips			
Ammco	Direction: Left	3/8" x 3/8" x 1 7/8"		27.99	TAM-312L
Hoffman	Direction: Right	3/8" x 3/8" x 1 7/8"		27.99	TAM-312R
Performance, All-Tool		Use: RT-312 series tips			
Ammco	Direction: Left	3/8" x 3/8" x 1 1/8"		26.99	DTAM-312L
Hoffman	Direction: Right	3/8" x 3/8" x 1 7/8"		26.99	DTAM-312R
Performance, All-Tool		Use: RT-64A		87.99	DTAM-SET*
Accu-turn	Direction: Left	3/8" x 3/8" x 2 3/4"		19.99	TFM-312L
FMC, Bear,	Direction: Right	3/8" x 3/8" x 2 3/4"		19.99	TFM-312R
Hoffman, Kwik-Way, Snap-On, etc.		Use: RT-312 series tips			
Accu-turn	Direction: Left	3/8" x 3/8" x 2 1/4"		26.99	DTFM-312L
FMC, Bear,	Direction: Right	3/8" x 3/8" x 2 1/4"		26.99	DTFM-312R
Hoffman, Kwik-Way, Snap-On, etc.		Use: RT-64AC		87.99	DTFM-SET*
Hunter	Set of holders & tips (1 of each)	Use RT-MRH tips		49.99	RT-MRH-SET

\*DTAM-SET & DTFM-SET includes 10 Tips see p. 115

## Measurements for Solid Carbide, Honed Edge Carbide & Titanium Coated Carbide Cutting Tips

**GOODTOOL**  
 Now exclusively from Goodson

### Measure to Find the Right Tip

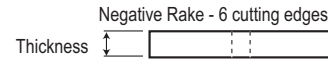
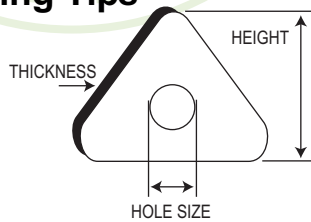
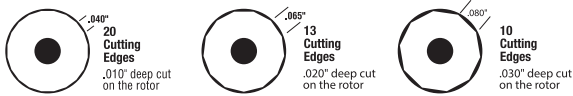

<b>RT-A</b> Height: .350" Thick: .095" Hole: .135" Rake: NEG	<b>RT-3AS</b> Height: .357" Thick: .104" Hole: .127" Rake: POS	<b>RT-3A</b> Height: .343" Thick: .093" Hole: .133" Rake: POS	<b>RT-373</b> Height: .625" Thick: .125" Hole: .117" Rake: POS	<b>RT-AC</b> Height: .445" Thick: .131" Hole: .145" Rake: POS	<b>RT-FMC</b> Height: .452" Thick: .125" Hole: .090" Rake: POS	<b>RT-B</b> Height: .343" Thick: .105" Hole: .130" Rake: NEG
<b>RT-HF</b> Height: .714" Thick: .185" Hole: .200" Rake: NEG	<b>RT-KW</b> Height: .358" Thick: .101" Hole: .125" Rake: POS	<b>RT-H</b> Height: .344" Thick: .125" Hole: .090" Rake: NEG	<b>RT-HNT</b> Height: .312" Thick: .103" Hole: .127" Rake: POS	<b>RT-MRH</b> Diameter: .235" Thick: .125" Hole: .108" Rake: POS	<b>RT-VBG</b> Height: .344" Thick: .098" Hole: .124" Rake: POS	<b>RT-VN</b> Height: .545" Thick: .125" Hole: N/A Rake: POS
<b>RT-VNS</b> Height: .547" Thick: .121" Hole: N/A Rake: POS	<b>RT-VNH</b> Height: .545" Thick: .095" Hole: .135" Rake: NEG	<b>RT-VNA</b> Height: .535" Thick: .188" Hole: .148" Rake: NEG	<b>RT-KWL-T</b> Height: .338" Thick: .100" Hole: .123" Rake: POS	<b>RT-VNP-L OR -R</b> Height: .902" Thick: .100" Hole: N/A Rake: POS	<b>RT-312</b> Diameter: .311" Thick: .100" Hole: .150" Rake: POS	<b>RT-360</b> Height: .311" Thick: .100" Hole: N/A Rake: POS

CYLINDER HEAD REBUILDING  
 CLEANING, ASSEMBLY & SAFETY  
 SHORT BLOCK REBUILDING  
 CRANKSHAFT/ FLYWHEEL GRINDING  
 MISCELLANEOUS TOOLS & SUPPLIES  
 BRAKE & TIRE CHANGING TOOLS  
 MEASURING TOOLS  
 V-TWIN & METRIC HARD PARTS



Tips Are Shown Actual Size

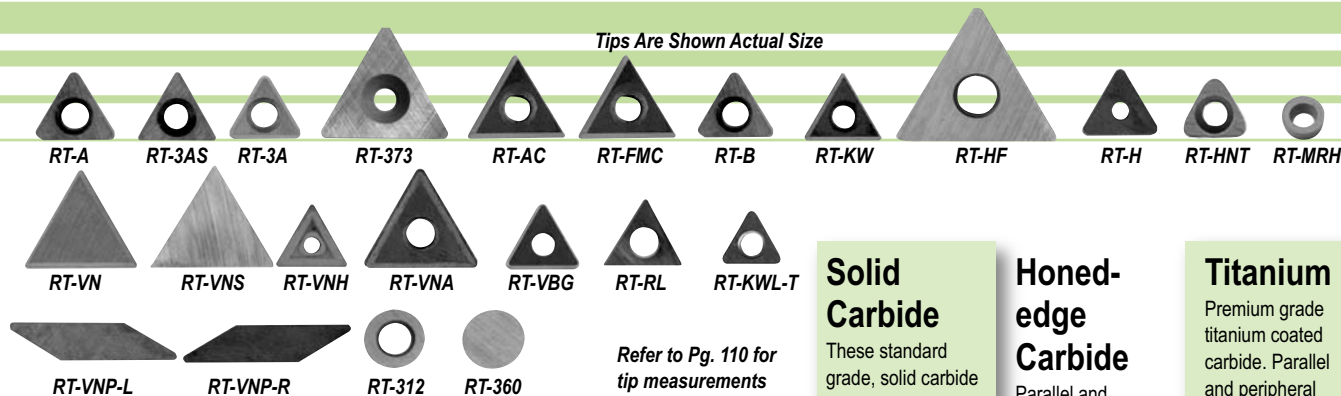

**The more you buy, the more you save!**  
 Order 3 or more 10-packs, save 10% off jobber



Refer to Pg. 110 for tip measurements

### Solid Carbide

These standard grade, solid carbide cutting tips are parallel ground for resurfacing cast iron drums and rotors.

### Honed-edge Carbide

Parallel and peripheral ground. Honed edges deliver a better finish on cast iron and composite rotors.

### Titanium

Premium grade titanium coated carbide. Parallel and peripheral ground for ultimate performance on cast iron & composite rotors.

Machine	Model(s)	OE No.	Edges	Rake	Screw	Jobber	Order No.	Jobber	Order No.	Jobber	Order No.
Ammco	700, 710, OTC Lathes, 1000, 2002, 3000, 4000, 4100, 7000, 7500, 7700	6914	6	Neg	Yes	\$2.79	RT-A	\$2.99	RT-A-H	\$3.59	RT-A-T
	3850 smaller (1/64") radius	6918	3	Pos	Yes	3.99	RT-3AS	4.59	RT-3AS-H	4.99	RT-3AS-T
	larger (1/32") radius	7681	3	Pos	Yes	3.99	RT-3A	4.59	RT-3A-H	4.99	RT-3A-T
Twin Cutters:	6900,6950 negative rake (std.)	6914	6	Neg	Yes	2.79	RT-A	2.99	RT-A-H	3.59	RT-A-T
	positive rake (standard) 1/64" (finer finish)	6918	3	Pos	Yes	3.99	RT-3AS	4.59	RT-3AS-H	4.99	RT-3AS-T
	positive rake (modified) 1/32" (more durable)	7681	3	Pos	Yes	3.99	RT-3A	4.59	RT-3A-H	4.99	RT-3A-T
	7900	6914	6	Neg	Yes	2.79	RT-A	2.99	RT-A-H	3.59	RT-A-T
Ammco HD	5000, 6000, 6002	5677	3	Pos	No	9.79	RT-373				
Accu-Turn	All combination disc/drum lathes	433796	3	Pos	Yes	4.59	RT-AC	4.79	RT-AC-H	4.99	RT-AC-T
	On-The-Car Lathes	878051	6	Neg	Yes	2.79	RT-A	2.99	RT-A-H	3.59	RT-A-T
All-Tool	747	3331	6	Neg	Yes	2.79	RT-A	2.99	RT-A-H	3.59	RT-A-T
Bean	B-401, B-410, B-501, B-601	90487	3	Pos	Yes	3.69	RT-FMC	3.99	RT-FMC-H	4.99	RT-FMC-T
Bear	1410,1466,1467,1468, 1469, 1478	2264,72265,772834	6	Neg	Yes	2.79	RT-B	3.99	RT-B-H		
	10-1430, 10-1435	W136	6	Neg	No	9.79	RT-HF			9.99	RT-HF-T
FMC	600, 601, 700, 701, RotoTruer	90487	3	Pos	Yes	3.69	RT-FMC	3.99	RT-FMC-H	4.99	RT-FMC-T
	505, On-The-Car Lathe	91212	3	Pos	Yes	3.49	RT-KW	3.99	RT-KW-H	4.59	RT-KW-T
Hoffman	660	3331	6	Neg	Yes	2.79	RT-A	2.99	RT-A-H	3.59	RT-A-T
Horvath	All	1605	6	Neg	No	3.99	RT-H				
Hunter	BL300 On-The-Car Lathe	221580-2	6	Neg	Yes	2.79	RT-A	2.99	RT-A-H	3.59	RT-A-T
	BL-500, BL-501, BL-505	6918	3	Pos	Yes	3.99	RT-3AS	4.59	RT-3AS-H	4.99	RT-3AS-T
	BL-500	221-678-3	3	Pos	Yes	4.59	RT-HNT				
Kwik-Way	Micro Tips of OCL-400 Lathe	221-626-3	3	Pos	Yes	7.69	RT-MRH				
	CBL, NCL, SDL Kwik-Lathe OTC Lathe	109-1092-23	3	Pos	Yes	3.49	RT-KW	3.99	RT-KW-H	4.59	RT-KW-T
	Lightening Lathe	109-1092-45	3	Pos	Yes					6.99	RT-KWL-T
Performance	6600,7200,7100, 7600	3331	6	Neg	Yes	2.79	RT-A	2.99	RT-A-H	3.59	RT-A-T
Pro-Cut	On-The-Car Lathe	50-701, 50-742	3	Pos	Yes	3.49	RT-VBG	3.99	RT-VBG-H	4.59	RT-VBG-T
RJ West	915D Disc Lathes	W136	6	Neg	No	9.79	RT-HF			9.99	RT-HF-T
	Perfect 400, 1115HD	W139	3	Pos	Yes	4.59	RT-AC	4.79	RT-AC-H	4.99	RT-AC-T
RTI	BRC35 On-The-Car Lathe	91212	3	Pos	Yes	3.99	RT-3A	4.59	RT-3A-H	4.99	RT-3A-T
Snap-On	YA282, YA277, YA278, YA180 OTC Lathe	109-1092-23	3	Pos	Yes	3.49	RT-KW	3.99	RT-KW-H	4.59	RT-KW-T
Van Norman and Rels	204, 204D, 205, 205DC, 415, 243XV	29687	3	Pos	No	3.99	RT-VN	4.99	RT-VN-H	4.99	RT-VN-T
	Smaller (1/64") radius		3	Pos	No	3.99	RT-VNS	4.79	RT-VNS-H	4.99	RT-VNS-T
	Older Model 204	21933	6	Neg	No	4.99	RT-VNH				
	204, 304, 405	29005	6	Neg	No	6.99	RT-VNA			6.99	RT-VNA-T
	303,304,305,404,405,V22	304-7167	2	Pos	No	6.99	RT-VNP-L			7.99	RT-VNP-LT
	204,205,205DR,300,302,333,243,243XV	302-7167	2	Pos	No	6.99	RT-VNP-R			7.99	RT-VNP-RT
	Rels 2000 rotor	45016, 45021	3	Pos	Yes	5.99	RT-RL				
VBG	On-The-Car Lathe	50-701	3	Pos	Yes	3.49	RT-VBG	3.99	RT-VBG-H	4.59	RT-VBG-T
Round Tips with hole	Fits TAM-312 and TFM-312 Holders	RT-312,RT-312T	360°	Pos	Yes	5.99	RT-312			7.99	RT-312T
	Fits TAM-360SET, solid TFM-360SET, RJH and CT Holders	CT10	360°	Pos	No	5.99	RT-360			7.99	RT-360T

NOTE: The table above shows the original-equipment cutting tips for Ammco machines. Most of them use negative-rake tool systems. However, some Ammco machines (especially the 4000 and 7000-series) have been modified in the field by using the TAM-25968 and TAM-25969 positive-rake tool holders (see next page). If your machine is shown above to have 6-edge tips but has 3-edge tips, it has been modified – please order our RT-3A or RT-3AS series tips.

CYLINDER HEAD REBUILDING  
 CLEANING, ASSEMBLY & SAFETY  
 SHORT BLOCK REBUILDING  
 FLYWHEEL GRINDING  
 CRANKSHAFT/ MISCELLANEOUS TOOLS & SUPPLIES  
 BRAKE & TIRE CHANGING TOOLS  
 MEASURING TOOLS  
 V-TWIN & METRIC HARD PARTS

# Brake Lathe Tools & Silencers

**GOODTOOL**  
Now exclusively from Goodson



## Neoprene Brake Lathe Silencer

- Longer lasting than rubber
- Neoprene material resists deterioration associated with standard rubber belts
- 7 weights
- Measures: 34" L x 5/8" W x 3/16" Thick
- Order No. **GT-6030N** Jobber \$19.99

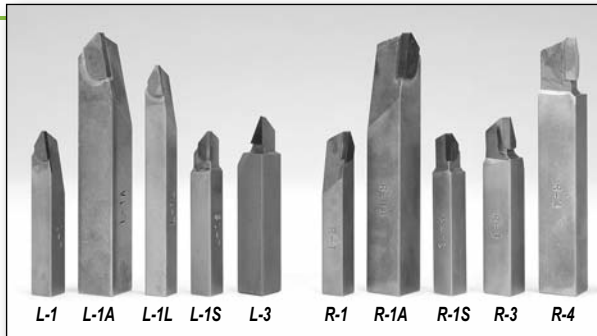

## Brazed Carbide Brake Lathe Tools

- Fit most popular brake drum lathes

### Left Hand Cutting Tools

Size	Application	Jobber	Order No.
3/8" sq. x 2 1/2"	Replaces Bean 43-46L; Bear 23211; Star CB-8; VN 302-7272 for 303, 304, 304H	\$11.99	L-1
5/8" sq. x 4"	Replaces Ammco 5725, for 5000; Star CB-30; VN "Big Brute" for 310-404 Hardspots	19.99	L-1A
3/8" sq. x 3 1/2"	Extra long L-1 for small dia. drums	11.99	L-1L
3/8" sq. x 2 1/2"	Master carbide-tipped with 7° rake angle	14.99	L-1S
1/2" sq. x 2 3/4"	Replaces Ammco 4726 heavy-duty tool Ammco 4726 for 5000 & 6000 dual facing tool & 3000, 4000, 4100 & 7700 lathes	21.99	L-3

### Right Hand Cutting Tools

Size	Application	Jobber	Order No.
3/8" sq. x 2 1/2"	Replaces Bean 43-46R; Bear 20718; Star LB-16; VN 302-7171 for 204, 300, 302, 302H, 333, 243XV; and Barrett & Lempco	\$11.99	R-1
5/8" sq. x 4"	Replaces Ammco 5720 for 5000; Lemppo SHD, DH, 530 Kwik-Way Heavy Duty	19.99	R-1A
3/8" sq. x 2 1/2"	Master carbide-tipped with 7° rake angle	14.99	R-1S
1/2" sq. x 2 3/4"	Replaces Ammco 4725 for 3000, 4000, 4100, 7100 drum lathes	14.99	R-3
5/8" sq. x 4"	Replaces Bear 24034; Star CB-35	18.99	R-4

## Hardspot Cutters

### Left Hand

Size	Use	Jobber	Order No.
3/8"x3/8"x2 1/2"	Drums	\$15.99	L-5
	Discs	15.99	L-6

### Right Hand

Size	Use	Jobber	Order No.
3/8"x3/8"x2 1/2"	Drums	\$14.99	R-5
	Discs	14.99	R-6



L-6 L-5 R-5 R-6



## Silencers For Vented Rotors

Style	Size	OE No.	Jobber	Order No.
Rubber Strap	34"L x 5/8"W x 3/16" thick	6920	\$18.99	CE-8
	36"L x 1 1/4"W x 3/16" thick	6930	32.99	CE-6930
Spring	Fits 6" to 9" rotors		27.99	CE-13
Rubber Tube	9" Diameter, 6 weights		19.99	CE-5
	8" Diameter, 4 weights		19.99	CE-5S

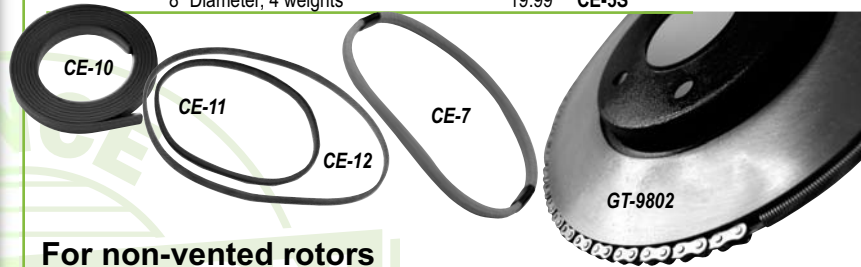

## For non-vented rotors

Style	Size	Jobber	Order No.
Magnetic Strap	48" long	\$ 9.99	CE-10
Rubber Band	6 1/2" dia. x 3/16" W x 3/16" thick	4.99	CE-11
	9 1/4" dia. x 3/16" W x 3/16" thick	4.99	CE-12
Rubber Tube	Fits 6" to 9" rotors	7.99	CE-7
Chain Band	Nickel plated with 4-springs	59.99	GT-9802



## For vented and non-vented rotors

Style	Application	Jobber	Order No.
Clamp-On	For Bench model lathes	\$ 27.99	CE-6
	For On-The-Car lathes	26.29	CE-26
Friction	Most Ammco lathes	157.49	7075
	Replacement Pucks for 7075	14.99	CE-9
	Replacement Mounting Bracket	17.99	GT-10283
	Replacement Wrench	6.99	GT-11497



CE-1, CE-2

## For Drums

Style	Application	Jobber	Order No.	
Rubber Strap	Automobiles	5"L x 2 7/8"W x 1/8" thick	\$16.99	CE-1
	Trucks	6'6"L x 2 7/8"W x 1/8" thick	27.99	CE-2

CYLINDER HEAD REBUILDING  
CLEANING, ASSEMBLY & SAFETY  
SHORT BLOCK REBUILDING  
CRANKSHAFT/ FLYWHEEL GRINDING  
MISCELLANEOUS TOOLS & SUPPLIES  
BRAKE & TIRE CHANGING TOOLS  
MEASURING TOOLS  
V-TWIN & METRIC HARD PARTS

**GOODTOOL**  
Now exclusively from Goodson

### 1" Arbor for Ammco

- Fits Ammco models 2002, 3000, 4000, 4100, 7000, 7500 and 7700
- 7/8" x LH thread
- Precision ground between centers using only one set-up for the greatest accuracy
- Factory checked for runout of less than .001"
- Heat treated, stress relieved tool steel
- For drums and rotors up to 125 lbs.
- Order No. **GT-3101** Jobber \$149.99



### 1" Arbor Accessories

Description	Model(s)	Thread	Jobber	Order No.
Arbor Nuts	Fits all Ammco but 1101	7/8" x 9 LH	\$12.99	<b>GT-3102</b>
	All arbors but Ammco	1" x 8 LH	12.99	<b>GT-20442N</b>
	Fits Hoffman 5389 only	1" x 9 LH	17.99	<b>GT-5389N</b>
Washer	for VN / Rels Arbor		9.99	<b>GT-20442W</b>
Centering Spring			2.99	<b>GT-3110</b>
1" Spacers for ALL Brake Lathes		Length	Jobber	Order No.
		1/2"	\$ 4.99	<b>GT-3125</b>
		1"	12.99	<b>GT-5040</b>
		1 1/2"	13.99	<b>GT-5041</b>
		2"	14.99	<b>GT-5042</b>
	Flexible	26.99	<b>GT-9492</b>	

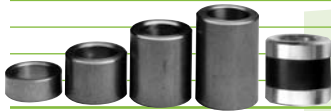

GT-10868



GT-10868X



**GOODTOOL**  
Now exclusively from Goodson

GT-32111



GT-10318

GT-4670



### Ammco Rotor & Drum Feed Screws & Nuts

Description	Jobber	Order No.
Rotor Feed Nut (early)	\$ 25.99	<b>GT-10868</b>
Rotor Feed Nut (late)	25.99	<b>GT-10868X</b>
Drum Feed Nut (all)	43.99	<b>GT-4670</b>
Rotor Feed Screw (4000)	67.99	<b>GT-32111</b>
Rotor Feed Screw (7000)	69.99	<b>GT-10318</b>
Lead Drum Feed Screw (3000, 4000)	121.99	<b>GT-9918</b>



GT-9918

### Replacement Work Light

- 30" adjustable arm lets you position the light exactly where you need it
- 5/8" round mounting end
- Uses up to 100W standard base bulb (not included)
- Easily accessible on/off switch
- Fits most Ammco models
- Order No. **GT-7963** Jobber \$89.99



### 1HP Motor for Ammco Brake Lathes

- Fits 3000, 4000, 4100, 7000, 7500, & 7700 models
- 208/230/115V
- 1725 RPM
- 60Hz
- Order No. **GT-2165** Jobber \$299.99



### Right Angle Drive Assembly for Ammco Brake Lathes

- Fits 3000 & 4000 lathes
- Eliminates radial & axial play
- Order No. **GT-9815** Jobber \$279.99



### Replacement Switch for Ammco Brake Lathes

- Easy to install
- Fits most models
- Order No. **GT-7893** Jobber \$9.99

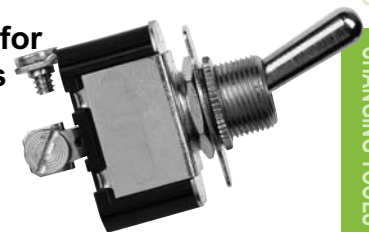

### Brake Shoe Grinding Sleeves

ID	Lgth.	Grit	Application	Jobber	Order No.
3"	3"	100	Fits most models	\$ 2.09	<b>AS-1</b>
3"	5 1/4"	40	Fits most models	5.99	<b>AS-2</b>
3"	6"	40	Fits most models	4.99	<b>AS-3</b>
3"	6 1/2"	40	Fits most models	6.99	<b>AS-4</b>
3"	7 1/2"	40	Fits most models	6.99	<b>AS-6</b>
2 7/8"	4 1/2"	50	Fits Ammco 2007	4.99	<b>AS-7</b>
2 7/8"	4 1/2"	24	Fits Ammco	4.99	<b>AS-7C</b>
4"	6"	24	Shepard-Thompson	7.99	<b>AS-8</b>
4"	8 1/4"	40	Shepard-Thompson	11.99	<b>AS-10</b>
3"	4 1/2"	50	Star	3.99	<b>AS-11</b>

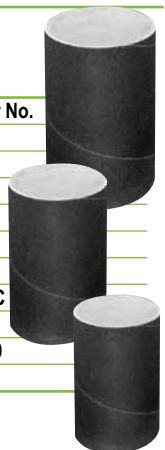

CYLINDER HEAD REBUILDING  
CLEANING, ASSEMBLY & SAFETY  
SHORT BLOCK REBUILDING  
FLYWHEEL GRINDING  
CRANKSHAFT/ MISCELLANEOUS TOOLS & SUPPLIES  
BRAKE & TIRE CHANGING TOOLS  
MEASURING TOOLS  
V-TWIN & METRIC HARD PARTS

# Full Service FAST!



"We pride ourselves on getting orders to our customers quickly. We stock a wide variety of products so that we can get your order to you in 3 days or less."  
 - Brian, Customer Service, 24 years of service

CYLINDER HEAD REBUILDING  
 CLEANING, ASSEMBLY & SAFETY  
 REBUILDING  
 SHORT BLOCK REBUILDING  
 CRANKSHAFT/ FLYWHEEL GRINDING  
 MISCELLANEOUS TOOLS & SUPPLIES  
 BRAKE & TIRE  
 MEASURING TOOLS  
 V-TWIN & METRIC HARD PARTS

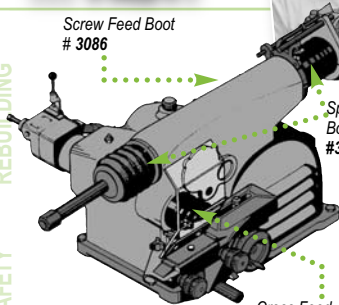

## Replacement Boot Packs

- Keep extra boots on hand for routine maintenance or emergency replacement
- Fits Ammco 3000, 4000, 4100, 7000, 7700

**tech tips**  
 from the techexperts™  
**Rubber is the standard boot material on most brake lathes**



Description	Jobber	Order No.	Incl.	
Neoprene Boot Pack	\$69.99	GT-BOOT-PK		
Rubber Boot Pack	64.99	RSB-BOOT-PK		
Neoprene Spindle Boot Kit	41.99	SBR-KIT		
Rubber Spindle Boot Kit	44.99	RSB-KIT		
Rubber Spindle Boot	19.99	RSB-3085	x	x
Neoprene Spindle Boot	16.79	3085	x	x
Screw Feed Dust Boot	12.79	3086		x x
Cross Feed Dust Boot	12.79	3087		x x
Boot Ring	23.29	23682	x	x x x
C-Clip	2.29	SBR-4435	x	x x x
Snap Ring	3.29	SBR-3159	x	x x x



## Replacement Parts Pack

- Save time – never be caught without one of these essential brake lathe replacement parts again
- Save money – pack price is 10% lower than ordering all parts separately
- Save on shipping – purchasing these parts together costs less in shipping than ordering them individually at different times. You pay shipping and handling one time instead of several
- All parts are also sold separately

Description	Jobber	Order No.	Incl.	
Replacement Parts Pack	\$59.99	GT-PARTS-PK		
Cross Feed Shear Gear	5.29	7996		2
Replacement Locking Knob	2.29	6854		2
Feed Seal	6.29	3163		1
Spindle Seal	8.49	3164		1
Neoprene Spindle Boot	16.79	3085		1
Screw Feed Dust Boot	12.79	3086		1
Cross Feed Dust Boot	12.79	3087		1

## Drive Pulleys & Belts for Ammco

- Fit Ammco 3000, 4000, 4100, 7000 & 7100
- Serpentine design runs quieter and increases arbor speed by 175RPMs
- Virtually eliminates vibration

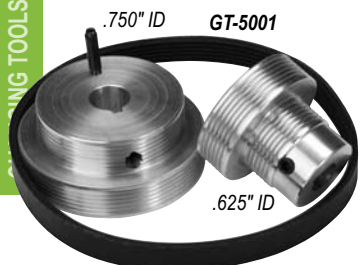

## New-Style (Serpentine)

Description	Jobber	Order No.
Pulley Set (Includes 20 1/4" belt & 2 pulleys)	\$117.99	GT-5001
20 1/4" Belt	19.99	GT-5002
19" Belt	19.99	GT-5003

Install the drive pulley with the pin toward the right angle drive. The two roll-pins drive against each other. A nylon sleeve prevents metal to metal contact.

## Original-Style (V-belt)

Description	Jobber	Order No.
Drive Pulley (Motor)	\$44.99	GT-3024
Driven Pulley (Arbor with drive pin)	79.99	GT-7784-1
25" (replaces OE 3161)	8.99	GT-3161
24" (replaces OE 10241)	8.99	GT-10241

See page 72 for more Flex-Hones®

Order 3 or more Flex-Hones® (mix & match) and save 10% off jobber

## Brake Rotor Flex-Hones®

- Provide a non-directional finish
- Use with a 3/8" variable speed drill at 600-1000 RPM
- Zirconium abrasive
- Use dry

Type	Grit	Jobber	Order No.
Fine	240	\$47.99	BRF-25F
Medium	120	47.99	BRF-25M
Coarse	60	47.99	BRF-25C



Buy all 3 sizes, Save 10% off jobber

## Brake Drum Swedge Cutting Tool

- Hard-to-find tool cuts wheel stud swedges to remove and replace pressed-in wheel studs
- Use with a drill press or mill
- Carbide tipped

Stud Size	Jobber	Order No.
7/16" (.4375")	\$89.99	ST-437
1/2" (.5000")	89.99	ST-500
5/8" (.625")	89.99	ST-562



# Brake Lathe Replacement Parts

## Double Duty Cutting Tip Holders ... Like Getting Two Holders for the Price of One!



### Double Duty Brake Lathe Tip Holders

- Fits popular Ammco, Accu-Turn, FMC and Hoffman brake lathes
- Round holder on one end; triangular holder on the other
- Simply swap ends depending on the job you're performing
- Each holder includes one RT-312T Titanium Cutting Tip (triangular tip sold separately)

Application	Jobber	Order No.	Incl.
Ammco, All-Tool, Hoffman, Performance	\$87.99	DTAM-SET	▼
FMC, Accu-Turn, Hoffman, Kwik-Way, VanNorman	87.99	DTFM-SET	▼
Application	Size		
Ammco, Hoffman, Performance, All-Tool	3/8" x 3/8" x 1 1/8"	Left	\$26.99 DTAM-312L x
		Right	26.99 DTAM-312R x
FMC, Accu-Turn	3/8" x 3/8" x 2 3/4"	Left	26.99 DTFM-312L x
Hoffman 400, Kwik-Way, VanNorman		Right	26.99 DTFM-312R x
Ammco Tips (6-RT-312T, 4-RT-A)			59.99 RT-64A x
Accu-Turn (6-RT-312T, 4-RT-AC)			59.99 RT-64AC x

## Don't buy a new brake lathe - expand your existing one to handle rotors up to 19 1/4"

### Lead Screw Bushing

- Easy installation
- Increases lathe capacity to 15"
- Fits Ammco 3000 and 4000 Brake Lathes
- Order No. **LSB-78529** Jobber \$29.49



### Cross Feed Extension Plate & Stud Assembly

- Fits Ammco models 3000 and 4000 Brake Lathes
- Increases capacity to 17 1/8"
- Order No. **GT-7936** Jobber \$184.99



### Expansion Assemblies for Ammco 4000 & 4100 Lathes

Description	Max. Dia.	Application	Jobber	Order No.	Incl.
Lathe Expansion Set			\$249.99	GT-7935	▼
Lead Screw Bushing	15"	SUVs, Pick-ups	29.49	LSB-78529	x
Cross Feed Extension	17 1/8"	1-ton + Trucks	184.99	GT-7936	x
Lower Guide Bar (extends range by 1 1/2")	19 1/4" L		43.99	GT-70346	x



### Tooling Hold Down Pieces For Ammco

Description	Jobber	Order No.	Incl.
Stud Assembly	\$22.79	GT-25900	▼
6 1/2" Stud	4.99	GT-25913	x
Nut Assembly (must be used with 6 1/2" Stud)	17.99	GT-11227	x
5 1/2" Stud	5.99	GT-3031	
Washers (2)	8.99	GT-3165	

### Rotor & Drum Feed Screws & Nuts For FMC & Bean

Description	Jobber	Order No.
1 Rotor Feed Screw	\$39.99	GT-90071
2 Rotor Feed Nut	34.99	GT-90077
3 Drum Feed Screw	28.99	GT-90667
4 Drum Feed Nut	27.99	GT-1016845



### Brass Wear Inserts For Ammco

Dia. x Lgth.	Jobber	Order No.
3/16" x 1/8"	\$1.99	GT-3141
1 9/64" x 1/4"	1.99	GT-3142
(most popular)		
1/4" x 1 9/64"	1.99	GT-9836



### Replacement Seals For Ammco

Application	Jobber	Order No.
Feed Screw	\$6.29	3163
Spindle	8.49	3164



### Replacement Screw for Twin Cutter Tool Bit Holders

- Square Head Screw
- Order No. **GT-9249** Jobber \$1.29

Buy 5 or more (mix & match 7996 or 6854) and SAVE 10% off jobber!



### Small Ammco Replacement Parts

Description	Jobber	Order No.
Locking Knob	\$2.29	6854
Cross Feed Shear Gear with C-Clip	5.29	7996

## Replace a wall of adaptors

### Quick Chuck Adaptor Replaces a Whole Wall of Adaptors, Centering Cones, Spacers, etc.

- Eliminates mounting problems by self-centering
- Fits hubless rotors and drums, composite rotors and drums
- Fits most foreign and domestic rotors, drums and flywheels, including light trucks with a centering hole from 2 1/8" to 5 3/4"
- Fits all popular 1" arbor brake lathes

Description	Range	Jobber	Order No.	Incl.
Automotive Chuck Adaptor Kit	2 1/8" to 3 3/4"	\$549.99	GT-70040	▼
Truck Chuck Adaptor Kit	2 1/8" to 5 3/4"	829.99	GT-74160	▼
Replacement Automotive Jaws	2 1/8" to 3 3/4"	134.99	GT-70045	
Large Jaw Set	3 3/4" to 5 3/4"	124.99	GT-70041	x
Quick Chuck Adaptor w/Jaws		484.99	GT-70042	x x
Standard Backing Plate, 5.2"OD		139.99	GT-70043	x x
Chuck Key		59.99	GT-70044	x x
Truck Plate (7 1/4" OD)		124.99	GT-70046	x
Small Automotive Plate (4 1/4" OD)		124.99	GT-70047	
Toyota Plate (6 1/4" OD)		129.99	GT-70054	

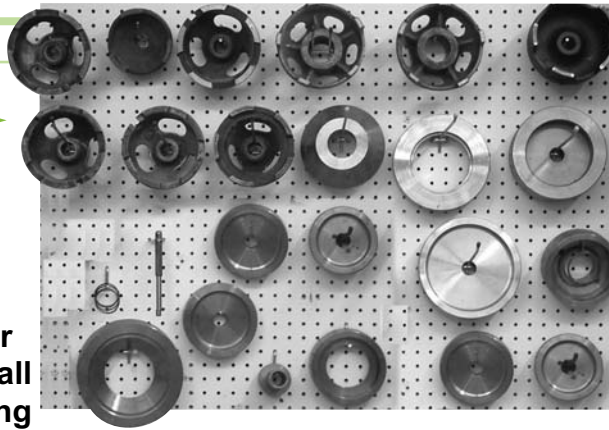

## with the Quick Chuck



Automotive Chuck Adaptor Kit (GT-70040)

Truck Chuck Adaptor Kit (GT-74160)

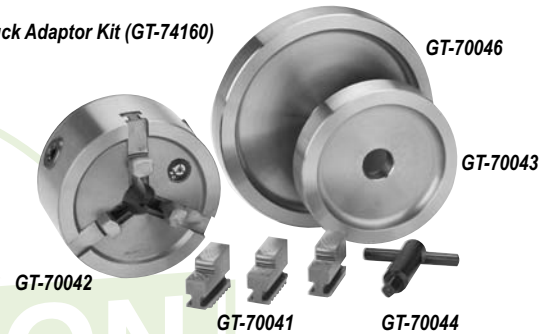

**GOODTOOL**  
Now exclusively from Goodson

Visit [www.goodson.com/technical\\_support/technical\\_library.php](http://www.goodson.com/technical_support/technical_library.php) to see how easy it is to install the Quick Chuck

Buy a case of 12  
(any combination),  
**SAVE 10% off jobber**



**Ceramlub™**  
rated up to  
2800°F

**Pastelub™**  
rated from -  
300°F to 2400°F

## Brake Lubes

These synthetic lubricants will make your brake jobs easier and your customers happier. **Silencer™ Brake Spray** is the backbone of this trio. Use silencer spray on your rotors and other contact surfaces. The revolutionary metalizing treatment is OE approved and is effective from -100°F to +2000°F. **Ceramlub-2800™** contains ceramic pressure solids and anti-corrosive agents. It is specially designed for use on caliper slides, rubber seals and O-Rings.

**Pastelub™** is OE recommended and won't melt, rub or wash off brake parts. It contains no silicone or petroleum. It is recommended for use on the back of brake pads.

Description	Jobber	Order No.	Incl.
Brake Lube TRI-PAK	\$47.99	TMPK-3	▼
Silencer™ Brake Spray (Aerosol)	16.79	BS-12*	1
Ceramlub-2800™ Synthetic Lubricant (Purple)	16.79	CBL-2800	1
Pastelub™ Hi-Temp Lubricant (Gray)	16.79	BPL-2400	1

\*Hazardous Fees Apply When Shipped Air

## Automotive Adaptors for 1" Arbor Brake Lathes



Goodtool Master Tooling Set	Jobber	Order No.	Includes
15 Piece Set	\$449.99	GT-4346	▼
<b>Automotive Bell Clamps for 1" Arbors</b>			
OD Size			
3.625"	\$34.99	GT-9489	x
4.500"	35.99	GT-9490	x
5.750"	39.99	GT-3123	x
<b>Single-Tapered Centering Cones for 1" Arbors</b>			
7-Piece Set	\$179.99	GT-3777	▼
Range			
1.250" - 1.750"	24.99	GT-3902	x x
1.187" - 2.250"	35.99	GT-3903	x x
1.703" - 2.750"	26.99	GT-3904	x x
2.328" - 2.986"	29.99	GT-3108	x x
2.650" - 3.224"	32.99	GT-3178	x x
2.890" - 3.500"	31.99	GT-3107	x x
3.421" - 4.031"	37.99	GT-3106	x x
<b>Double-Tapered Centering Cones for 1" Arbors</b>			
2 Piece Set	\$149.99	GT-9233	▼
5 Piece Set	179.99	GT-9232	▼
Range			
1.322" - 1.670"	33.99	GT-9921	x x
1.362" - 1.710"	36.99	GT-9922	x x
1.711" - 2.073"	39.99	GT-9192	x x
2.074" - 2.440"	41.99	GT-9193	x x
2.441" - 2.897"	46.99	GT-9194	x x
2.828" - 3.185"	79.99	GT-9195	x
3.203" - 3.560"	81.99	GT-9196	x

# Brake Lathe Replacement Parts

**GOODTOOL**  
Now exclusively from Goodson

Replacement Motor for Ammco Lathes on page 113



## Assorted Replacement Parts Keep your Accu-Turn Brake Lathe running in tip-top shape

Description	Jobber	Order No.
1 Rotor Feed Screw Assembly (1/2" 20TPI)	\$ 46.99	GT-433156
2 Drum Feed Screw Assembly (1/2" 13TPI)	45.99	GT-433157
3 Telescoping Way Assembly (fits all except 8989)	189.99	GT-433735
4 Rotor Feed Nut	32.99	GT-433647
5 T-Bolt	13.99	GT-433633
Drum Feed Nut (not shown)	29.99	GT-433646
6 Replacement Variable Speed Switch	219.99	GT-438054
7 Replacement Switch (12 Poles)	69.99	GT-3693

## Replacement Feed Motor For Accu-Turn Brake Lathes

- 1/60 HP • 6 RPM • 120V, 60Hz
- 1.5 Amps • Includes fan
- 2 year limited mfr. warranty
- Ships without blade attached to prevent damage
- For 7700, 8920, 8910, 8911, 8989, 8922
- Order No. **GT-3641**  
Jobber \$169.99

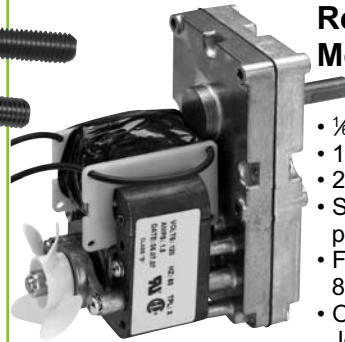

## Variable Speed Replacement Feed Motor For Accu-Turn 8944 & VN V-22 Brake Lathes

- 90 Volt DC Permanent Magnet Gear Motor
- 1/2 HP • RPM F/L: 21 • Torque F/L: 50 in-lbs.
- Ratio: 16:1 • Mounting: Face • 5/16" diameter shaft
- Continuous duty • Sleeve bearings in motor and gearbox
- 2 year limited mfr. warranty
- Order No. **GT-6116** Jobber \$399.99



Large machined  
radius makes  
assembly easy

## Ford F-150 Adaptor

- Machine 2004 & newer Ford F-150 2WD rotors without removing the bearings
- Fast, simple setup means less time spent on mounting the rotor on your lathe
- Two piece kit includes outboard centering drive adaptor and rear centering adaptor
- Approved for late model Ford F-150 two-wheel drive applications with pressed in bearings
- Order No. **FRA-5532** Jobber \$169.99

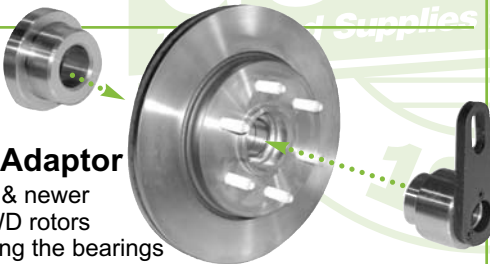

## Late Model Rotor Adaptor

- Turn late model 3/4 & 1-ton rotor assemblies without disassembly • Locates on the rear bearing flange • Mounts to any 1" arbor brake lathe
- One-piece adaptor with four bolts

Description	Jobber	Order No.
Rotor Adaptor	\$139.99	GT-29495
Replacement Bolt Set (4 Pc.)	14.99	GT-29495-SET

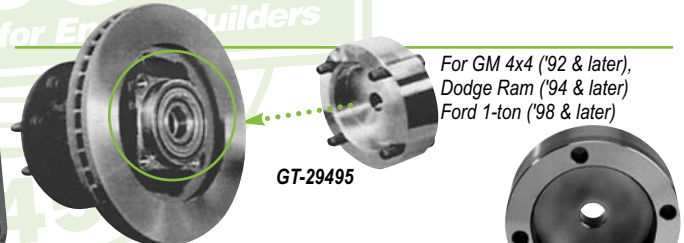

## Captured Rotor Adaptor for 2004 & later Chevy Colorado & GMC Canyon models

- One-piece, self-centering rotor adaptor
- Compatible with all 1" arbor lathes
- Must mount with the adaptor and machined side of the rotor toward the lathe for twin cutter to align properly
- Order No. **CRA-2004** Jobber \$199.99

## Truck Adaptor Sets For 1" Arbors

Description	Jobber	Order No.	Incl.
Standard Truck Set	\$189.99	GT-5062	▼
Master Truck Set	279.99	GT-5060	▼
Centering Cones	3.750" x 5.125"	59.99	GT-5053 1 1
	4.500" x 5.500"	59.99	GT-5052 1 1
	5.000" x 6.125"	84.99	GT-5054 1 1
Bell Clamps	6.500" OD	69.99	GT-5055 1 2
	7.750" OD	79.99	GT-5056 1 1
Heavy-duty Spring	8.99	GT-5059	1 1



CYLINDER HEAD REBUILDING  
CLEANING, ASSEMBLY & SAFETY  
SHORT BLOCK REBUILDING  
FLYWHEEL GRINDING  
CRANKSHAFT/ MISCELLANEOUS TOOLS & SUPPLIES  
BRAKE & TIRE CHANGING TOOLS  
MEASURING TOOLS  
V-TWIN & METRIC HARD PARTS



"It's easy to order from Goodson! Call us toll-free from anywhere in the US or Canada. We're open from 7:30am to 5:30pm Central time, weekdays. You can also fax an order toll-free or order from our website, 24 hours a day, days a week."

- Jon, Ohio Regional Sales Representative, 34 years of service



### Nylon Mount/Demount Head Only

- Hardware not included
- Fits **AccuTurn** (220A OE# SM102529) and **Hunter** (TC350, TC300, TC325 OE# RP6-0340)
- Order No. **TC-03431** Jobber \$22.49



### Nylon Mount/Demount Head

- Hardware included
- Fits **AccuTurn** (3602, 3602HP, 4260, 4560MR, 4602, 5602, 5602HP OE# 20024335); **Hoffman** (1520, 1565, 1620, 1625, 1625EM, 3300, 3300EM, OE# 24335), **John Bean** (EHP System IVE, IV, III, IIE OE# 24335); **Ranger** (980X, may also fit others); **Snap-On** (all models)
- Order No. **TC-140247** Jobber \$79.99



### Replacement Inflator Hoses

- For most popular tire changers

Machine	Length	Hose Dia.	Coupling	Jobber	Order No.
Corghi	60"	1/4"	1/2 MPT x Euro Coupling	\$12.99	TIH-00012
Corghi	60"	1/4"	MPT x Euro Coupling	13.99	TIH-00014
Coats	60"	1/4"	MPT x Euro Coupling	11.99	TIH-00015
FMC	52"	1/4"	Female Swivel Euro Coupling w/guard	17.99	TIH-00020
Hunter	60"	1/4"	1/2" MPT x 1/4" MPT	11.99	TIH-00025
Euro Coupling for Hunter Hose				5.99	TIH-202



### Hold Down Cone for Coats™ Tire Changers

- For center post tire changers
- For center holes up to 6.6" diameter
- Fits models 4040, 4040SA and 4050
- Order No. **GT-108276** Jobber \$54.79



### Nylon Mount/Demount Head

- Hardware not included
- Fits **AccuTurn** (3602, 3602HP, 4260, 4560MR, 4602, 5602, 5602HP OE# 20024335); **Hoffman** (1520, 1565, 1620, 1625, 1625EM, 3300, 3300EM, OE# 24335), **John Bean** (EHP System IVE, IV, III, IIE OE# 24335); **Ranger** (980X, may also fit others); **Snap-On** (all models)

Description	Jobber	Order No.
Standard Grade	\$38.79	TC-20024
Premium Grade High Visibility Yellow	39.99	TC-20042Y



### Stainless Steel Mount/Demount Head

- Hardware included
- Fits **AccuTurn** (3602, 3602HP, 4260, 4560MR, 4602, 5602, 5602HP OE# 20024335); **Hoffman** (1520, 1565, 1620, 1625, 1625EM, 3300, 3300EM, OE# 24335), **John Bean** (EHP System IVE, IV, III, IIE OE# 24335); **Ranger** (980X, may also fit others); **Snap-On** (all models)
- Order No. **TC-26251** Jobber \$149.99

for Engine Builders



### Wheel Balancer Cones

The list below is just a small sampling of the Wheel Balancer Cones that Goodson can supply. Visit us online at [www.goodson.com/Wheel-Balancing-Supplies/](http://www.goodson.com/Wheel-Balancing-Supplies/) for our complete list.

Description	Bore	Jobber	Order No.	Incl.
Wheel Balancer Cone Set	28mm	\$289.99	<b>WBC-2057-28</b>	▼
5.035" - 6.880" Range	36mm	289.99	<b>WBC-2057-36</b>	▼
	38mm	289.99	<b>WBC-2057-38</b>	▼
	40mm	289.99	<b>WBC-2057-40</b>	▼
Wheel Balancer Cone	28mm	149.99	<b>WBC-2059-28</b>	x
	36mm	149.99	<b>WBC-2059-36</b>	x
	38mm	149.99	<b>WBC-2059-38</b>	x
	40mm	149.99	<b>WBC-2059-40</b>	x
7" Spacer/Backing Plate	28mm	139.99	<b>WBC-2058-28</b>	x
	36mm	139.99	<b>WBC-2058-36</b>	x
	38mm	139.99	<b>WBC-2058-38</b>	x
	40mm	139.99	<b>WBC-2058-40</b>	x
Wheel Balancer Cone	28mm	179.99	<b>WBC-2060-28</b>	
5.875" - 7.315" Range	36mm	179.99	<b>WBC-2060-36</b>	
	38mm	179.99	<b>WBC-2060-38</b>	
	40mm	179.99	<b>WBC-2060-40</b>	
Wheel Balancer Cone	28mm	97.99	<b>WBC-29069-28</b>	
3.375" - 5.88" Range	36mm	97.99	<b>WBC-29069-36</b>	
	38mm	97.99	<b>WBC-29069-38</b>	
	40mm	97.99	<b>WBC-29069-40</b>	

Goodson can supply Wheel Balancer Cones from 1.169" - 9.593"

Call for more information



# Tire Changer Mount/Demount Heads

## Mount/Demount Head for Coats



- Includes Hardware
- Fits Model Numbers: 5030, 5040, 5060, 5064, 6050, 6060, 7050, 7055, 7060, 7660, 7665
- Replaces OE 8180361
- Order No. **GT-18306** Jobber \$21.99

## Low Profile Mount/Demount Head for Coats



- Hardware not included
- Features a tapered hole and larger lip and deeper channel than GT-18306 (at left)
- Fits Model Numbers: 5030, 5040, 5060, 5064, 6050, 6060, 7050, 7055, 7060, 7660, 7665 • Replaces OE 184432
- Order No. **TC-84432** Jobber \$31.29

## Nylon Mount/Demount Head with Round Hole



- Hardware not included
- Fits **All Tool** (all models OE# G3008403; **Coats** (RC1, RC5, RC 10, RC15, RC20, Early 5060, 9010, 9024e, APX90 OE# 83008403) **Corghi** (all rim clamp models OE# 450310), **Hoffman** (all except 1550, 1620, 1625 OE# 8314813), **Hunter** (TCX Series (adaptor required), TCX5000 (requires upgrade & adaptor) OE# RP11-8314813), **Sice** M39, S40, S41, S43, S408MAXI, S435, S436, S436TOP OE# 8314813)

Description	Jobber	Order No.
Standard Grade	\$32.99	<b>TC-45031</b>
Premium Grade High Visibility Yellow	39.99	<b>TC-45031Y</b>

## Nylon Mount/Demount Head



- Hardware included
- Fits **All Tool** (all models OE# G3008403; **Coats** (RC1, RC5, RC 10, RC15, RC20, Early 5060, 9010, 9024e, APX90 OE# 83008403) **Corghi** (all rim clamp models OE# 450310), **Hoffman** (all except 1550, 1620, 1625 OE# 8314813), **Hunter** (TCX Series (adaptor required), TCX5000 (requires upgrade & adaptor) OE# RP11-8314813), **Sice** M39, S40, S41, S43, S408MAXI, S435, S436, S436TOP OE# 8314813)
- Order No. **TC-25030** Jobber \$79.99

**new**

## Tire Changer Replacement Wear Parts



### Mount/Demount Head

- For Hunter
- Order No. **TC-14120** Jobber \$39.99



### Duck Head Inserts

- For FMC, Hoffman and Corghi
- 10 pieces per pack
- Order No. **TC-24715** Jobber \$19.99



### Duck Head Inserts

- For Accu Turn
- 10 pieces per pack
- Order No. **TC-247G15A** Jobber \$35.99



### Duck Head Inserts & Rollers

- For AccuTurn
- 4 pieces per set
- Order No. **TC-24016079** Jobber \$19.99



### Quilted Sock/Jaw Protectors

- For Coats
- 10 pieces per pack
- Order No. **TC-183604** Jobber \$39.99



### Duck Head Inserts

- For Hunter Stainless Steel Duck Head
- 10 per package
- Order No. **TC-11400096** Jobber \$34.99



### Rim Protectors

- For Coats
- 12 pieces per pack
- Order No. **TC-182963** Jobber \$20.99



### Rim Protectors

- For Sicam & AccuTurn
- 5 pieces per pack
- Order No. **TC-101608** Jobber \$23.99



### Jaw Covers

- For Sicam
- 4 pieces per pack
- Order No. **TC-141402** Jobber \$22.99



### Jaw Protectors

- For AccuTurn, Coats and Corghi
- 4 pieces per set
- Order No. **TC-24720** Jobber \$23.99

Visit [www.goodson.com](http://www.goodson.com) for additional information and to see our full listing of tire changer parts

CYLINDER HEAD REBUILDING  
CLEANING, ASSEMBLY & SAFETY  
SHORT BLOCK REBUILDING  
FLYWHEEL GRINDING  
CRANKSHAFT/ FLYWHEEL GRINDING  
MISCELLANEOUS TOOLS & SUPPLIES  
BRAKE & TIRE CHANGING TOOLS  
MEASURING TOOLS  
V-TWIN & METRIC HARD PARTS

CYLINDER HEAD REBUILDING  
CLEANING, ASSEMBLY & SAFETY  
SHORT BLOCK REBUILDING  
CRANKSHAFT/ FLYWHEEL GRINDING  
MISCELLANEOUS TOOLS & SUPPLIES  
BRAKE & TIRE CHANGING TOOLS  
MEASURING TOOLS  
V-TWIN & METRIC HARD PARTS



### 6" Direct Reading Dial Caliper

- Four way measurement - outside, inside, depth and step
- Hardened stainless steel with satin chrome finish
- Precision ground and lapped measuring surfaces
- Reads direct to .001" or with .100" graduations on beam
- Adjustable bezel with lock
- Thumb roll with lock
- 1 1/16" jaw length
- Large easy to read dial
- Covered rack
- Fitted case • Order No. **MDC-03** Jobber \$59.99

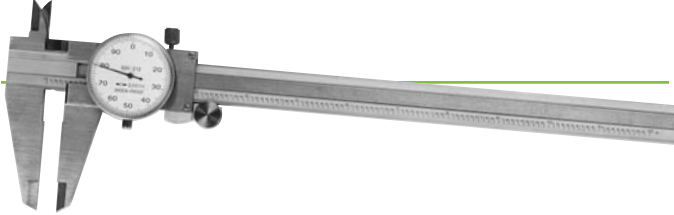

### 12" Direct Reading Dial Caliper

- .001" single revolution • Hardened measuring face
- Precision Ground • Micro-lapped for accuracy
- Adjusting slide for fine adjustment
- Take Inside, Outside and Depth measurements
- Satin Chrome finish with engraved graduations
- Clamp for repetitive readings
- Accurate to .001" per 6"
- Covered Rack • Deluxe case
- Order No. **EDC-12** Jobber \$104.99



### 6" Digital Caliper

- Accuracy: .0008" under 4" length / .0012" over 4" length
- .0005" (.01mm) resolution
- Automatic floating zero
- Take Inside and Outside measurements
- Direct inch/metric Conversion
- Large, high-contrast LCD display
- On/Off Button • Storage case

Description	Jobber	Order No.
Digital Caliper	\$54.99	EEDC-06
Replacement Battery	4.99	EDC-06B

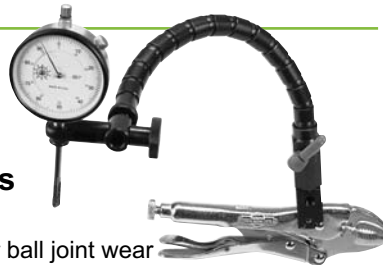

### Dial Indicator Set with Locking Pliers and Flexible Arm

- Measure rotor runout or ball joint wear
- Flexible arm can be locked into almost any position
- Unit includes: flexible arm, dial indicator (0"-1"), curved jaw locking pliers and case

Description	Jobber	Order No.
Economy Disc Rotor & Ball Joint Gauge	\$136.49	DIS-103
Replacement Dial Indicator	27.99	EDI-1

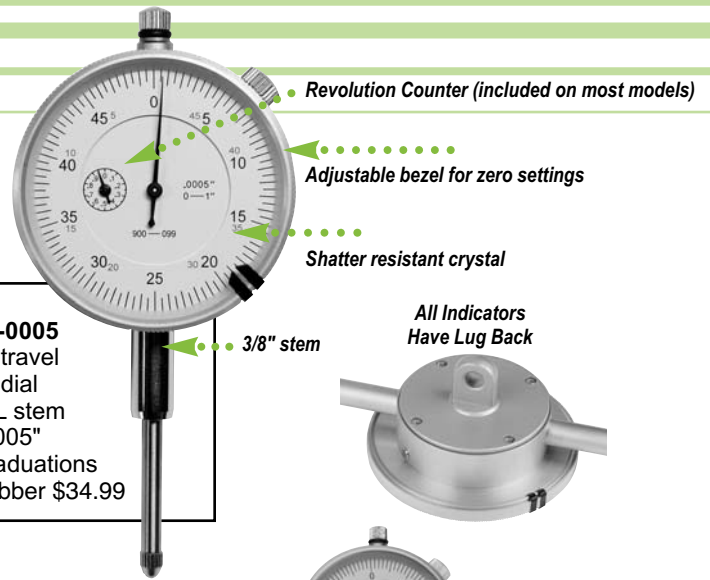

- EDI-0005**
- 1" travel
  - 2" dial
  - 1"L stem
  - .0005" graduations
  - Jobber \$34.99

• Revolution Counter (included on most models)

Adjustable bezel for zero settings

Shatter resistant crystal

All Indicators Have Lug Back



- EDI-1**
- 1" travel • 2" dial
  - 1"L stem
  - .001" graduations
  - Jobber \$27.99

- MDI-12**
- .125" travel
  - 2" dial
  - 12"L stem
  - .001" graduations
  - Jobber \$359.99



- MDI-110**
- .050" travel
  - 2" dial
  - 1"L stem
  - .0001" graduations
  - Jobber \$69.99



- MDI-2**
- 2" travel • 3" dial
  - 2"L stem
  - .001" graduations
  - Jobber \$59.99



### Metric Dial Indicator & Accessories

Now you can use your metric dial indicator with standard spindle extensions! The Metric Dial Indicator Point Adaptor mounts to your dial indicator to convert its threads from 2.25mm to 2x48 TPI.

Description	Jobber	Order No.
Metric Dial Indicator	\$159.99	MDI-25MM
Metric Dial Indicator Point Adaptor	26.79	DIS-MTE
Spindle Extensions		
1 1/2"	7.99	DIS-1.5
2 1/2"	10.49	DIS-2.5
3"	15.79	DIS-3.0



## Metric Micrometer Set

- Complete set covers a range from 0 to 100mm in 25mm increments
- Graduations: 0.01mm • Carbide measuring faces
- Ratchet thimble and locking nut
- Includes 4 micrometers, 3 standards and storage case
- Order No. **MMS-100** Jobber \$179.99

## Premium Micrometers

- Precision ground carbide anvil parallel to within .0005"
- .0001" graduations
- Set includes wood storage case

Description	Range	Jobber	Order No.	Incl.
<b>Economy Micrometer Set</b> (wood storage case)		\$229.99	<b>EMS-06</b>	▼
<b>Individual Micrometers</b>	0"-1"	34.79	<b>EMIC-01</b>	x
	1"-2"	38.29	<b>EMIC-12</b>	x
Each micrometer	2"-3"	42.79	<b>EMIC-23</b>	x
includes a standard,	3"-4"	46.29	<b>EMIC-34</b>	x
spanner wrench & case	4"-5"	54.99	<b>EMIC-45</b>	x
	5"-6"	57.99	<b>EMIC-56</b>	x

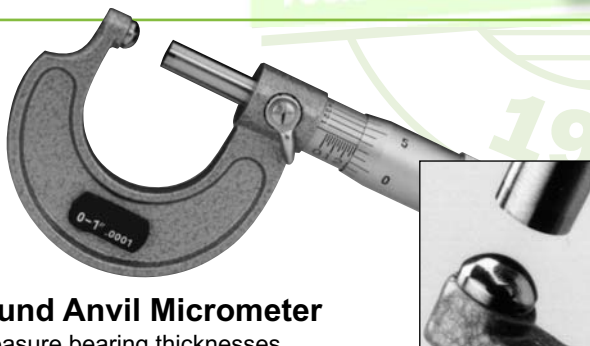

## Round Anvil Micrometer

- Measure bearing thicknesses
- Ratchet spindle • 0-1" range • Precise to .0001"
- Order No **MIC-01-B** Jobber \$99.99

## Mitutoyo Small Hole Gauge Set

- See if rebuilding or replacement is needed by checking actual guide wear
- Check guide bosses for proper interference fit during replacement
- Check and maintain correct stem to guide ID clearance
- 4-piece set has combined range of .125"-.500" / 3.2-12.7mm
- Storage case included
- Order No. **SHG-5** Jobber \$129.99



Open and close the padded jaws to accommodate most micrometers and dial bore gauges

Easy to reach knob adjusts the head angle

## Micrometer Stand

- Heavy cast iron construction
- Use to hold micrometers, standards or just about anything you need an extra hand for
- Swivel head and padded jaws won't damage expensive measuring tools
- Order No. **MIC-FIX** Jobber \$21.99

## Use the Micrometer Stand When Setting Your Dial Bore Gauge

Read more about it on our blog (<http://www.goodson.com/blog/2013/07/31/tips-and-tricks-for-setting-a-dial-bore-gauge/>). Scan the code at right to go to the blog.

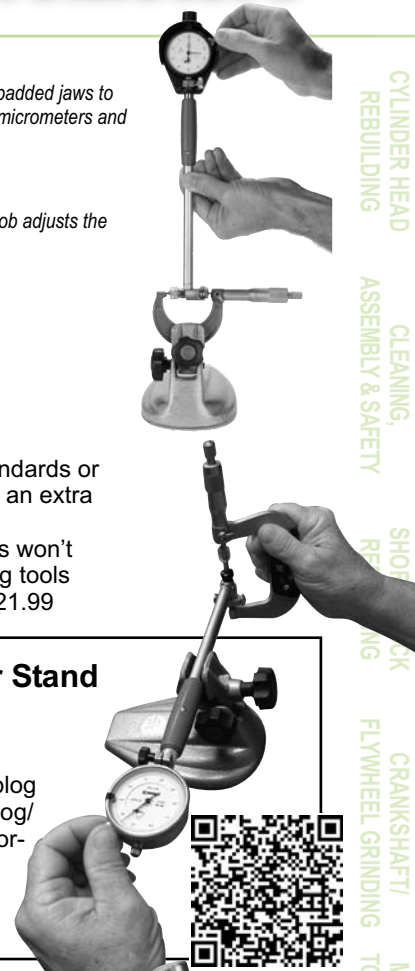

## Checking Standards

- Use to set up dial indicators in special application gauging and to check micrometer accuracy
- Made of hardened, ground and lapped tool-steel
- Meet or exceed federal accuracy specifications

Length	Jobber	Order No.
1"	\$9.99	<b>MCS-1</b>
2"	9.99	<b>MCS-2</b>
3"	9.99	<b>MCS-3</b>



## Valve Seat Run-Out Gauge

- Measure run-out to .001"
- Hardened guide bushings and contact pilot
- Quick thumb screw set-up
- Jeweled bearing indicator reads to  $\pm 0.050$ " with .001" precision
- Range: 1.00" - 2.50"

Pilot Size	Jobber	Order No.
.375" / 9.53mm	\$149.99	<b>VSG-375</b>
.385" / 9.78mm	149.99	<b>VSG-385</b>



CYLINDER HEAD REBUILDING  
CLEANING, ASSEMBLY & SAFETY  
SHOCK  
CRANKSHAFT/  
FLYWHEEL GRINDING  
MISCELLANEOUS TOOLS & SUPPLIES  
BRAKE & TIRE CHANGING TOOLS  
MEASURING TOOLS  
V-TWIN & METRIC HARD PARTS



"If you need engine building tools and supplies, you need Goodson! We're dedicated to providing you with the best quality products, the best value and the best service in the industry."

- Matt, Receiving - 10 years of service

CYLINDER HEAD REBUILDING  
CLEANING, ASSEMBLY & SAFETY  
SHORT BLOCK REBUILDING  
CRANKSHAFT/ FLYWHEEL GRINDING  
MISCELLANEOUS TOOLS & SUPPLIES  
BRAKE & TIRE CHANGING TOOLS  
MEASURING TOOLS  
V-TWIN & METRIC HARD PARTS

**Goodson  
exclusive**

### Dial Bore Gauge Setting Fixture

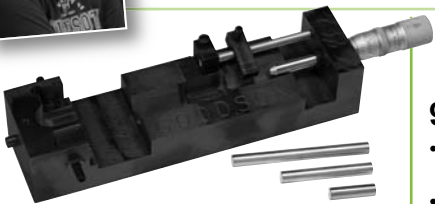

- Fast, accurate setting from 2" to 6"
- Billet steel construction with a tool black finish
- Sets most popular bore gauges including Mitutoyo™, Phase II, Fowler and Peacock • Will not fit Sunnen Bore Gauges (see page 135 for Sunnen setting fixture)
- .001" increment micrometer • 3 setting standards (1", 2" & 3") included • Carrying case included
- Order No. **DBG-FIX** Jobber \$493.49

### 90° Dial Bore Gauges

- Measure cam bores, main bores and other hard-to-reach areas directly
- No passing through other bores to measure inboard journals • .100" travel in .0001" increments
- Metric has 3mm travel in .01mm resolution
- 3 spacers, 11 probes and case included



Range	Graduations	Jobber	Order No.
2.0" - 6.0"	.0001" .0025mm	\$349.99	<b>MCB-90</b>
50-160mm	.01mm	209.99	<b>DMBG-50160</b>

### Cylinder Dial Bore Gauge Sets

- Easy to read • Insulated grip
- Measure cylinders up to 9" deep
- Graduations: 0.0005" • Self-centering
- Chrome plated handle
- Includes extension holder and fitted case



Range	Jobber	Order No.
0.7" - 1.4" (18-35.6mm)	\$139.99	<b>FBG-7</b>
1.4" - 6.0" (35-150mm)	159.99	<b>FBG-146</b>



### Economy Bore Gauges

- Includes: .050" travel indicator, 3 spacers (.100", .050" and .020"), probes and case

Description	Range	Probes	Resolution	Jobber	Order No.
Standard US	2" - 6"	11	.0005"	\$119.99	<b>EBG-265</b>
Standard US	2" - 6"	11	.0001"	189.99	<b>EBG-261</b>
Metric	35 - 160mm	12	.01mm	169.99	<b>MCBG-160</b>
11 Pc. Replacement Spacer Set				29.99	<b>EBG-ANVILS</b>



### Dial Bore Gauge Set

- Rugged bore gauge with protected dial
- Carbide tipped contact points
- .0001" (.001mm) graduations • Indication stability: .00008"
- Accuracy: .0002" • Shoe can be rotated for a fresh wear surface • Sets up with a standard micrometer (see page 121)

Range	Description	Jobber	Order No.
2.0"-6.0"	11 anvils and 4 spacers	\$524.99	<b>MCCB-06</b>
	Replacement Spacers for anvils 2" & larger	.020" 9.79	<b>MCCB-06-020</b>
		.040" 9.79	<b>MCCB-06-040</b>
		.080" 9.79	<b>MCCB-06-080</b>
		.120" 9.79	<b>MCCB-06-120</b>
	Replacement Lens	20.79	<b>MCCB-06LENS</b>
	Replacement Dial Indicator	204.29	<b>MCCB-06IND</b>
	Replacement Dial Cover	26.29	<b>MCCB-06COVER</b>

### Internal Electronic Caliper

- Ideal for measuring, mating port runners and bowl measurements • Hardened contact surfaces
- Robust housing with large LCD display
- Range: 0.5" to 6.0" • Reading: .01"/.3mm/1/64ths
- Spring loaded locking nut
- Order No. **IEC-56** Jobber \$52.49



### Teak Bore Gauge Stand

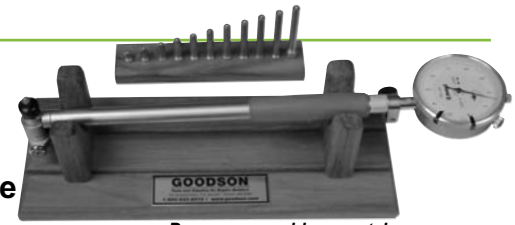

*Bore gauge sold separately*

You'll always be able to find your bore gauge when you store it on this solid teak stand. The organizer rack is designed to keep your anvils organized and protected and is included with the rack. Handcrafted by Goodson's sister company, Teakworks4u.

Description	Jobber	Order No.
Sunnen® Bore Gauge Stand	\$14.99	<b>BGS-1S</b>
Universal Bore Gauge Stand	14.99	<b>BGS-1</b>

# Measuring Tools



Dial indicators sold separately

## Deck Bridge Tools

- Verify deck height without removing block from roll over fixture
- Flat anvil surface makes full contact
- Use Deck Bridge with either 1 or 2 dial indicators

Description	Jobber	Order No.
Deck Bridge (4½" span)	\$ 84.99	MDBS-2
Dial Indicator (12" OAL)	359.99	MDI-12
Dial Indicator Flat Anvil	21.99	MDI-12A
Economy Dial Indicator	27.99	EDI-1



## Valve Seat Height Gauge

- Confirm seat height to fire deck location
- Adjusts for all popular seat diameters
- Accurate to .001"
- Seat contact probe aligns on valve seat while gauge rides along the fire deck
- Pilot aligns in valve guide
- Adjustable to fit popular seat diameters from .750" to 3.00"

Description	Fits Pilot	Jobber	Order No.
Valve Seat Height Gauge Kit	.375"	\$94.99	VSHG-375
Replacement Dial Indicator		27.99	EDI-1



## Leak-Down Tester

- Apply air pressure in spark plug hole
- Compare supply psi to cylinder psi
- Includes 14mm & 18mm adaptors

Description	Jobber	Order No.
Leak Down Tester	\$99.99	LDT-50
Replacement Hose	25.29	LDT-HOSE
10mm Adaptor	12.79	LDT-10MM
12mm Adaptor	12.79	LDT-12MM

**Tech Tips** Listen to where air is leaking. Leakage at the carburetor indicates bad intake valves. Leakage at the tail pipe shows bad exhaust valves. Worn rings or cylinders are indicated by leakage at the dipstick while leakage at the radiator cap points to block problems.

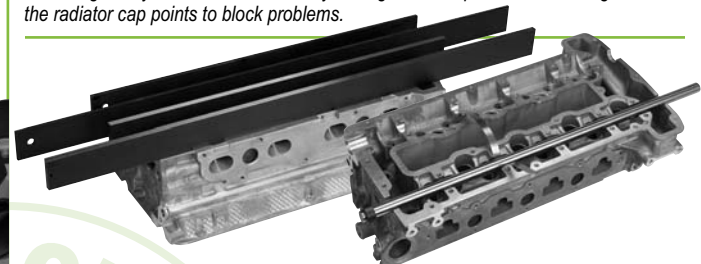

## Precision Straight Edges & Warp Gauge

Description	Jobber	Order No.
24" straightedge, 1 precision edge	\$ 74.99	PSE-24
36" straightedge, 1 precision edge	94.99	PSE-100
24" straightedge, 2 precision edges	162.79	DIS-20
35" straightedge, 2 precision edges	176.49	DIS-30
26" Round Warp Gauge ¾" dia. tool steel, 26" long	139.99	EWG-100

## Universal Magnetic Base Holders

- Fit any type of dial indicator
- Magnetic base features an on-off switch with magnetic pull of 90 pounds
- ¾" diameter 7" high vertical column
- 2" x 2½" x 2¼" base
- Available with or without Fine Adjustment Feature

Description	Jobber	Order No.
Universal Magnetic Base Holder	\$39.99	MBR-1
Universal Magnetic Base Holder with Fine Adjustment	39.99	MBR-1F

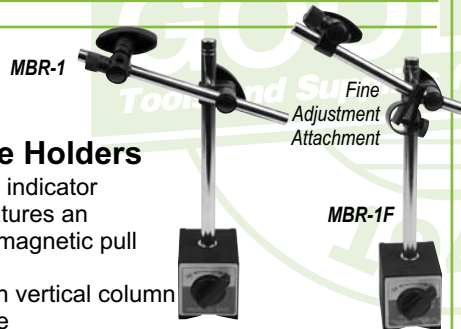

## 12" Feeler Gauges

- Use to measure piston-to-wall clearance when honing, to find ring end gap and to check cylinder heads with a straight-edge
- Also useful for shimming while straightening heads and for machine set-ups

	Jobber	Order No.	Incl.
<b>Complete Kit</b>	\$39.99	FE-KIT	▼
<b>Thick</b> .0015"	5.99	FE-0015	x
.0020"	5.99	FE-002	x
.0030"	5.99	FE-003	x
.0040"	5.99	FE-004	x
.0050"	5.99	FE-005	x
.0060"	5.99	FE-006	x
.0070"	5.99	FE-007	x
.0080"	5.99	FE-008	x
.0090"	5.99	FE-009	x
.0100"	5.99	FE-010	x
.0150"	5.99	FE-015	x
.0200"	5.99	FE-020	x

## Magnetic Mounting Base With 13" Flexible Arm

- Adjusts easily and locks tightly in any position
- 150 pounds of magnetic force
- Locks in place with a single lever
- Order No. **MFB-1** Jobber \$129.99



## 6 Pc. Telescoping Gauge Set

- Compress spring plunger and lock by twisting handle
- Insert into bore and release plunger – it will expand to fit
- Lock again and remove
- Measure with a micrometer
- Double plunger design for consistent measuring
- Long-lasting finish
- Size range: ¼" - 6"
- Order No. **MTG-6** Jobber \$129.99



**American Made**

CYLINDER HEAD REBUILDING  
CLEANING, ASSEMBLY & SAFETY  
SHORT BLOCK REBUILDING  
FLYWHEEL GRINDING  
CRANKSHAFT/ FLYWHEEL GRINDING  
MISCELLANEOUS TOOLS & SUPPLIES  
BRAKE & TIRE CHANGING TOOLS  
MEASURING TOOLS  
V-TWIN & METRIC HARD PARTS

CYLINDER HEAD REBUILDING  
CLEANING, ASSEMBLY & SAFETY  
SHORT BLOCK REBUILDING  
CRANKSHAFT/ FLYWHEEL GRINDING  
MISCELLANEOUS TOOLS & SUPPLIES  
BRAKE & TIRE CHANGING TOOLS  
MEASURING TOOLS  
VTWIN & METRIC HARD PARTS



### GOODSON Replacement Gauge For AG-300

- Reads in .001" increments
- Order No. **AG-GAUGE** Jobber \$89.99

### Sunnen® AG-Series Precision Gauge

- Dial reads directly in "tenths" (.0001")
- Checks rod journal bore for distortion
- Measures size instantly
- Wear-compensated gauge points assure permanent accuracy
- Rugged construction – all moving parts are enclosed in the housing
- Includes Point Sets listed below (optional point sets available, call for information)
- Replacement Gauge swaps easily with the original



Description	Jobber	Order No.
.375" - 3.375" (9.5 - 85.7mm) Range Gauge	\$2,999.99	<b>AG-300</b>
Standard Point Set (.720" - 1.530" Range)	56.79	<b>AG-210</b>
Medium Point Set (1.50" - 2.25" Range)	84.99	<b>AG-620</b>
Large Point Set (1.932" - 2.687" Range)	84.99	<b>AG-630</b>
Replacement Gauge (not OE Sunnen) Reads in .001"	89.99	<b>AG-GAUGE</b>

*Point sets will NOT fit AG-gauges lower than Serial No. 4000*



### Setting Fixture

- Use with GA-2121, GA-2125, GR-2241 and GR-2245 Dial Bore Gauges (below)
- For 2" to 6" diameters
- Incorporates a tenth-reading micrometer head with precision carbide anvil
- Ring gauge checking standard included
- Precision standards in 1" increments
- Setting master has rugged, stress-relieved, cast iron base
- May be used without removing from protective case
- Order No. **CF-1126** Jobber \$1,699.99

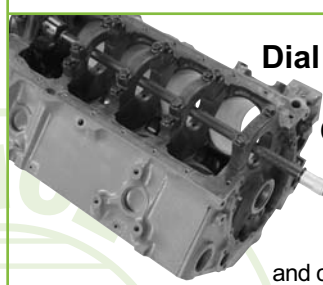

### Dial Bore Gauges with Retractable Centralizers



- Retractable self-centering gauging head mechanism
- Ideal for measuring bores typical of main bearing saddle and camshaft bearing bores
- Diameter range: 2" to 6" • 24" reach

Bore Gauge with Retractable Centralizers	Jobber	Order No.
.0001" graduations	\$1,149.99	<b>GR-2241</b>
.0005" graduations	1,149.99	<b>GR-2245</b>

### Rod Bolt Stretch Gauge

- Accurate to .001"
- Features a 1½" dial gauge
- Heavy-duty tension spring for repeatable accuracy
- For bolts from 1" to 2½" long



ERBG-3T

Description	Jobber	Order No.
Rod Bolt Stretch Gauge	\$79.99	<b>RBSG-3</b>
Optional Contact Point	8.49	<b>ERBG-3T</b>

### tech tips

Most engine rod failures aren't from faulty parts, they're from improper installation. When you're installing the

rods, you need to check the rod bolt stretch by performing a series of torquing and loosening and recording the readings.

Here's how:

1. Torque the bolts to 15 foot pounds and measure the stretch. Record the reading, then loosen the bolts.
2. Repeat at 15 foot pounds and record the reading.
3. Repeat, increasing to 30 foot pounds, record the reading.
4. Repeat, increasing to 60 foot pounds, record the reading.
5. Repeat at 60 foot pounds and record the reading.

Each time you loosen the bolts, measure to be sure that the rod bolts have returned to within .001" of the starting size. If you have a greater variation, get rid of the rod bolts and start with new ones.

When you're conducting final assembly, be sure you use the stretch specified by your rod manufacturer. Attach a rod bolt stretch gauge to the connecting rod bolt and zero it. Use an extra-long box wrench to tighten until the proper stretch is achieved.

### Dial Bore Gauges

- For cylinders, sleeves, large connecting rods and many other gauging jobs
- Diameter range: 2" to 6"
- 12" reach
- Self-aligning and self-centering
- Carbide contact points
- Insulated grip eliminates "drift"
- Includes molded case with extension points & wrenches



Dial Bore Gauge	Jobber	Order No.
.0001" graduations	\$944.99	<b>GA-2121</b>
.0005" graduations	944.99	<b>GA-2125</b>



### Split Ball Bore Gauge

- Dial gauge with large contact area
- Measures quickly & accurately to .0001" (.0025mm)
- Works in threaded or knurled guide IDs
- Range: .280"-.400" • Easy to change contacts
- Order No. **MVG-34** Jobber \$599.99



Mitutoyo

Buy 3 or more boxes of seals (mix & match) and take an extra 10% off jobber



MV-039-10 MV-023-10 MV-091-10 MV-047-10 MV-010-10

## AV&V Hi-Temp Valve Seals for Offroad Applications

- Made from a special Hi-Temp compound, these seals can resist higher temperatures than regular Hi-Temp seals
- 10 per pack

Application	Guide OD	Stem Dia.	Order No.
<b>Honda</b>			
CRF 150R Intake & Exhaust (2007-2012)	.325"	4.5mm	<b>MV-039-10</b>
CRF 250R Intake & Exhaust (2004-2007)	.339"	5.0mm	<b>MV-023-10</b>
CRF 250X Intake & Exhaust (2004-2013)	.339"	5.0mm	<b>MV-023-10</b>
TRX400EX Intake & Exhaust (1999-2013)			
TRX/CRF 450R Intake (2002-2008)	.360"	5.5mm	<b>MV-091-10</b>
TRX/CRF 450R Exhaust (2006-2009)			
TRX/CRF 450R Exhaust (2004-2005)	.339"	5mm	<b>MV-098-10</b>
<b>Yamaha</b>			
YZF 450 Intake & Exhaust (2004-2009)	.325"	4.5mm	<b>MV-039-10</b>
<b>Suzuki</b>			
LTR-450 Intake & Exhaust (2006-2009)	.365"	5.5mm	<b>MV-091-10</b>
<b>Can Am</b>			
DS 450 Intake & Exhaust (2008-2012)	.4360"	6mm	<b>MV-047-10</b>
<b>Kawasaki</b>			
KX 250F Intake (2003-2013)	.294"	4.5mm	<b>MV-010-10</b>

Jobber \$14.99



HVS-6MM HV-7MM HV-7MMOE HVS-421 HVS-531

HV-7MMOE

## AV&V Hi-Temp Valve Seals for V-Twins

- Resist temperatures up to 50° higher than other hi-temp seals
- Evo/TC stock length guides need to be shortened with .423" Valve Seal Cutter (VSC-420312) on page 130

Size	Application	Guide OD	Stem Dia.	Qty.	Jobber	Order No.
6mm	V-Rod	8.5mm	6mm	20	\$18.99	<b>HVS-6MM</b>
7mm	Double Spring	.562"	7.0mm	20	28.99	<b>HV-7MM</b>
7mm	OE Replacement	.562"	7.0mm	20	28.99	<b>HV-7MMOE</b>
.421"	Evo / Twin Cam	.421"	.3125"	20	18.99	<b>HVS-421</b>
.531"	Evo / Twin Cam	.531"	.3125"	20	19.99	<b>HVS-531</b>



HSS-420 HSS-530312 HSS-530341 HSS-562 HSS-625

## OE Style Valve Seals

Application	Guide OD	Stem Dia.	Qty.	Jobber	Order No.
Evo/Twin Cam	.421"	.312"	20	\$21.99	<b>HSS-420</b>
Evo/TC/Iron Head Sportster (Intake)	.530"	.312"	20	21.99	<b>HSS-530312</b>
Iron Head Sportster (Exhaust)	.530"	.341"	20	21.99	<b>HSS-530341</b>
Pan/Shovel Head (1948-79)	.562"	.375"	20	21.99	<b>HSS-562</b>
Shovel Head (1980-84)	.625"	.375"	20	21.99	<b>HSS-625</b>

## Valve Seat Inserts

- For Harley
- Easy to machine
- Effectively dissipate heat for consistent valve sealing
- Hardness increases during engine break-in • Radiused for easy installation



### Replacement Valve Seats For Shovel Head 1200 & 1340

Application	OD	ID	Thickness	Jobber	Order No.
Exhaust	1.944"	1.575"	.400"	\$5.99	<b>HVS-1944</b>
Intake	2.135"	1.750"	.400"	5.99	<b>HVS-2135</b>

### Upsize Seats For Shovel, Evolution & Twin Cam – machining required

OD	ID	Thickness	Jobber	Order No.
1.630"	1.180"	.385"	\$5.99	<b>HVS-1630</b>
1.757"	1.410"	.430"	5.99	<b>HVS-1757</b>
1.882"	1.530"	.410"	5.99	<b>HVS-1882</b>
2.008"	1.610"	.440"	5.99	<b>HVS-2008</b>
2.040"	1.700"	.425"	5.99	<b>HVS-2040</b>
2.070"	1.610"	.460"	5.99	<b>HVS-2070</b>
2.132"	1.800"	.460"	5.99	<b>HVS-2132</b>
2.163"	1.750"	.455"	5.99	<b>HVS-2163</b>

### For Iron Head Sportster

Application	OD	ID	Thickness	Jobber	Order No.
Exhaust	1.757"	1.371"	.315"	\$5.99	<b>HVS-1757S</b>
Intake	2.068"	1.750"	.315"	5.99	<b>HVS-2068</b>

### Universal Repair Seat

OD	ID	Thickness	Jobber	Order No.
28mm	20mm	8.0mm	\$5.99	<b>MVS-14</b>
29mm	21mm	8.5mm	5.99	<b>MVS-18</b>
30mm	22mm	8.5mm	5.99	<b>MVS-22</b>
31mm	23mm	8.5mm	5.99	<b>MVS-26</b>
1.255"	.750"	.437"	5.99	<b>MVS-30</b>
32mm	24mm	8.5mm	5.99	<b>MVS-34</b>
33mm	25mm	8.5mm	5.99	<b>MVS-38</b>
34mm	26mm	8.5mm	5.99	<b>MVS-42</b>
1.381"	.875"	.437"	5.99	<b>MVS-46</b>
1.505"	1.060"	.375"	5.99	<b>MVS-50</b>
1.630"	1.180"	.385"	5.99	<b>MVS-54</b>
1.692"	1.315"	.375"	5.99	<b>MVS-58</b>
1.820"	1.375"	.450"	5.99	<b>HVS-1820</b>
1.880"	1.435"	.410"	5.99	<b>HVS-1880</b>
1.945"	1.375"	.440"	5.99	<b>HVS-1945</b>
2.257"	1.550"	.500"	5.99	<b>HVS-2257</b>

### tech tips

from the tech experts™  
When installing seats preheat head to 400° and freeze the seat for easier installation. Press fit .006" to .008".

### Nickel Chrome Valve Seats on Page 14

## AV&V Seal Drivers

- A must-have tool for installing valve seals • Aluminum

Seal Size	Order No.
4.5mm	<b>VSD-4.5MM</b>
5.0mm	<b>VSD-5MM</b>
5.5mm	<b>VSD-5.5MM</b>
6.0mm	<b>VSD-6MM</b>
7.0mm	<b>VSD-7MM</b>
5/16"	<b>VSD-312</b>
8.0mm	<b>VSD-8MM</b>
3/8"	<b>VSD-375</b>

Jobber \$23.99



## Valve Seal Drivers

- For Harley-Davidson® OE-Style Seals
- Color coded for easy identification by size

Color	Size	Applications	Jobber	Order No.
Red	.420"	Fits HSS-420	\$6.99	<b>VSD-R</b>
Black	.530"/.562"	Fits HSS-530312, HSS-562	6.99	<b>VSD-B</b>
White	.625"	Fits HSS-625	6.99	<b>VSD-W</b>

CLEANING, ASSEMBLY & SAFETY, SHORT BLOCK REBUILDING, IRON HEAD SPORTSTER, CRANKSHAFT/ FLYWHEEL GRINDING, MISCELLANEOUS TOOLS & SUPPLIES, BRAKE & TIRE CHANGING TOOLS, MEASURING TOOLS, V-TWIN & METRIC HARD PARTS



"Our job is to take your order correctly, confirm that the products are in stock and then get the order to shipping right away so that it ships the same day."

- Alyssa, Goodson Customer Service, 1 year of service

## Manganese-Bronze Valve Guides

### Specifically for Harley-Davidson® heads



- Special high-temp Hi-temp O-ring seal • Seal prevents oil from passing between the guide and the head • Smooth lead-in section for best tire changing during installation • CNC machined to exact specifications for each application • Smooth finish prevents damage to ID of receiver holes • Chamfered IDs prevents oil from being scraped away at every stroke of the valve • Guide ID is unfinished and ready to be precision reamed or honed



### High Performance Evolution, Twin Cam & Sportster

- Use with .421" Hi-temp valve seals (HVS-421 or HSS-420) • Shorter for high lift & high flow applications

Size	OD	ID	Intake	Exhaust
Std.	.5625"	.3090"	HVG-5600S	HVG-5700S
.001"	.5635"	.3090"	HVG-5601S	HVG-5701S

Jobber \$8.99



### High Performance Evolution, Twin Cam & Sportster

- Use with .531" Hi-temp valve seals (HVS-531) • Shorter for high lift & high flow applications

Size	OD	ID	Intake	Exhaust
Std.	.5625"	.3090"	HVG-5600	HVG-5700
.001"	.5635"	.3090"	HVG-5601	HVG-5701
.002"	.5645"	.3090"	HVG-5602	HVG-5702
.003"	.5655"	.3090"	HVG-5603	HVG-5703
.004"	.5665"	.3090"	HVG-5604	HVG-5704
.025"	.5875"	.3090"	HVG-5625	HVG-5725

Jobber \$8.99



### Fits 2005 & up High Performance 7mm Twin Cam, Sportster & Buell

- Use with stock style seals or HV-7MM for double spring application
- Tapered and shorter nose for high performance application

Size	OD	ID	Intake	Exhaust
Std.	.5625"	.273"	HVG-6600	HVG-6700
.001"	.5635"	.273"	HVG-6601	HVG-6701
.002"	.5645"	.273"	HVG-6602	HVG-6702

Jobber \$8.99

### Guide Driver for Reduced Diameter Top Valve Guides

We've developed this guide driver specifically for our reduced diameter top valve guides (at left). The unique design eliminates mushrooming. The guide top fits into the groove between the driver and the bushing to both center the guide and drive it into place by putting pressure on the step top of the guide, not the seal area. You MUST use this driver to install these guides.

Order No. VGD-315420 Jobber \$42.99



Additional sizes are available for most guides.  
Call 1-800-533-8010 for information.

### Evolution, Twin Cam & Sportster

- Stock length for replacement
- Use with .530" OE-style valve seals (HSS-530312)
- Same guide fits Intake or Exhaust

Size	OD	ID	Order No.
Std.	.5625"	.3090"	HVG-5500
.001"	.5635"	.3090"	HVG-5501
.002"	.5645"	.3090"	HVG-5502
.003"	.5655"	.3090"	HVG-5503
.004"	.5665"	.3090"	HVG-5504
.015"	.5775"	.3090"	HVG-5515
.025"	.5875"	.3090"	HVG-5525

Jobber \$8.99



### Shovel & Pan Head 1200cc (1948-1979)

- Use with OE-style valve seals (HSS-562)
- Same guide fits Intake or Exhaust

Size	OD	ID	Order No.
Std.	.566"	.375"	HVG-5300
.001"	.567"	.375"	HVG-5301
.002"	.568"	.375"	HVG-5302
.003"	.569"	.375"	HVG-5303
.004"	.570"	.375"	HVG-5304
.006"	.572"	.375"	HVG-5306
.008"	.574"	.375"	HVG-5308
.010"	.576"	.375"	HVG-5310
.012"	.578"	.375"	HVG-5312
.014"	.580"	.375"	HVG-5314
.016"	.582"	.375"	HVG-5316
.018"	.584"	.375"	HVG-5318
.025"	.591"	.375"	HVG-5325

Jobber \$8.99



### V-Rod

- Use with HVS-6mm valve seals

Size	OD	ID	Order No.
Std.	10.03mm	6mm	HVG-7000
.001"	10.07mm	6mm	HVG-7001

Jobber \$8.99



### Shovel Head 1340cc (1979 - 1984)

- Use with OE-style valve seals (HSS-625) • Same guide fits Intake or Exhaust

Size	OD	ID	Order No.
Std.	.625"	.375"	HVG-5400
.001"	.626"	.375"	HVG-5401
.002"	.627"	.375"	HVG-5402
.003"	.628"	.375"	HVG-5403
.004"	.629"	.375"	HVG-5404
.006"	.631"	.375"	HVG-5406
.025"	.650"	.375"	HVG-5425

Jobber \$8.99



### XL 1957 to early 1983

Cast Iron

- Intake ID = .309"
- Use with OE-style valve seal (HSS-530312)
- Exhaust ID = .339"
- Use with OE-style valve seal (HSS-530341)

Size	OD	Intake	Exhaust
Std.	.5645"	HVG-5100C	HVG-5200C
.001"	.5655"	HVG-5101C	HVG-5201C
.002"	.5665"	HVG-5102C	HVG-5202C
.003"	.5675"	HVG-5103C	HVG-5203C

Jobber \$8.99



### Universal Repair Guides

- Manganese Bronze
- Ready to be custom machined

Size	OD	ID	Length	Order No.
7mm	.740"	7mm	2.70"	UVBG-7MM
.313"	.740"	.308"	2.70"	UVBG-308
.375"	.740"	.375"	2.70"	UVBG-372

Jobber \$8.99



CYLINDER HEAD REBUILDING  
CLEANING, ASSEMBLY & SAFETY  
SHORT BLOCK REBUILDING  
CRANKSHAFT/ FLYWHEEL GRINDING  
MISCELLANEOUS TOOLS & SUPPLIES  
BRAKE & TIRE CHANGING TOOLS  
MEASURING TOOLS  
V-TWIN & METRIC HARD PARTS





# High Performance Valves

## Black Tulip® and Chrome Tulip Valves for Harley-Davidson® Engines

These superb valves feature the highest flow levels on the market. They are one piece forged from a racing grade stainless steel alloy and are available in hard black or chrome finish. Each valve has a bearing-quality hardened tip at the end of the stem to prevent premature wear with high-lift applications.

**NOTE:** Single groove keepers can be used on triple groove valves. Install keepers in the upper-most groove. This results in a stronger assembly than OE design.

Application	Type	Head Dia.	OAL	Stem Dia.	Jobber	Black Tulip®	Jobber	Chrome Tulip	
<b>Evo Big Twin &amp; Twin Cam ½" Valves</b>	Exhaust	1.585"	4.525"	0.3106"	\$19.99	HBV-1585 (replaces obsolete HBV-1570)			
	Exhaust	1.610"	4.510"	0.3106"	19.99	HBV-1610D			
	Exhaust	1.700"	4.470"	0.3106"			\$31.99	HCV-1700	
	Exhaust	1.700"	4.535"	0.3106"	31.99	HBV-1700A			
	Intake	1.900"	4.440"	0.3108"	19.99	HBV-1900			
	Intake	1.940"	4.440"	0.3108"	19.99	HBV-1940			
	Intake	1.990"	4.440"	0.3108"	25.99	HBV-1990			
	Intake	2.020"	4.440"	0.3108"	23.99	HBV-2020A			
	Intake	2.020"	4.490"	0.3108"			23.99	HCV-2020	
	Intake	2.060"	4.440"	0.3108"	27.99	HBV-2060A			
<b>7mm Twin Cam, Sportster, Buell Triple &amp; Single Groove Valves</b>	Exhaust	1.575"	4.560"	0.2755"	\$19.99	HBV-1575-7TG	\$19.99	HCV-1575-7TG	
	Exhaust	1.610"	4.545"	0.2755"	19.99	HBV-1610-7TG	19.99	HCV-1610-7TG	
	Intake	1.810"	4.455"	0.2757"	19.99	HBV-1810-7TG	19.99	HCV-1810-7TG	
	Intake	1.850"	4.455"	0.2757"	19.99	HBV-1850-7TG	19.99	HCV-1850-7TG	
	Intake	1.900"	4.455"	0.2757"	19.99	HBV-1900-7TG	19.99	HCV-1900-7TG	
	Intake	1.980"	4.455"	0.2757"	25.99	HBV-1980-7TG			
	Exhaust	1.480"	4.640"	0.3106"	\$19.99	HBV-1480*			
<b>Sportster 883 to 1200 Conversion</b>	Exhaust	1.485"	4.680"	0.2754"	19.99	HBV-1485-7TG	<b>new</b>		
	Intake	1.720"	4.560"	0.3108"	19.99	HBV-1720*	<b>new</b>		
	Exhaust	1.575"	4.620"	7.0mm	19.99	HBV-1576-7TG			
	Exhaust	1.725"	4.580"	0.2754"	19.99	HBV-1725-7TG	<b>new</b>		
	Intake	1.770"	4.480"	0.3108"	23.99	HBV-1770			
	Intake	1.810"	4.480"	7.0mm	23.99	HBV-1811-7TG			
	Intake	1.851"	4.520"	7.0mm	23.99	HBV-1851-7TG			
<b>Sportster 1200 and Buell XB9 / XB12</b>	Exhaust	1.580"	4.575"	0.3106"			\$23.99	HCV-1580	
	Intake	1.812"	4.485"	0.3108"			23.99	HCV-1813	
	Exhaust	1.610"	4.565"	0.3106"	\$27.99	HBV-1610S			
	Exhaust	1.700"	4.635"	0.3106"	23.99	HBV-1700U			
	Intake	2.020"	4.480"	0.3108"	27.99	HBV-2020S			
<b>S&amp;S®, Screaming Eagle® &amp; Ultima® Heads</b>	Intake	2.060"	4.510"	0.3108"			\$27.99	HCV-2060LC	
	Intake	2.100"	4.590"	0.3108"	\$23.99	HBV-2100U			
	Exhaust	1.650"	4.510"	0.3106"	27.99	HBV-1650			
	Intake	2.100"	4.475"	0.3108"	27.99	HBV-2100			
<b>SE® / JIMS® 120 cu. in. Heads</b>	Intake	2.150"	4.480"	0.3108"			\$31.99	HCV-2150	
	Exhaust	34.4mm	116.9mm	0.2346"	19.99	HCV-34.4M			
	Exhaust	35.4mm	116.9mm	0.2346"	19.99	HCV-35.4M			
<b>V-Rod (02 and up) larger stem diameter than stock size for a tighter fit in the guide</b>	Intake	40mm	116.28mm	0.2351"	19.99	HCV-40M			
	Intake	41mm	116.28mm	0.2351"	27.99	HCV-41M			
	Exhaust	35.4mm	116.9mm	0.2346"	27.99	HCV-35-SG			
	Intake	41.0mm	116.28mm	0.2351"	19.99	HCV-41-SG			
<b>Extreme Duty High Flow Replacement Valves (stock length and head diameter)</b>									
Application	Type	Head Dia.	OAL	Stem Dia.	Jobber	Black Tulip®			
Sportster 833 (1986-2003)	Exhaust	1.355"	4.635"	0.3106"	\$19.99	HEV-1355			
Sportster 833 (1986-2003)	Intake	1.590"	4.550"	0.3108"	19.99	HEV-1590			
Sportster 900-1000	Exhaust	1.562"	3.510"	0.3392"	19.99	HEV-3			
Sportster 900	Intake	1.812"	3.600"	0.3110"	19.99	HEV-4			
Sportster 1000 (1970-1984)	Intake	1.940"	3.600"	0.3110"	19.99	HEV-5			
Sportster 1200 (1987-2003)	Exhaust	1.485"	4.560"	0.3106"	19.99	HEV-1485			
Sportster 1200 (1987-2003)	Intake	1.720"	4.480"	0.3108"	19.99	HEV-1720			
Sportster 1200 (1987-2003)	Exhaust	1.785"	4.480"	0.3108"	19.99	HEV-1785 (Oversize)			
Pan Head (1948-1965)	Both	1.750"	3.825"	0.3765"	19.99	HEV-7			
Shovel Head (1966-1984)	Intake	1.940"	3.875"	0.3770"	19.99	HEV-9			
Shovel Head (1966-1984)	Exhaust	1.750"	3.825"	0.3765"	19.99	HEV-7			
Evo 1340 (1984 & up)	Exhaust	1.615"	4.525"	0.3106"	19.99	HEV-10			
Evo 1340 & Twin Cam (1984 & up)	Intake	1.845"	4.455"	0.3108"	19.99	HEV-11			
Twin Cam (1999-2004)	Exhaust	1.570"	4.525"	0.3106"	19.99	HEV-12			

\*additional machining required

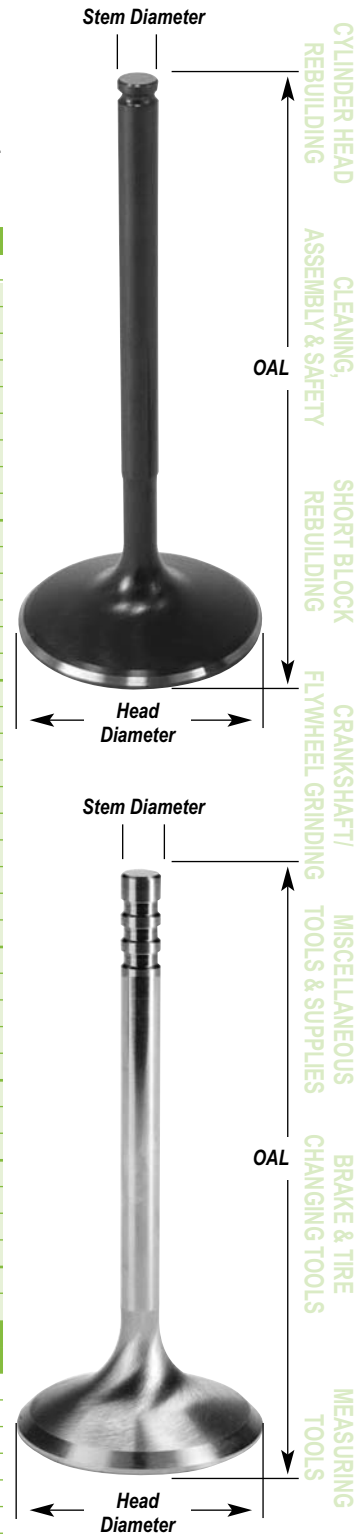

**tech tips**  
from the techxperts™

Always check and confirm running clearances when installing new valves. See Goodson.com for information on Valve Tip Protrusion.

V-TWIN & METRIC HARD PARTS

**Full Service  
FAST!!**



"In addition to the wide selection of tools and supplies found in this catalog, we have access to hundreds of hard-to-find tools not shown due to their specialized nature. If you're looking for a special tool, call us and we'll help you find it."  
- Wendy, Purchasing, 28 years of service

## Evolution, Twin Cam & Sportster

### High Performance Valve Spring Kits for 5/16" valves

- Ultra pure chrome silicon and nickel spring wire
- Extra processing for fatigue resistance
- 1.375" top retainers for better clearance inside rocker covers
- Springs feature chamfered tops to match with smaller retainers
- Complete kit includes 4 springs, retainers, keepers and lower collars



Max. Lift	Seat Pressure	Coil Bind Height	Spring Kit		10° Keepers (4pr)	
			Jobber	Order No.	Jobber	Order No.
<b>Titanium Retainers</b>						
.600"	*155#@1.875"/175#@1.825"	1.080"	\$159.99	HVS-600T	\$12.79	HVK-311A-4
.650"	185#@1.860"/460#@1.160"	1.080"	184.99	HVS-650T	12.79	HVK-311A-4
<b>Steel Retainers</b>						
.600"	*155#@1.875"/175#@1.825"	1.080"	\$ 89.99	HVS-600S	\$12.79	HVK-311A-4
.650"	185#@1.860"/460#@1.160"	1.080"	104.99	HVS-650S	12.79	HVK-311A-4

\*Use Shims to change seat pressure to 175#@1.815"

### Extreme Duty Valve Spring Kit for 5/16" valves

- Specially designed and processed with extra shot peening and nitrided to resist failure under the most extreme conditions when using serious high performance cams such as Bobby Woods
- Recommended for .640" to .675" lift
- Complete kit includes 4 springs, retainers, keepers and lower collars



Max. Lift	Seat Pressure	Coil Bind Height	Spring Kit		10° Keepers (4pr)	
			Jobber	Order No.	Jobber	Order No.
<b>Titanium Retainers</b>						
.675"	185#@1.860"/460#@1.160"	1.080"	\$229.99	HVS-675T	\$12.79	HVK-311A-4

## Pan & Shovel Head

### High Performance Spring Kits

- Silicon and vanadium alloy spring wire
- Increased travel before coil bind
- Complete kit includes 4 springs, retainers and keepers



Max. Lift	Seat Pressure	Coil Bind Height	Spring Kit Order No.	9° Keepers (4pr) Order No.	Springs Only (4) Order No.	Upper Retainers Order No.	Lower Collars Order No.
.470"	155#@1.375"/300#@0.980"	0.850"	HVS-470S	HVK-375-4	HVS-470-4	HVR-530	HHC-4
.530"	155#@1.455"/320#@0.980"	0.850"	HVS-530S	HVK-375-4	HVS-530-4	HVR-530	HHC-4
.625"	175#@1.455"/350#@0.980"	0.850"	HVS-590S	HVK-375-4	HVS-590-4	HVR-530	HHC-4
		Jobber	\$87.99	\$12.79	\$54.99	\$26.99	\$29.99

\*Note: These Pan/Shovel valve springs are not bolt-in items. Always make sure to check the minimum spring spacing and to keep a minimum of .060" before coil bind, at full lift.

Early 1948-1980 heads must be machined to accept AV&V's late style lower collars.

You may need to machine the spring seat with Goodson spring seat cutter #VSS-1680HD and/or use AV&V upper spring collar kit HVR-530 and/or machine the valve seats deeper to get the correct spring spacing.

For reference on late style Shovel (1980-1984), with a 1.630" valve stem protrusion, the spring spacing is +/-1.375".

### Evo & Twin Cam Valve Spring Shims

- Two thicknesses to choose from
- 20 per package

Thick	ID	OD	Jobber	Order No.
.015"	0.60"	1.48"	\$9.99	HVS-5015
.030"	0.60"	1.48"	9.99	HVS-5030
.022"	1.01"	1.44"	9.99	HVS-6022*

\*Use HVS-6022 with HV-7MMOE seals



### V-Twin On-the-Engine Valve Spring Compressor

Replace broken valve springs, install high performance valve springs, remove and replace valve guide seals all without disassembling the bike – just remove the gas tank and get to work. Use on Sportster, Evolution, Twin-Cam and most aftermarket V-Twins. Kit includes valve spring compressor, adaptor for compressing beehive springs, valve seal driver/installer and head pressurizing hose.  
Order No. **CF-HDIF** Jobber \$159.99

**PRICE  
CUT**



CYLINDER HEAD REBUILDING  
CLEANING, ASSEMBLY & SAFETY  
SHORT BLOCK REBUILDING  
CRANKSHAFT/ FLYWHEEL GRINDING  
MISCELLANEOUS TOOLS & SUPPLIES  
BRAKE & TIRE CHANGING TOOLS  
MEASURING TOOLS  
V-TWIN & METRIC HARD PARTS



# Replacement Valve Springs

## Evolution, Twin Cam & Sportster

### High Performance

#### Beehive Valve Spring Kits for 5/16" Valves

- Ultra pure chrome silicon and nickel spring wire
- Extra processing for fatigue resistance
- Resist pressure loss and failure associated with extremely aggressive cams in high compression engines
- Reduce vibration and harmonics
- Complete kit includes 4 springs, retainers, keepers and lower collars



Max. Lift	Seat Pressure	Coil Bind Height	Spring Kit		9° Keepers (4pr)	
			Jobber	Order No.	Jobber	Order No.
<b>Steel Retainers</b>						
.600"	165#@1.860"/384#@1.250"	1.200"	\$99.99	HVS-6000S	\$12.79	HVK-311C-4
.650"	178#@1.860"/385#@1.200"	1.150"	99.99	HVS-6500S	12.79	HVK-311C-4

**NOTE:** .600" Lift Springs – Small end ID: .650", OD: 1.085" / Large end ID: 1.000", OD: 1.445"  
 .650" Lift Springs – Small end ID: .740", OD: 1.185" / Large end ID: 1.055", OD: 1.500"

### 7mm Chromoly Single Groove Retainer & Keeper Kits

- Use with Single Groove Valves or Triple Groove and OE Beehive Springs • Oversized 7° keepers are designed to be stronger than OE keepers • 4 Pc. Set
- Order No. **HVR-7MM-SG** Jobber \$34.79



### Beehive Valve Spring Kits for 7mm Valves

- Ultra pure chrome silicon and nickel spring wire
- Extra processing for fatigue resistance
- Resist pressure loss and failure associated with extremely aggressive cams in high compression engines
- Reduce vibration and harmonics
- Complete kit includes 4 springs, retainers, keepers and lower collars\*

HVS-6000-7SG



HVS-6500-7SG



Max. Lift	Seat Pressure	Coil Bind Height	Spring Kit		9° Keepers (4pr)		Seals	
			Jobber	Order No.	Jobber	Order No.	Jobber	Order No.
<b>Single &amp; Triple Groove</b>								
.600"	165#@1.860"/384#@1.250"	1.200"	\$89.99	*HVS-6000-7SG	\$12.79	HVK-7MMSG-4	\$28.99	HV-7MMOE
.650"	178#@1.860"/385#@1.200"	1.150"	99.99	*HVS-6500-7SG	12.79	HVK-7MMSGC-4	28.99	HV-7MM

**NOTE:** .600" Lift Springs – Small end ID: .650", OD: 1.085" / Large end ID: 1.000", OD: 1.445"  
 .650" Lift Springs – Small end ID: .740", OD: 1.185" / Large end ID: 1.055", OD: 1.500"

\*HVS-6000-7SG does not include lower collars. These spring must be used with HV-7MMOE valve seals

Due to their larger size, HVS-6500-7SG Springs come with their own lower collars and must be used with HV-7MM valve seals.

### Beehive Valve Spring Kits for V-Rod

- Ultra pure chrome silicon and nickel spring wire
- Extra processing for fatigue resistance
- Resist pressure loss and failure associated with extremely aggressive cams in high compression engines
- Reduce vibration and harmonics
- Complete kit includes 8 springs, steel retainers, and 16 triple groove or single groove keepers
- Use with stock lower collars
- Same spec as the Destroyer race version V-Rod



## tech tips

from the techxperts™

To achieve the best results, always use components from the same manufacturer. You'll be amazed at the difference!

Max. Lift	Seat Pressure	Coil Bind Height	Single Groove (8 springs)		Triple Groove (8 springs)		Seals	
			Jobber	Order No.	Jobber	Order No.	Jobber	Order No.
<b>Triple Groove</b>								
.580"	83#@1.500"/280#@0.900"	0.870"	\$189.99	HVS-7000SG	\$199.99	HVS-7000TG	\$18.99	HVS-6MM

**NOTE:** .600" Lift Springs – Small end ID: 0.574", OD: 0.940" / Large end ID: 0.735", OD: 1.100"

CYLINDER HEAD REBUILDING  
CLEANING, ASSEMBLY & SAFETY  
SHORT BLOCK REBUILDING  
CRANKSHAFT/ FLYWHEEL GRINDING  
MISCELLANEOUS TOOLS & SUPPLIES  
BRAKE & TIRE CHANGING TOOLS  
MEASURING TOOLS  
V-TWIN & METRIC HARD PARTS



"You'll get more than great products from us ... you'll also get great value!"  
- Chris, Goodson Shipping/Receiving, 2 years of service

CYLINDER HEAD REBUILDING  
CLEANING, ASSEMBLY & SAFETY  
SHORT BLOCK REBUILDING  
CRANKSHAFT/ FLYWHEEL GRINDING  
MISCELLANEOUS TOOLS & SUPPLIES  
BRAKE & TIRE CHANGING TOOLS  
MEASURING TOOLS  
V-TWIN & METRIC HARD PARTS

### Universal Repair Guides

- Ready to be machined
- Unfinished ID ready to be reamed with AV&V's exclusive carbide reamers (right)
- Manganese bronze

ID	OD	Length	Jobber	Order No.
4.5mm	.620"	2.000"	\$9.49	UVBG-4.5MM
5.0mm	.620"	2.000"	9.49	UVBG-5MM
5.5mm	.620"	2.225"	9.49	UVBG-5.5MM
6.0mm	.620"	2.375"	9.49	UVBG-6MM
7.0mm	.740"	2.700"	8.99	UVBG-7MM
.308"	.740"	2.700"	8.99	UVBG-308
.373"	.740"	2.700"	8.99	UVBG-372
.341"	.740"	2.700"	8.99	UVBG-341



**The more you buy, the more you save!**  
Buy 10 or more and save 10% off jobber



### .423" Valve Seal Cutter

- Evo/Twin Cam
- Will shorten and chamfer the guide top, increasing seal-to-retainer clearance for higher lift camshafts
- Can also be used to modify .530" guides to .421" guides
- Chuck into any portable drill, drill press or seat and guide machine
- Guide OD: .421" (10.7mm)
- Pilot Size: .312" (7.9mm)
- Use **HVS-421** seal (page 125)
- Order No. **VSC-420312** Jobber \$89.99  
more sizes on page 27



### Pan/Shovel Spring Seat Cutting Tool

- Convert Pan & early Shovels to late style Shovel easily
- Allows higher lift on Panheads and early Shovel Heads
- Included spacer stops the cutter at the correct height for uniform spring spacing
- Use with lower spring collars (**HHC-4**) or stock late-style lower spring collars (1980-1984)



Description	OD	ID	Jobber	Order No.
Spring Seat Cutting Tool	1.680"	0.750"	\$84.99	VSS-1680HD
.375" Spring Pad Pilot			27.99	VP-375



### Compression Release Valves

- 2 per pack
- 10 x 1.0mm thread
- High temperature resistant knobs
- Shorter thread sections on **HDCR-10S** and **HDCR-10L** makes installation easier with less drilling required than OE-style



Application	Length	Thread	Jobber	Order No.
Evolution	1.080"	.425"L	\$44.99	HDCR-10S
Twin Cam	1.400"	.425"L	44.99	HDCR-10L
OE Replacement	1.250"	.475"L	44.99	HDCR-10D

### Bronze Reaming Oil

Size	Jobber	Order No.
1 pint	\$ 9.99	BW-303-G
1 Quart	15.99	BW-303A-G
1 Gallon	35.99	BW-305-G



### Solid Carbide Valve Guide Reamers Specifically Designed For Use Only With Bronze Guides

- Features an extended pilot and multi-fluted design so you can size guides perfectly
- One size allows you to fit both intake & exhaust when using AV&V valves and guides
- 300 to 400 RPM is recommended.
- Use with Bronze Reaming Oil (**BW-303A-G**)
- **DO NOT** use on cast iron

Dia.	Jobber	Order No.	Dia.	Jobber	Order No.
4.0mm	\$189.99	HGR-4.0MM	.3140"	\$269.99	HGR-3140
4.5mm	189.99	HGR-4.5MM	8.0mm	269.99	HGR-8MM
5.0mm	189.99	HGR-5.0MM	.3160"	269.99	HGR-3160
5.5mm	189.99	HGR-5.5MM	.3410"	269.99	HGR-3410
6.0mm	269.99	HGR-6MM	.3420"	269.99	HGR-3420
6.5mm	269.99	HGR-6.5MM	.3425"	269.99	HGR-3425
6.6mm	269.99	HGR-6.6MM	.3430"	269.99	HGR-3430
7.0mm	269.99	HGR-7MM	.3435"	269.99	HGR-3435
.2750"	269.99	HGR-2750	.3440"	269.99	HGR-3440
.2761"	269.99	HGR-2761	.3450"	269.99	HGR-3450
.2766"	269.99	HGR-2766	9.0mm	269.99	HGR-9MM
.3100"	269.99	HGR-3100	.3720"	269.99	HGR-3720
.3110"	269.99	HGR-3110	.3730"	269.99	HGR-3730
.3115"	269.99	HGR-3115	.3740"	269.99	HGR-3740
.3120"	269.99	HGR-3120	.3750"	269.99	HGR-3750
.3130"	269.99	HGR-3130	.3777"	269.99	HGR-3777
			.3782"	269.99	HGR-3782

Due to the characteristics of carbide, we can only guarantee the reamer's dimensional accuracy.

### Conversion Calculator

We've tried to convert as many SAE measurements to Metric (and vice versa) as possible. In some cases there hasn't been enough room. If you need to convert a measurement, here are the formulas:

Starting Measurement	Conversion Formula	Converted Measurement
Inches (in)	# Inches x 25.4	Millimeters (mm)
Feet (ft)	# Feet x .0348	Meters (m)
Millimeters (mm)	# Millimeters ÷ 25.4	Inches (in)
Fahrenheit (F)	(5÷9) x (F - 32)	Celsius (C)
Celsius (C)	(9÷5) x (C + 32)	Fahrenheit (F)

Visit [www.goodson.com/blog/2014/04/22/metric-conversion-calculators/](http://www.goodson.com/blog/2014/04/22/metric-conversion-calculators/) for interactive calculators - just plug your numbers into the correct calculator for instant results

# Metric Valve Guide



Additional Applications Online  
at [www.goodson.com](http://www.goodson.com)

## Valve Guides for Metric Engines

- AV&V's Manganese bronze alloy allows tighter clearances for better heat dissipation and longer life
- Tapered and radiused nose for easier installation and better air flow
- Unique Super Grip Valve seal section use either OEM style or hi-temp seals
- CNC machined • Ready to be reamed to size with our carbide reamers (p. 130)
- Can-Am guides available online

Application	Type	OD	ID	OAL	Jobber	Order No.
Honda CRF 150R (2007-2012)	Intake	.3560"	4.50mm	1.260"	\$8.99	MVG-1020-00
	Exhaust	.3560"	4.50mm	1.501"	8.99	MVG-1021-00
CRF 250X (2004-2013)	Intake	.3962"	5.00mm	1.310"	8.99	MVG-1024-00
CRF 250R (2004-2007)	Exhaust	.3963"	5.00mm	1.510"	8.99	MVG-1025-00
TRX 400EX (1999-2013)	Intake	.4352"	5.50mm	1.971"	8.99	MVG-1040-00
TRX 400X (2009-2013)	Exhaust	.4352"	5.50mm	1.971"	8.99	MVG-1040-00
TRX 400EX .001" Oversize (1999-2013)	Intake	.4362"	5.50mm	1.971"	8.99	MVG-1040-01
	Exhaust	.4362"	5.50mm	1.971"	8.99	MVG-1040-01
CRF 450R (2002-2008) and TRX 450R (2006-2013)	Intake	.4357"	5.50mm	1.283"	8.99	MVG-1050-00
	Exhaust	.4358"	5.00mm	1.497"	8.99	MVG-1051-00
TRX 450R (2004-2005)	Intake	.4357"	5.50mm	1.283"	8.99	MVG-1050-00
	Exhaust	.4355"	5.50mm	1.350"	8.99	MVG-1055-00
Kawasaki KX 250F (2003-2006)	Intake	.3765"	4.50mm	1.279"	8.99	MVG-1110-00
Kawasaki KX 250F (2007-2013) & Suzuki RM-Z250 (2004-2006)	Intake	.3765"	4.50mm	1.435"	8.99	MVG-1111-00
	Exhaust	.3765"	4.50mm	1.279"	8.99	MVG-1110-00
Suzuki LTR 450/450Z (2006-2009)	Intake	.4165"	5.50mm	1.220"	8.99	MVG-1210-00
	Exhaust	.4165"	5.50mm	1.220"	8.99	MVG-1210-00
Suzuki LTZ 400 (2000-2012)	Intake	.4170"	5.00mm	1.260"	8.99	MVG-1215-00
Suzuki DRZ400 (2000-2012)	Exhaust	.4170"	5.00mm	1.260"	8.99	MVG-1215-00
Yamaha YFZ 450 (2000-2009), YFZ 450X (2008-2011)	Intake	.3955"	4.50mm	1.068"	8.99	MVG-1310-00
	Exhaust	.3956"	5.00mm	1.065"	8.99	MVG-1311-00
YFZ 450R (2009-2013) 5-Valve						
YFZ 450R (2010-2013) 4-Valve	Intake	.4355"	5.50mm	1.350"	8.99	MVG-1055-00
	Exhaust	.4355"	5.50mm	1.480"	8.99	MVG-1315-00
Grizzly/Raptor 700 (2006-2013)	Intake	.4545"	6.00mm	1.630"	8.99	MVG-1330-00
	Exhaust	.4545"	6.00mm	1.630"	8.99	MVG-1330-00

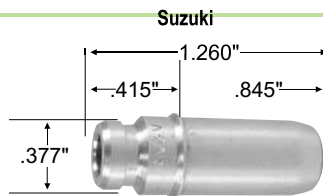

MVG-1215-00

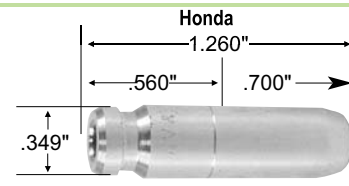

MVG-1020-00

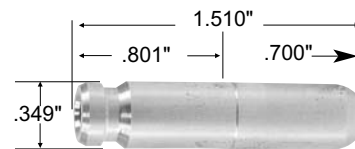

MVG-1021-00

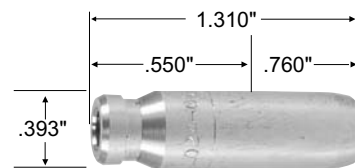

MVG-1024-00

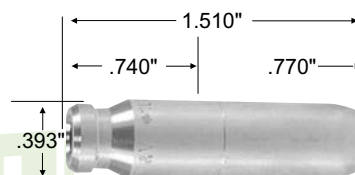

MVG-1025-00

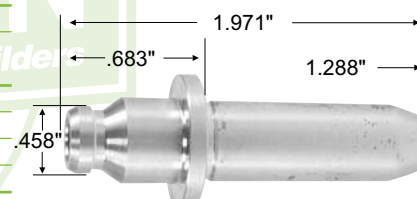

MVG-1040-00

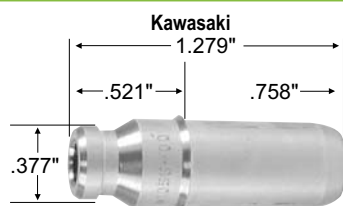

MVG-1110-00

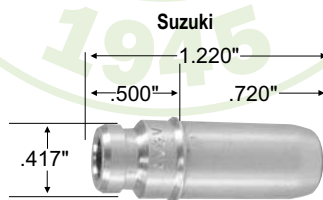

MVG-1210-00

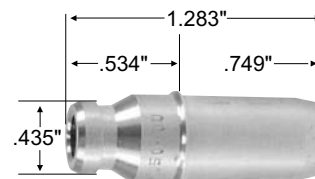

MVG-1050-00

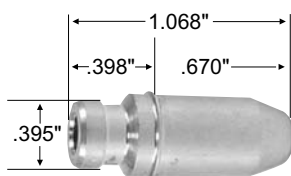

MVG-1310-00

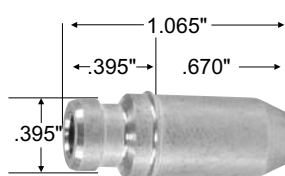

MVG-1311-00



MVG-1051-00

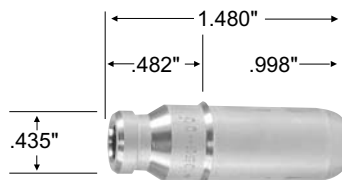

MVG-1315-00

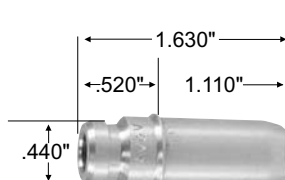

MVG-1330-00

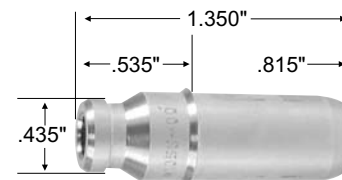

MVG-1055-00

CYLINDER HEAD REBUILDING  
CLEANING, ASSEMBLY & SAFETY  
SHORT BLOCK REBUILDING  
CRANKSHAFT/ FLYWHEEL GRINDING  
MISCELLANEOUS TOOLS & SUPPLIES  
BRAKE & TIRE CHANGING TOOLS  
MEASURING TOOLS  
V-TWIN & METRIC HARD PARTS

From our customers:



"In 2006, I took 3rd place in 2 Wheelspeed Hot Street Class but had valve train failures throughout the year. I have tried several brand named components but still had failures. In 2007, when I started using AV&V components, I had no valve train failures."

-Ken Carlock, Middle of Nowhere Cycles, Tower Hill, Illinois



## AV&V Extreme Duty Valves for Off-Road Motorcycles & ATVs

These superb valves are one-piece forged from a racing-grade stainless steel alloy. Their profile has been optimized to reduce the weight and maximize airflow. Liquid nitriding creates a valve that is smoother and stronger than traditional OE or replacement valves.

Application	Type	Head Dia. (mm)	OAL (mm)	Stem Dia. (mm)	Back Angle	Jobber	Black	Chrome
<b>Honda</b>	Exhaust	26.00	82.15	4.97	20°	\$23.29	<b>MAV-1001</b>	
CRF 250R (2004-2007)	Exhaust	27.00	82.15	4.97	20°	23.29	<b>MAV-1002</b>	
CRF 250X (2004-2013)	Intake	31.00	83.30	4.98	19°	23.29	<b>MAV-1003</b> △	
	Intake	32.00	83.30	4.98	19°	23.29	<b>MAV-1004</b> △	
CRF 250R (2008-2009)	Exhaust	26.00	82.15	4.47	20°	23.29	<b>MAV-1005</b>	
	Intake	31.00	83.30	4.98	19°	23.29	<b>MAV-1003</b> △	
CRF 450R (2002-2008)	Exhaust	31.00	84.35	4.97	20°	21.99	<b>MAV-1011</b>	
	Intake	36.00	84.50	5.48	19°	21.99	<b>MAV-1008</b> △	
	Intake	37.00	84.50	5.48	19°	21.99	<b>MAV-1009</b> △	
CRF 450R (2009-2012)	Exhaust	30.00	80.52	4.97	20°	21.99	<b>MAV-1016</b>	
	Exhaust	31.00	80.64	4.97	20°	21.99	<b>MAV-1017</b>	
	Intake	36.00	78.61	4.98	19°	21.99	<b>MAV-1014</b> △	
	Intake	37.00	78.73	4.98	19°	21.99	<b>MAV-1015</b> △	
TRX 450R (2004-2005)	Exhaust	30.00	84.35	5.47	20°	21.99	<b>MAV-1012</b>	
	Exhaust	31.00	84.35	5.47	20°	21.99	<b>MAV-1013</b>	
	Intake	36.00	84.50	5.48	19°	21.99	<b>MAV-1008</b> △	
	Intake	37.00	84.50	5.48	19°	21.99	<b>MAV-1009</b> △	
TRX 450R (2006-2013)	Exhaust	30.00	84.35	4.97	20°	21.99	<b>MAV-1010</b>	
	Exhaust	31.00	84.35	4.97	20°	21.99	<b>MAV-1011</b>	
	Intake	36.00	84.50	5.48	19°	21.99	<b>MAV-1008</b> △	
	Intake	37.00	84.50	5.48	19°	21.99	<b>MAV-1009</b> △	
<b>Kawasaki</b>	Exhaust	25.00	79.51	4.47	20°	23.29	<b>MAV-1101</b> △	
KX 250F (2003-2013)	Exhaust	26.00	79.51	4.47	20°	23.29	<b>MAV-1102</b> △	
	Intake	31.00	79.51	4.48	19°	23.29	<b>MAV-1103</b> △	
	Intake	32.00	79.51	4.48	19°	23.29	<b>MAV-1104</b> △	
	Intake	30.00	91.44	4.98	19°	21.99	<b>MAV-1111</b>	
Prairie - Brute Force - Teryx	Intake	31.00	91.44	4.98	19°	21.99	<b>MAV-1112</b>	
<b>Suzuki RM-Z250 (2004 - 2006)</b>	Exhaust	25.00	79.51	4.47	20°	23.29	<b>MAV-1101</b> △	
	Exhaust	26.00	79.51	4.47	20°	23.29	<b>MAV-1102</b> △	
	Intake	31.00	79.51	4.48	19°	23.29	<b>MAV-1103</b> △	
	Intake	32.00	79.51	4.48	19°	23.29	<b>MAV-1104</b> △	
RMZ 250 (2007 - 2013)	Exhaust	25.00	80.90	4.47	20°	23.29	<b>MAV-1201</b> △	
	Exhaust	26.00	81.02	4.47	20°	23.29	<b>MAV-1202</b> △	
	Intake	31.00	80.64	4.48	19°	23.29	<b>MAV-1203</b> △	
	Intake	32.00	80.76	4.48	19°	23.29	<b>MAV-1204</b> △	
LTR 450/450Z (2006-2009)	Exhaust	29.00	81.03	5.47	20°	23.29	<b>MAV-1205</b> △	
	Intake	36.00	81.91	5.48	19°	23.29	<b>MAV-1207</b> △	
	Intake	37.00	81.91	5.48	19°	23.29	<b>MAV-1208</b> △	
<b>Yamaha</b>	Exhaust	28.00	75.05	4.97	20°	23.29	<b>MAV-1301</b> △	
YZ 450F (2004-2009)	Exhaust	29.00	75.05	4.97	20°	23.29	<b>MAV-1302</b> △	
YZF 450X (2008-2011)	Intake	27.00	77.20	4.48	19°	23.29	<b>MAV-1303</b> △	
YZF 450R (2009-2013)	Intake	28.00	77.20	4.48	19°	23.29	<b>MAV-1304</b> △	
	Intake	27.00	76.20	4.48	19°	23.29	<b>MAV-1305</b> △ (Center Valve)	
	Intake	28.00	76.20	4.48	19°	23.29	<b>MAV-1306</b> △ (Center Valve)	
	Intake	28.00	76.20	4.48	19°	23.29	<b>MAV-1307</b> △	
YZ 450F (2010 - 2013)	Exhaust	30.00	85.98	5.47	20°	23.29	<b>MAV-1307</b> △	
	Exhaust	31.00	85.98	5.47	20°	23.29	<b>MAV-1308</b> △	
	Intake	37.00	83.58	5.48	19°	23.29	<b>MAV-1310</b> △	
<b>Grizzly/Raptor 700 (2006-2013)</b>	Exhaust	32.00	96.90	5.97	20°	27.79		<b>MAV-1312</b>
	Exhaust	33.00	96.90	5.97	20°	27.79		<b>MAV-1313</b>
	Exhaust	34.00	96.90	5.97	20°	23.99		<b>MAV-1314</b>
	Intake	38.00	103.04	5.98	19°	23.99		<b>MAV-1315</b>
	Intake	39.00	103.04	5.98	19°	27.79		<b>MAV-1316</b>
Intake	40.00	103.04	5.98	19°	27.79		<b>MAV-1317</b>	

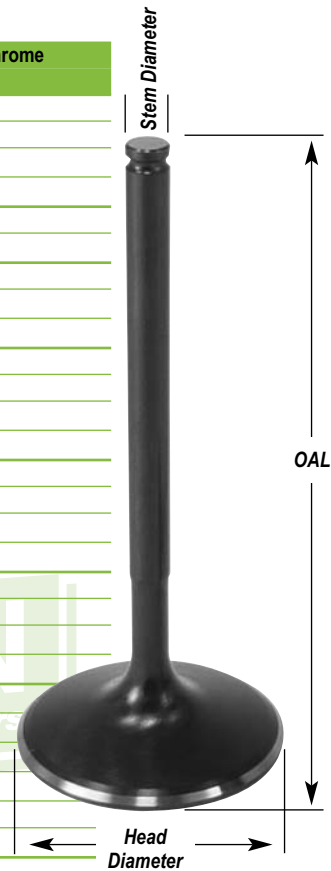

**tech tips**  
from the techxperts™

To achieve the best results, always use components from the same manufacturer.

You'll be amazed at the difference!

△ indicates valves that require use of Extreme Duty Valve Springs (p.133) due to increased pressure requirements.

CYLINDER HEAD REBUILDING  
CLEANING, ASSEMBLY & SAFETY  
SHORT BLOCK REBUILDING  
CRANKSHAFT/ FLYWHEEL GRINDING  
MISCELLANEOUS TOOLS & SUPPLIES  
BRAKE & TIRE CHANGING TOOLS  
MEASURING TOOLS  
V-TWIN & METRIC HARD PARTS

## Extreme Duty Valve Spring Kits

The springs are manufactured from ultra clean high silicon Kobe alloy wire then micro shot peened and nitrated. They are designed to be used with high performance cams or steel valves that replace Titanium valves. **NOTE:** When changing OE titanium valves for steel valves, you must also upgrade your springs for AV&V's Extreme Duty Springs due to the need for higher pressure and toughness.



### Honda CRF 250R (2004-2007) CRF 250X (2004-2013) for Steel Valves

Spring Model	Max. Lift	Seat Pressure	Open Pressure	Coil Bind Height	Retainers	Lower Collars	O.D.	I.D.	Jobber	Order No.
Intake	.380"	38#@1.309"	116#@0.929"	0.870"	Use Stock Units	Use stock or OE	0.760"	0.514"		
Exhaust	.401"	43#@1.525"	168#@1.124"	1.045"	Use Stock Units	Use stock or OE	0.780"	0.510"	\$99.99	MVSK-1006

Valve Shims available for the above. Order No. **MVSS-1010-20** OD: .740" / ID: .440" / Thickness: .020"(Pkg/20 shims) Jobber \$8.99

Intake Springs Only, use part number **MVSK-1006-i** Jobber \$69.99



### Honda CRF 450 (2002-2008) TRX 450 (2006-2013) for Steel or Titanium Valves

Spring Model	Max. Lift	Seat Pressure	Open Pressure	Coil Bind Height	Retainers	Lower Collars	O.D.	I.D.	Jobber	Order No.
Intake	.435**	51#@1.337"	179#@0.902"	0.850"	Use Stock Units	included	0.934"	0.650"		For Steel Valves
Exhaust	.385"	52#@1.416"	179#@1.031"	0.960"	Use Stock Units	included	0.934"	0.650"	\$104.99	MVSK-1015
Intake	.435**	42#@1.337"	179#@0.902"	0.850"	Use Stock Units	included	0.934"	0.650"		For Titanium Vlvs
Exhaust	.385"	52#@1.416"	179#@1.031"	0.960"	Use Stock Units	included	0.934"	0.650"	104.99	MVSK-1015-T

Valve Shims available for the above. Order No. **MVSS-1015-20** OD: .930" / ID: .478" / Thickness: .020" (Pkg/20 Shims) Jobber \$8.99

Intake Springs Only, use part number **MVSK-1015-i** Jobber \$61.99

### Kawasaki KX 250F (2003-2006) and Suzuki RM-Z250 (2004-2006) for Steel Valves

Spring Model	Max. Lift	Seat Pressure	Open Pressure	Coil Bind Height	Retainers	Lower Collars	O.D.	I.D.	Jobber	Order No.
In. / Ex.	.397"	38#@1.317"	130#@.920"	0.835"	Use Stock Units	Use Stock Units	0.800"	0.560"	\$99.99	MVSK-1110

### Kawasaki KX 250F (2007-2013) for Steel Valves

Spring Model	Max. Lift	Seat Pressure	Open Pressure	Coil Bind Height	Retainers	Lower Collars	O.D.	I.D.	Jobber	Order No.
In. / Ex.	.397"	38#@1.317"	130#@.920"	0.835"	included	included	0.800"	0.560"	\$151.99	MVSK-1111

This kit comes with titanium top retainers for the intake springs

### Kawasaki KFX 650/700/750 (2005-2013) Prairie-Brute Force - Teryx for Steel Valves

Spring Model	Max. Lift	Seat Pressure	Open Pressure	Coil Bind Height	Retainers	Lower Collars	O.D.	I.D.	Jobber	Order No.
In. / Ex.	.444"	48#@1.364"	145#@.990"	0.870"	Use Stock Units	Use Stock Units	0.990"	0.690"	\$164.99	MVSK-1116

Intake Only Kit for Steel Valves. Order No. **MVSK-1116-i** Jobber \$87.99

### Suzuki RMZ 450 (2005-2006) LTR 450 (2006-2009) for Steel or Titanium Valves

Spring Model	Max. Lift	Seat Pressure	Open Pressure	Coil Bind Height	Retainers	Lower Collars	O.D.	I.D.	Jobber	Order No.
Intake	.400"	44#@1.160"	141#@0.760"	0.710"	Use Stock Units	Use Stock Units	1.000"	0.730"		For Steel Valves
Exhaust	.400"	34#@1.160"	111#@0.760"	0.705"	Use Stock Units	Use Stock Units	0.910"	0.670"	\$99.99	MVSK-1217
Intake	.400"	37#@1.160"	134#@0.760"	0.710"	Use Stock Units	Use Stock Units	1.000"	0.730"		For Titanium Vlvs
Exhaust	.400"	34#@1.160"	111#@0.760"	0.705"	Use Stock Units	Use Stock Units	0.910"	0.670"	99.99	MVSK-1217-T

Intake valve shims available for the above. Part number **MVSS-1210-20** OD: .942" / ID: .460" / Thickness: .020" (Pkg/20 shims) Jobber \$8.99

Exhaust valve shims available for the above. Part number **MVSS-1211-20** OD: .862" / ID: .460" / Thickness .020" (Pkg/20 shims) Jobber \$8.99

### Yamaha YFZ450 (04-09), YFZ405X (08-11), YFZ450R (09-13)for Steel or Titanium Valves

Valve Type	Max. Lift	Seat Pressure	Open Pressure	Coil Bind Height	Retainers	Lower Collars	O.D.	I.D.	Jobber	Order No.
For Steel	.380"	38#@1.060"	81#@0.680"	0.625"	Use Stock Units	Use Stock Units	0.756"	0.560"	\$99.99	MVSK-1317
For Titanium	.380"	32#@1.060"	75#@0.680"	0.625"	Use Stock Units	Use Stock Units	0.756"	0.560"	99.99	MVSK-1317-T

Valve Shims available for the above. Part number **MVSS-1010-20** OD: .740" / ID: .440" / Thickness .020 (Pkg/20 shims) Jobber \$8.99

### Yamaha Raptor / Grizzly 700 (2006-2013) for Steel Valves

Spring Model	Max. Lift	Seat Pressure	Open Pressure	Coil Bind Height	Retainers	Lower Collars	O.D.	I.D.	Jobber	Order No.
In. / Ex.	.460**	45#@1.450"	195#@0.950"	0.880"	included	included	1.105"	0.742"	\$177.49	MVSK-1318

This kit comes with titanium retainers and jumbo valve keepers.

Valve Shims available for the above. Part number **MVSS-1310-20** OD: 1.090" ID: .460" Thickness: .020" (Pkg/20 shims) Jobber \$8.99

\*Max lift with AV&V Valves is .500", otherwise it is .460" with stock valves.

CYLINDER HEAD REBUILDING  
CLEANING, ASSEMBLY & SAFETY  
SHORT BLOCK REBUILDING  
CRANKSHAFT/ FLYWHEEL GRINDING  
MISCELLANEOUS TOOLS & SUPPLIES  
BRAKE & TIRE CHANGING TOOLS  
MEASURING TOOLS  
V-TWIN & METRIC HARD PARTS

**Full Service  
FAST!**



"We pride ourselves on getting orders to you quickly. We stock a wide variety of products in our Texas service center so that we can get your order to you in 3 days or less."

- William, Texas Customer Service 5 years of service

CYLINDER HEAD REBUILDING  
CLEANING, ASSEMBLY & SAFETY  
SHORT BLOCK REBUILDING  
CRANKSHAFT/ FLYWHEEL GRINDING  
MISCELLANEOUS TOOLS & SUPPLIES  
BRAKE & TIRE CHANGING TOOLS  
MEASURING TOOLS  
V-TWIN & METRIC HARD PARTS



### Manual Valve Spring Compressor

- Weighs only 6 lbs
- High leverage allows for easy, one-hand operation
- Covers a range from 10" high to 8" deep
- Works with most valve-in-head and L-head engines
- Fits truck & tractor engines
- Jaws adjust for small, medium and large springs

Description	Jobber	Order No.
Spring Compressor	\$89.99	CF-140
Replacement Jaw Set	13.99	CF-44
HD Replacement Jaw Set	22.99	CF-44HD



### small engine powersports

### Manual Valve Spring Compressor

- Compress **only** the spring for fast and easy keeper removal
- Fully adjustable steel jaws have maximum opening of 2 1/2" (63.5mm)
- For springs 1/2" (12.7mm) to 1 1/8" (28.6mm) in diameter
- Cadmium finished spring steel construction
- Order No. **CF-131** Jobber \$17.99

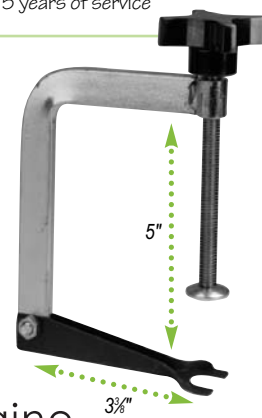

### Manual Valve Spring Compressor For Small Engines

- Once you lock the compressor in position, your hands are free to work
- Includes 2 jaw sets - small, for springs up to 7/8" (22.2mm) and large, for springs up to 1 1/8" 27.0mm)
- Order No. **CF-600** Jobber \$21.99

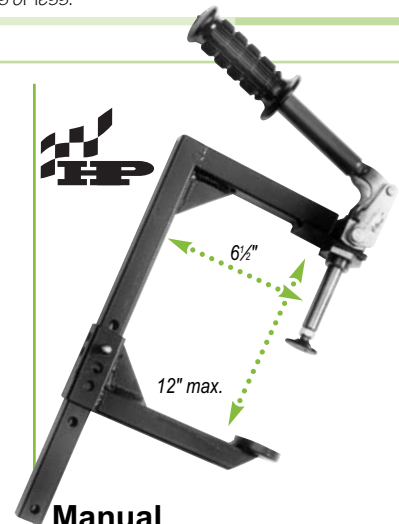

### Manual Valve Spring Compressors

- Handle valve springs from a range of applications
- Welded, gusseted all-steel construction takes plenty of abuse
- Plenty of leverage to compress valve springs

Description	Jobber	Order No.
High Performance Spring Compressor	\$234.99	CF-1500
3/4" Replacement Adaptor for CF-1400	\$34.99	CF-6

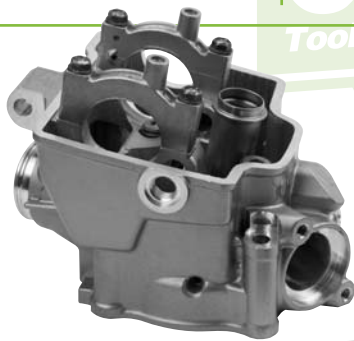

### Small OHV Engine Keeper Removal/Installation Tool

- Easy to use - Uses your own body weight as leverage to remove or install keepers
- Works with 3.5mm to 5.5mm single groove valves only
- Complete set includes a remover with powerful magnet to hold the keepers in place after removal, universal installer to fit valve stems from 3.5 to 5.5mm and two non-slip valve chamber pads

Description	Jobber	Order No.
Keeper Removal Installation Tool	\$99.99	VKI-35
Keeper Magnet - 6 1/8" holder with .170" dia. earth magnets	15.99	VKM-17

Tools and Supplies for Engine Builders



**PRICE CUT**

### Harley® Head Organizer Tray

- Now that you have the head apart, keep it organized and protected
- Virtually unbreakable molded plastic
- Oil and solvent resistant
- Trays stack for easy storage
- 2 1/8" x 14 1/8" x 3" • Order No. **HHD-2** Jobber \$29.99

Dimensional weight applies



### T6 Aluminum Torque Plates

- For most OE Harley-Davidson® engines
- Two sizes to choose from
- Includes top and base plates and mounting hardware

Application	Jobber	Order No.
Evolution & Shovel	\$499.99	HHD-SEV
Twin Cam / V-Rod	499.99	HHD-2CAM





# Head Holders and Stands

## Economy Cylinder Head Holder

- Holds head with either side up
- Tapered pins fit any size head bolt hole and loosen with a twist
- Ideal for guide sizing with ample clearance to remove arbors and reamers
- All steel construction
- Two piece set
- Order No. **HH-100-G** Jobber \$27.99

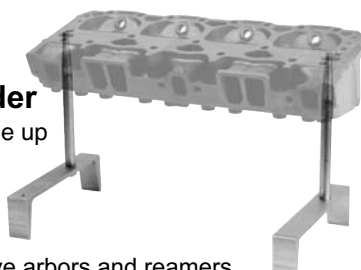

## Ultra-Sturdy Cylinder Head Holder

- 360° stand holds head securely in position
- Tie-rod to prevent tipping
- Slip-resistant neoprene covered rails
- Fits domestic, foreign, truck & motorcycle heads
- 3-piece set
- Order No. **HH-450** Jobber \$99.99

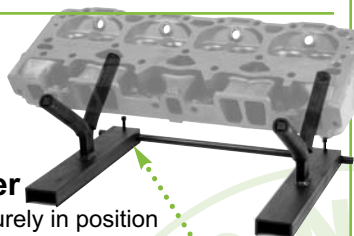

Set screws hold the two pieces firmly in place

## Universal Cylinder Head Holder

- Accommodates all types of cylinder heads
- Sturdy, durable, lightweight aluminum construction
- Slip-resistant neoprene covered rails
- Place heads quickly into any position and rotate them easily through 360°
- Requires no bolts, clamps or adaptors
- 2 piece set • Order No. **HH-200** Jobber \$119.99

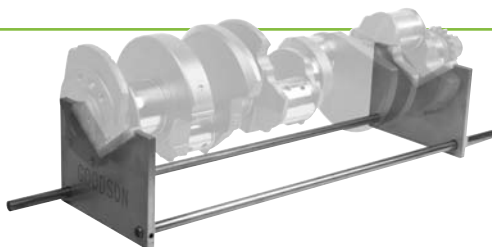
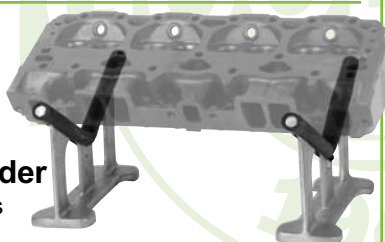

## Professional Measuring & Inspection Stand

- Length adjusts up to 23"
- Rotate work to view or measure
- Solid aluminum frame with self lubricating, corrosion and chemical-resistant wear surfaces
- Order No. **PMIS-30** Jobber \$124.99

**Goodson**  
exclusive

## Steel Double Harley Head Plate

This Double Head Plate takes the universal design of our **HHP-6** Head Plate one step further to accommodate two heads at the same time. Due to its unique mounting system, it fits Shovel, Evolution, Twin Cam, V-Rod, Sportster and Pan heads. The plate is heavy enough for cutting and installing guides and seats. It is designed to be used on a seat and guide machine or Bridgeport-type Mill, including CNC machines. Mounting instructions (with diagrams) for all head types are included. Blackened steel construction. Order No. **HHP-26** Jobber \$749.99



**PRICE CUT**

**Goodson**  
exclusive

## Steel Harley® Head Plate and Head Stand

- Fits Shovel, Evolution, Twin-Cam, V-Rod, Sportster and Pan heads
- Rigid enough for cutting and installing guides and seats
- Adjustable positive stops for leveling and machining
- Use on seat and guide machine and/or head resurfacer
- Includes 2 risers
- Instructions include easy-to-read diagrams for mounting Harley® heads
- Blackened steel

Plate swivels a full 45° either way and is lockable anywhere in between



Description	Jobber	Order No.	Incl.
Complete Unit	\$699.99	<b>HHS-600</b>	▼
Head Stand	399.99	<b>HHS-601</b>	x
Head Plate	389.99	<b>HHP-6</b>	x

## Intake Scribe Ring Kit

- For porting Evo & V-Twin engines (98-07)
- Kit includes 2 flanges, 1 sealing ring and 1 scribe ring
- Easy as 1-2-3
- 1-Bolt to intake port, 2-Scribe around ring, 3-Port to scribe marks
- Optional D-Ring for exhaust port scribing on Evo & V-Twins (98 - 04)

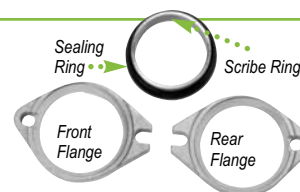

Description	Jobber	Order No.
Intake Scribe Ring Kit	\$64.99	<b>HSR-1650KIT</b>
D-Ring for Exhaust Port Scribing	19.99	<b>HSR-1625D</b>

CYLINDER HEAD REBUILDING  
CLEANING, ASSEMBLY & SAFETY  
SHORT BLOCK REBUILDING  
FLYWHEEL GRINDING  
CRANKSHAFT/ MISCELLANEOUS TOOLS & SUPPLIES  
BRAKE & TIRE CHANGING TOOLS  
MEASURING TOOLS  
V-TWIN & METRIC HARD PARTS

# RAPIDEX

A rapid-use index of **product categories**

## Cylinder Head Rebuilding

Pilots .....	1-3
Valve Seat Work .....	4-21
Valve Refacing .....	22-23
Reamers .....	24-25
Valve Guide Resizing .....	26-28
Valve Guide Replacement .....	29-34
Valve Seal Work .....	35
Valve Spring Work .....	36-42
Cylinder Head Resurfacing .....	43-46
Crack Detection & Repair .....	47-51
Valve Adjustment Discs .....	55
Porting & Polishing .....	57-60

## Cleaning, Assembly & Safety

Cleaning .....	63-68
Wire Wheels & Brushes .....	62-63
Parts Baskets .....	68
Parts Storage & Organizers .....	61, 69
Last Blast Paint & Metal Markers .....	70
Flex-Hones® .....	72

## Index

..... Falls between pages 72 & 73

## Short Block Rebuilding

Cylinder Boring & Honing .....	74-80
Boring Bar Tooling & Supplies .....	74-75
Honing Stones .....	76-80
Rod Honing .....	82-83
Rod & Piston Work .....	84-89
Lifter Bore Tooling .....	91
Camshaft Work .....	92-93

## Crankshaft/Flywheel Grinding

Crankshaft Grinding Wheels .....	94-95
Crankshaft Grinding & Polishing .....	96-100
Flywheel Grinding .....	101-103

## Miscellaneous Tools

Diamond Dresser Tools .....	104-105
Machine Replacement Parts .....	107-109
Technical Manuals & Videos .....	109

## Brake & Tire Changing Tools

Brake Tips & Holders .....	110-111
Brake Lathe Silencers .....	112
Brake Lathe Replacement Parts .....	113-117
Brake Lathe Mounting Adaptors .....	116-117
Tire Changing & Balancing .....	118-119

## Measuring Tools

Calipers & Dial Indicators .....	120
Micrometers .....	121
Dial Bore Gauges .....	122, 124

## V-Twin & Metric Hard Parts

Seats & Seat Inserts .....	125
Valve Guides .....	126
Replacement Valves .....	127
Valve Springs .....	128-129

© Copyright 2015, Goodson Mfg. Co., Inc. All copy and illustrations are copyrighted. Absolutely no mechanical or electronic reproduction or use of any part is allowed without our prior written permission. Goodson reserves the right to correct printing errors. Prices are subject to change without notice.

Hi! You can call me GG (aka Goodson Girl). My picture is hiding in the catalog in 10 (count 'em 10) places, (not including this one). My picture may be VERY small or pointing the other way, but I **am** in the catalog in 10 locations. Find all 10 and you will win a small prize **and** be entered into a drawing for a **Complete Collection of Goodson Wearables!**

To enter, call **1-800-533-8010** or **507-452-1830** or send an email to [webtechs@goodson.com](mailto:webtechs@goodson.com) listing where you found me.

**Start looking and GOOD LUCK!**



### GOODSON Gear

Sport Goodson gear around the shop, at the track or just out and about!

Description	Color	Sizes	Jobber	Order No.
Pre-Shrunk Cotton T-Shirts	White	L, XL, XXL	\$15.99	<b>RW-GTW-"size"</b>
	Black	L, XL, XXL	15.99	<b>RW-GTB-"size"</b>
Caps	Black	adjustable	16.99	<b>RW-GR-CAP</b>
Polyester/Cotton Sweatshirts	Gray	L, XL, XXL	27.99	<b>RW-SS-"size"</b>
	Black	L, XL, XXL	27.99	<b>RW-SB-"size"</b>
Microfiber Jacket	Black	L, XL, XXL	64.99	<b>RW-MFJ-"size"</b>
Can Cooler	Green	n/a	1.99	<b>RW-CC</b>
Stocking Hat	Black	n/a	8.99	<b>RW-SH</b>

**now**

CYLINDER HEAD REBUILDING  
CLEANING, ASSEMBLY & SAFETY  
SHORT BLOCK REBUILDING  
CRANKSHAFT/ FLYWHEEL GRINDING  
MISCELLANEOUS TOOLS & SUPPLIES  
BRAKE & TIRE CHANGING TOOLS  
MEASURING TOOLS  
V-TWIN & METRIC HARD PARTS



**1945** | Hazen Goodson (pictured here with his wife) started selling machine shop tools and supplies in Dallas Texas.

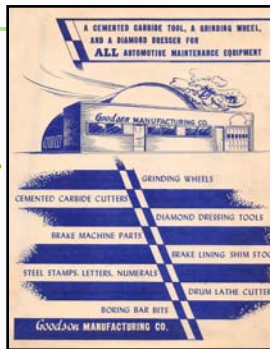

**1950** | The oldest Goodson catalog we've been able to find. This catalog (all six pages) lists many of the same boring bar tools you'll find in today's catalog.

**1959** | Hazen Goodson passed away, leaving the company in the hands of his son-in-law.

### Winona Tool division sold

**1979** | Scott Biesanz purchased the Goodson Tools division from Winona Tools Company.

**1979** | Scott Biesanz purchased the Goodson Tools division from Winona Tools Company.



**1972** | Winona Tool Company bought the assets of Goodson Manufacturing Co. and moved it to Winona, Minnesota. Goodson was operated as a division of Winona Tool Company.

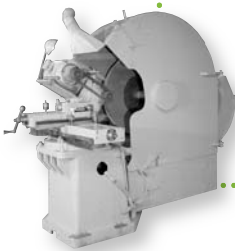

**1981** | Goodson added an in-house crankshaft grinding wheel shaping and sizing department



**1985** | Quickly outgrowing it's first location, Goodson built a new 10,000 sq. ft. building in the Winona Airport Industrial Park. Goodson is still using this building.



**2000** | Goodson introduced the Super Scraper to the automotive aftermarket. The Super Scraper is now available in three sizes.

**1995** | Goodson celebrated 50 years of service to rebuilders and machinists. The Goodson Girl made her first of many appearances.



**1989** | Goodson introduced Minnesota Fast Freeze. It is one of our most popular products to this day.



Now

Then



**2004** | Goodson bought Mach-B Grinding Wheels Shaping & Resizing expanding the capabilities of the production department.



**2010** | Goodson introduced the Hyper-Finish Diamond Sizing System, expanding it in 2011.

### GOODTOOL Now exclusively from Goodson

**2012** | Goodson purchased the assets of Goodtool Brake Service Tools & Supplies, adding a more complete line of brake service tools.



**2014** | Goodson bought the Seat Grinding & Equipment Supplies division of Kwik-Way and is now the product line's exclusive manufacturer.



**2015 and Beyond** | Goodson will continue to be your premier source for engine building tools and supplies!

# GOODSON

Tools and Supplies for Engine Builders

156 Galewski Drive | Winona, MN 55987

Easy Toll-Free Ordering by Phone

**1-800-533-8010**

Toll-Free Fax 24-Hours a Day

**1-888-466-3909**

Order Online!

**www.goodson.com**

## Stay Connected With Goodson



GoodsonToolsAndSupplies



@GoodsonTool



@GoodsonDave



Goodson ShopSupplies

Source Code

Account Number

**KWIK-WAY**  
Seat Grinding Equipment & Supplies

MFG BY

# GOODSON

Tools and Supplies for Engine Builders



See pages NP-2 through NP-5  
for details and ordering  
information